



About Industrial Fittings Sales

Industrial Fittings Sales is a national and Australian owned company who has been supplying brass fittings and accessories to Australian Industries for over 25 years. Our experience in precision manufacturing allows us to deliver a quality product, along with reliable and first class service.

We offer manufacturing solutions for all kinds of components and precision parts. We specialise in repetition engineering of brass components.



Industrial Fittings Sales has the ability to machine your products using the latest CNC machine technology. Our range of products available include many custom made components and over 10000 standard stock lines in Brass, Stainless Steel and Nylon materials.

Our product range includes:

Imperial and metric **Brass** fittings in Compression, Flare, Inverted Flare, Threaded Adaptors, Barbed Hose Tails and Push-In Fittings.



Stainless Steel fittings in Twin Ferrule Design, high and low pressure threaded adaptors in BSP and NPT threads, Barbed Hose Tails and Push-In Style.

Valves in both Brass and Stainless Steel; Ball Valves, Gate Valves, Needle Valves, Swing and Spring Check Valves, Relief Valves, Plug Valves and Manifold Valves.

We also have a full range of other products which include; Air Preparation and Pneumatic Push-In Fittings, full range of Airbrake Fittings, Couplings and Adaptors. Nylon Tube - Imperial & Metric, Airbrake Tube, Suzi Coils, Electro Coils, Polyurethane Tube, Spiral Hoses, Copper and Bund Tubing



Phone (03) 8770 1333.

Fax (03) 8770 1313

Email : sales@ifsvic.com.au

Web Site : www.ifsvic.com.au



ALPHABETICAL INDEX



Product	Page N°	Product	Page N°
AIR PREPARATION & CONTROL		BRASS FITTINGS	
• Air Silencers Brass	131	• Air Silencers	131
• Air Silencers Stainless Steel	149	• Automotive Special Fittings	C10-1
• Compressor Filters	129	• Barbed Fittings	C06-1
• Drop Leg Auto Drain	127	• Breather Vents	C01-4
• Filter Regulators	125	• Capillary Fittings	99
• Hand Taps	128	• Compression Fittings BSP	C01-5
• Lockout Valves	127	• Compression Fittings NPT	C02-3
• Lubricators	126	• Compression Fittings Metric	151
• Mini Filters, Regulators & Regulators	127	• Compression Fittings Other	C03-3
• Miniature Control Valves	129	• Hosetails	C06-1
• Pressure Gauges	132	• Internal Compression Fittings	C05-1
• Pressure Switches	C04-1	• JIC Brass Fittings	C03-3
• Speed Controllers	128	• LPG Fittings	104
• Tool and Compressor Oil	124	• Manifolds BSP	130
AIRBRAKE EQUIPMENT		• Metric Adaptors	C03-1
• Airbrake Tube	87	• Olive Assortment Kits	188
• Electro Coils	88	• Oxy / Acetylene Fittings	104
• Gladhand Couplings	154	• SAE 45° Flare BSP	C01-7
• NTA/1400 Series Airbrake Fittings	158	• SAE 45° Flare NPT	C02-4
• PBR Style Airbrake Fittings	155	• SAE 45° Inverted Flare BSP	C01-10
• Push-In Fittings DOT	229	• SAE 45° Inverted Flare NPT	C02-6
• Quick Couplers CA93 Series	154	• Screwed Brass BSP	C01-1
• Suzi Coils	88	• Screwed Brass NPT	C02-1
• Test Points	C04-9	• Screwed Brass – Other Threads	C03-1
• Truck Valves	C04-9	• Screwed Brass - Plumbing Style	97
• Westinghouse Style Fittings	156	• Solder-On Fittings BSP	C01-11
AIR COUPLINGS & EQUIPMENT		• Swivel Fittings	C12-1
• ARS Couplers	C08-19	• Twin Ferrule Instrumentation Fittings	138
• Atlas Copco Interchange Couplers	C08-14	CABLE TIES & SADDLES	
• Blowguns	C07-1	• Cable Ties - Nylon	C11-1
• CA 93 Series Airbrake Couplers	154	• Cable Ties - Stainless Steel	C11-2
• Camlocks	94	• Cable Tie Tools	C11-2
• Camozzi Mini Couplers	C08-14	• Copper Saddles	C11-3
• CEJN / Air Breathing Couplers	C08-18	• Rubber Lined P Clips	C11-3
• CEJN / EURO Interchange Couplers	C08-12	• Stainless Steel Saddles	C11-3
• Claw Couplers	93	• Tool Clips	182
• Die Mold (PIM) Couplers	C08-16	• Zinc Plated Steel Saddles	C11-2
• Garden Hose Couplers	C08-19	COMPRESSOR COMPONENTS	
• Gladhand Couplings	154	• 90° No Return Valves Valves	C04-4
• ISO B Couplers	C08-15	• Cold Start Valves	C04-2
• Jamec Couplers	C08-1	• Compressor Check Valves	C04-2
• Nitto Couplers	C08-3	• Compressor Filters	129
• Polyurethane Spiral Hose	170	• Compressor and Tool Oil	124
• Ryco Couplers	C08-13	• Filter Regulators	125
• Ryco 200 Interchange Couplers	C08-12	• In Tank Check Valves	C04-3
• Tema Diving Couplings	C08-17	• Load Genies	C04-2
• Tema Hydraulic Couplings	C08-17	• Pilot Valves	C04-4
• US Industrial Interchange Couplers	C08-15	• Pressure Gauges	132



ALPHABETICAL INDEX





Product	Page N°	Product	Page N°
COMPRESSOR COMPONENTS (cont)		INFORMATION	
• Pressure Switches	C04-1	• Category Index	5
• Relief Valves (Bourke)	C04-6	• Terms & Conditions of Sale	232
• Relief Valves (Imported)	C04-2		
HOSE, TUBE & REELS		LUBRICATION EQUIPMENT	
• Air Hose	76	• Grease Guns	187
• Air Seeder Hose	83	• Grease Gun Accessories	187
• Airbrake Nylon Tube	87	• Grease Nipples	184
• Barflo Industrial Hose	85	• Grease Nipple Assortments	190
• Bundy Tube	172	• Grease Nipple Dust Covers	186
• Clear Vinyl Tube	78	• Oil Nipples	187
• Copper Tube	171	• Tool and Compressor Oil	124
• Divers Air Breathing Hose	77		
• Drinking Water Hose	82	MISCELLANEOUS PRODUCTS	
• Electro Coils	88	• Electrical Reels	168
• FEP140 Tube	92	• L.E.D. Light	201
• Fire Reel Hose	79	• Safety Barrier Reels	168
• Garden Hose	80		
• Hose Reels Retractable	166	PLASTIC FITTINGS	
• Hose Reels Manual	169	• Acetal Tube Fittings	C09-1
• Hot Wash Hose	82	• Nylon Hosetails	C09-5
• Layflat Hose	82	• Nylon Screwed Fittings	C09-2
• L.P.G. Hose	83		
• Nylon Tube Industrial	86	PLUMBING FITTINGS	
• Pesticide Hose	79	• Capillary Fittings - Brass	99
• Polyethylene (LDPE) Tube	92	• Capillary Fittings - Copper	100
• Polyurethane Spiral Hose	170	• Copper Compression Fittings	103
• Polyurethane Tube	89	• Flare Fittings BSP 60°	101
• PTFE Tube	90	• Nylon Olive Compression Fittings	102
• Silicone Tube	91	• Screwed Brass	97
• Split Corrugated Tube	85		
• Suction Hose	83	PRESSURE GAUGES	
• Stainless Steel Tube	172	• Bi-Metallic Thermometers	133
• Suzi Coils	88	• Dry Pressure Gauges	132
• Teflon (PTFE) Tube	90	• Liquid Filled Pressure Gauges	136
• Washdown Hose	81	• Stainless Steel Pressure Gauges	136
		• Vacuum Gauges	132
HOSE CLAMPS		PUSH-IN FITTINGS	
• Brass Hose Ferrules	183	• Airbrake DOT Fittings	229
• Cobra Style Clamps	174	• Hand Taps	128
• Mini Clamps	174	• Push-In Fittings NP Brass Imperial	111
• Rubber Lined P Clips	C11-3	• Push-In Fittings NP Brass Metric	112
• Super Clamps W1	179	• Push-In Fittings Stainless Steel Imperial	115
• Supra Clamps	180	• Push-In Fittings Stainless Steel Metric	116
• Tool Clips	182	• Push-In Fittings Standard Imperial	105
• Two Ear Clips (O-Clips)	173	• Push-In Fittings Standard Metric	107
• Two Ear Clips (O-Clips) Assortments	190	• Speed Controllers	128
• Worm Drive Clamps	175		



ALPHABETICAL INDEX



Product	Page N°	Product	Page N°
STAINLESS STEEL FITTINGS		TYRE INFLATION & EQUIPMENT	
• 150lb Hosetails	150	• Tyre Inflators	C07-5
• 150lb Screwed Fittings	147	• Tyre Chucks	C07-6
• Compression Fittings	142	• Tyre Gauges	C07-6
• Convoluted Hose Ends	227	• Tyre Valve Tools	C07-5
• DBF Part Number System	209	VALVES & TAPS	
• DBF Push on Tails	215	• Ball Valves Brass	160
• DBF Screwed Adaptors	216	• Ball Valves Brass 3 way	162
• DBF Swage Ferrules	214	• Ball Valves PVC	161
• DBF Swage Tails	210	• Ball Valves Stainless	163
• Dowty Seals	226	• Bibcocks Brass	161
• JIC Nut & Sleeve	226	• Check Valves	164
• Push-In Fittings	115	• Cold Start Valves	C04-2
• Silencers	149	• Compressor Check Valves	C04-3
• Swivel Fittings	C12-1	• Drain Cocks	C04-7
• Twin Ferrule Instrumentation Fittings	142	• Foot Valves	165
STEEL & GALVANISED FITTINGS		• Gate Valves	165
• Black Steel Fittings	206	• Hand Taps	128
• Gal Mal Screwed Fittings	202	• Lever Taps – Brass	C04-8
• Galvanised Pipe Pieces	205	• Load Genies	C04-2
STORAGE SYSTEMS		• Mini Ball Valves	160
• Multi Stala Storage System	228	• Miniature Control Valves	129
THREAD SEALANTS & LOCKERS		• Needle Valves – Brass	C04-7
• Anti-Seize	118	• Pressure Switches	C04-1
• Bondloc Adhesives	121	• Push-Pull Taps	C04-8
• Bondloc Gasketing	122	• Relief Valves (Bourke)	C04-6
• Bondloc Retainers	120	• Relief Valves (Imported)	C04-2
• Bondloc Thread Lockers	119	• Speed Controllers	128
• Bondloc Thread Sealants	118	• Tank (Schrader) Valves	C04-8
• Dowty Seals Stainless	226	• Truck Valves	C04-9
• Hand Cleaners	120	• Y-Strainers	165
• Silicone Sealants	121	Water Nozzles and Equipment	
• Teflon Tape	124	• Fire Hose Nozzles	C07-4
TOOLS		• Washdown Guns	C07-4
• Cable Tie Tools	C11-2	 INDUSTRIAL FITTINGS SALES (Vic) PTY LTD. 	
• Cobra Style Pincers	174	16-18 SMEATON AVENUE DANDENONG SOUTH. VICTORIA 3175	
• Deburring Tools	193	Phone (03) 8770 1333 Fax (03) 8770 1313	
• Ear Clip Pincers	173	Email : sales@ifsvic.com.au Web Site : www.ifsvic.com.au	
• Flaring Tools	198	Opening Hours : 8:30 AM to 5:00 PM. Mon- Fri	
• Flexdrivers for Worm Drive Clamps	175		
• Nylon Tube Cutter	201		
• Plastic Pipe Cutter	201		
• Tube Cutters	191		
• Tube Benders	194		
• Tubing Tool Kits	201		



CATEGORY INDEX



Category	Description	Pages
1	Standard Brass Fittings. BSP Threads and Tube to Tube Fittings	C01-1 to C01-11
2	Standard Brass. NPT Threads	C02-1 to C02-6
3	Standard Brass. Other Threads including metric and JIC	C03-1 to C03-3
4	Needle Valves & Taps, Compressor Valves, Truck Valves and Test Points	C04-1 to C04-9
5	Internal Compression Fittings	C05-1 to C05-2
6	Brass Hosetails. All Threads	C06-1 to C06-3
7	Blowguns and Tyre Equipment	C07-1 to C07-6
8	Quick Couplers	C08-1 to C08-19
9	Nylon / Acetal Fittings	C09-1 to C09-6
10	Automotive Special Fittings	C10-1
11	Cable Ties, Saddles and Rubber Lined P Clips	C11-1 to C11-3
12	Swivel Fittings	C12-1
13	PVC Hose	76-85
14	Nylon, PE, PU, Teflon and Silicone Tube	86-92
15	Claw Couplers	93
16	Camlocks	94-96
17	Plumbing Fittings	97-103
18	Oxy Acetylene and LPG Fittings	104
20	Pushin Fittings Standard	105-110
21	Pushin Fittings Nickel Plated Brass	111-114
21	Pushin Fittings Stainless Steel	115-117
24	Thread Sealants	118-124
26	FRL and Air Accessories	125-131
27	Pressure Gauges	132-137
29	Twin Ferrule Instrumentation Fittings	138-146
31	Stainless 150lb Fittings	147-150
32	Metric Compression Fittings	151-153
33	PBR Airbrake Fittings & Couplers	154-155
34	Westinghouse Airbrake Fittings	156-157
36	NTA / 1400 Series Airbrake Fittings	158-159
37	Ball Valves	160-163
38	Gate & Check Valves	164-165
40	Retractable and Manual Reels	166-169
43	Polyurethane Coil Hoses	170
45	Copper & Bundy Tube	171-172
46	Stainless Tube	172
50	Hose Clamps	173-183
54	Grease Nipples	184-186
55	Oil Nipples	187
56	Lubrication Accessories	187
64	Assortment Kits	188-190
65	Tubing Tools	191-201
70	Gal Mal Fittings & Pipe Pieces	202-205
71	Black Steel Fittings	206-208
75	DBF Stainless Hydraulic Fittings	209-227
77	Multi Stala Storage Bins	228
88	DOT Push-in Fittings	229-231

STANDARD BRASS - BSP Screwed Fittings. (Category 1)

PRESSURE: Medium pressure ratings around 3500kpa/500psi decreasing as sizes increase and depending on the medium.
TEMPERATURE: 0°C to 120°C
TYPICAL USES: Mostly to join or adapt other fittings or pipe.

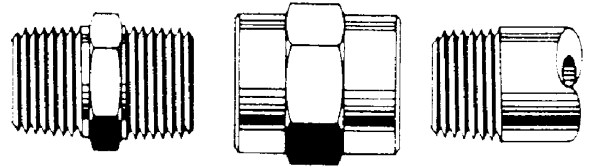

BSPT and BSPT THREAD CHART

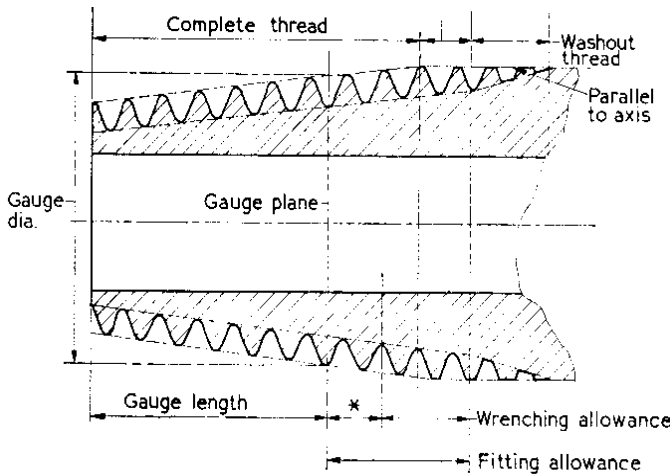

Size	Pitch TPI	Male Thread OD		Female Thread ID	
		mm	inch	mm	inch
1/8	28	9.7	0.38	8.6	0.34
1/4	19	13.2	0.52	11.4	0.45
3/8	19	16.7	0.66	15.0	0.59
1/2	14	21.0	0.83	18.6	0.73
5/8	14	22.9	0.90	20.6	0.81
3/4	14	26.4	1.04	24.1	0.95
1"	11	33.2	1.31	30.3	1.19
1.1/4	11	41.9	1.65	39.0	1.53
1.1/2	11	47.8	1.88	44.8	1.77
2"	11	59.6	2.35	56.7	2.23
2.1/2	11	75.2	2.96	72.2	2.84
3"	11	87.9	3.46	84.9	3.34
4"	11	113.0	4.45	110.1	4.33



#24 Reducing Bush

Code	Male	Female
0124-0402	1/4 BSPT	1/8 BSP
0124-0602	3/8 BSPT	1/8 BSP
0124-0604	3/8 BSPT	1/4 BSP
0124-0802	1/2 BSPT	1/8 BSP
0124-0804	1/2 BSPT	1/4 BSP
0124-0806	1/2 BSPT	3/8 BSP
0124-1202	3/4 BSPT	1/8 BSP
0124-1204	3/4 BSPT	1/4 BSP
0124-1206	3/4 BSPT	3/8 BSP
0124-1208	3/4 BSPT	1/2 BSP
0124-1604	1" BSPT	1/4 BSP
0124-1606	1" BSPT	3/8 BSP
0124-1608	1" BSPT	1/2 BSP
0124-1612	1" BSPT	3/4 BSP

Larger sizes available in Category 17 Plumbing Range.



#24P Parallel Reducing Bush

Code	Male	Female
0124P-0402	1/4 BSPP	1/8 BSP
0124P-0602	3/8 BSPP	1/8 BSP
0124P-0604	3/8 BSPP	1/4 BSP
0124P-0804	1/2 BSPP	1/4 BSP
0124P-0806	1/2 BSPP	3/8 BSP
0124P-1206	3/4 BSPP	3/8 BSP
0124P-1208	3/4 BSPP	1/2 BSP



#25E M&F Compact Elbow

Code	Male	Female
0125-02	1/8 BSPT	1/8 BSP
0125-04	1/4 BSPT	1/4 BSP
0125-06	3/8 BSPT	3/8 BSP
0125-08	1/2 BSPT	1/2 BSP



#25EL M&F Extruded Elbow

Code	Male	Female
0125EL-02	1/8 BSPT	1/8 BSP
0125R-0204	1/8 BSPT	1/4 BSP
0125R-0402	1/4 BSPT	1/8 BSP
0125EL-04	1/4 BSPT	1/4 BSP
0125R-0406	1/4 BSPT	3/8 BSP
0125R-0604	3/8 BSPT	1/4 BSP
0125EL-06	3/8 BSPT	3/8 BSP
0125EL-08	1/2 BSPT	1/2 BSP
0125EL-12	3/4 BSPT	3/4 BSP

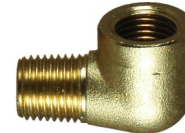

#25C M&F Cast Elbow

Code	Male	Female
0125C-02	1/8 BSPT	1/8 BSP
0125C-04	1/4 BSPT	1/4 BSP
0125C-06	3/8 BSPT	3/8 BSP
0125C-08	1/2 BSPT	1/2 BSP
0125C-12	3/4 BSPT	3/4 BSP

Larger sizes available in Category 17 Plumbing Range.



#25D 45° M&F Elbow

Code	Male	Female
012545-02	1/8 BSPT	1/8 BSP
012545R-0204	1/8 BSPT	1/4 BSP
012545-04	1/4 BSPT	1/4 BSP
012545R-0604	3/8 BSPT	1/4 BSP
012545-06	3/8 BSPT	3/8 BSP
012545-08	1/2 BSPT	1/2 BSP
012545-12	3/4 BSPT	3/4 BSP



#24FBH Bulkhead Fitting is now #80

#24PR Port Reducer is now #81

STANDARD BRASS - BSP Screwed Fittings. (Category 1)



#26
Hex
Socket

Code	Female
0126-02	1/8 BSP
0126-04	1/4 BSP
0126-06	3/8 BSP
0126-08	1/2 BSP
0126-12	3/4 BSP
0126-16	1" BSP

Larger sizes available in Category 17 Plumbing Range.



#27
Hex
Nipple

Code	Male
0127-02	1/8 BSPT
0127-04	1/4 BSPT
0127-06	3/8 BSPT
0127-08	1/2 BSPT
0127-12	3/4 BSPT
0127-16	1" BSPT
0127P-04	1/4 BSPP

Larger sizes available in Category 17 Plumbing Range.



#28
Long Hex
Nipple

Code	Male	Length
0128-0224	1/8 BSPT	1.1/2
0128-0232	1/8 BSPT	2"
0128-0248	1/8 BSPT	3"
0128-0424	1/4 BSPT	1.1/2
0128-0432	1/4 BSPT	2"
0128-0440	1/4 BSPT	2.1/2
0128-0448	1/4 BSPT	3"
0128-0464	1/4 BSPT	4"
0128-0632	3/8 BSPT	2"
0128-0648	3/8 BSPT	3"
0128-0840	1/2 BSPT	2.1/2

Screwed Adaptors also available in stainless steel, gal mal, black steel and nylon



#29
Reducing
Socket

Code	Female	Female
0129-0402	1/4 BSP	1/8 BSP
0129-0602	3/8 BSP	1/8 BSP
0129-0604	3/8 BSP	1/4 BSP
0129-0802	1/2 BSP	1/8 BSP
0129-0804	1/2 BSP	1/4 BSP
0129-0806	1/2 BSP	3/8 BSP
0129-1204	3/4 BSP	1/4 BSP
0129-1206	3/4 BSP	3/8 BSP
0129-1208	3/4 BSP	1/2 BSP
0129-1612	1" BSP	3/4 BSP



#33
Hex
Cap

Code	Female
0133-02	1/8 BSP
0133-04	1/4 BSP
0133-06	3/8 BSP
0133-08	1/2 BSP
0133-12	3/4 BSP
0133-16	1" BSP

Larger sizes available in Category 17 Plumbing Range.



#34C
Female Cast
Elbow

Code	Female
0134C-02	1/8 BSP
0134C-04	1/4 BSP
0134C-06	3/8 BSP

Larger sizes available in Category 17 Plumbing Range.



#34E
Female
Extruded Elbow

Code	Female
0134-02	1/8 BSP
0134-04	1/4 BSP
0134-06	3/8 BSP
0134-08	1/2 BSP



#34D
45° Female
Elbow

Code	Female
013445-02	1/8 BSP
013445-04	1/4 BSP
013445-06	3/8 BSP



#35C
Female
Cast Tee

Code	Female
0135C-02	1/8 BSP
0135C-04	1/4 BSP
0135C-06	3/8 BSP

Larger sizes available in Category 17 Plumbing Range.



#35E
Female
Tee

Code	Female
0135-02	1/8 BSP
0135-04	1/4 BSP
0135-06	3/8 BSP
0135-08	1/2 BSP
0135-12	3/4 BSP



#35M
Male
Tee

Code	Male
0135M-02	1/8 BSPT
0135M-04	1/4 BSPT
0135M-06	3/8 BSPT
0135M-08	1/2 BSPT



#35B
Male Branch
Tee

Code	Male	Female
0135B-02	1/8 BSPT	1/8 BSP
0135B-04	1/4 BSPT	1/4 BSP
0135B-06	3/8 BSPT	3/8 BSP
0135B-08	1/2 BSPT	1/2 BSP

STANDARD BRASS - BSP Screwed Fittings. (Category 1)



#35R
Male Run
Tee

Code	Male	Female
0135R-02	1/8 BSPT	1/8 BSP
0135R-04	1/4 BSPT	1/4 BSP
0135R-06	3/8 BSPT	3/8 BSP
0135R-08	1/2 BSPT	1/2 BSP



#37
Female
Cross

Code	Female
0137-02	1/8 BSP
0137-04	1/4 BSP
0137-06	3/8 BSP
0137-08	1/2 BSP
0137-12	3/4 BSP



#38
Parallel Coned x
Tapered Nipple

Code	Male	Male
0138-0202	1/8 BSPP	1/8 BSPT
0138-0402	1/4 BSPP	1/8 BSPT
0138-0404	1/4 BSPP	1/4 BSPT
0138-0406	1/4 BSPP	3/8 BSPT
0138-0602	3/8 BSPP	1/8 BSPT
0138-0604	3/8 BSPP	1/4 BSPT
0138-0606	3/8 BSPP	3/8 BSPT
0138-0608	3/8 BSPP	1/2 BSPT
0138-0806	1/2 BSPP	3/8 BSPT
0138-0808	1/2 BSPP	1/2 BSPT



#38F
Parallel Coned x
Female

Code	Male	Female
0138F-0404	1/4 BSPP	1/4 BSP
0138F-0406	1/4 BSPP	3/8 BSP
0138FC-0406	1/4 BSPP	3/8 SAE



#39
Parallel Coned
Hex Nipple

Code	Male	Male
0139-02	1/8 BSPP	1/8 BSPP
0139-04	1/4 BSPP	1/4 BSPP
0139R-0604	3/8 BSPP	1/4 BSPP
0139-06	3/8 BSPP	3/8 BSPP
0139-08	1/2 BSPP	1/2 BSPP



#45
Retaining
Nut

Code	Female
0145-02	1/8 BSP
0145-04	1/4 BSP
0145-06	3/8 BSP
0145-08	1/2 BSP
0145-12	3/4 BSP
0145-16	1" BSP



#48
Male
Elbow

Code	Male	Male
0148-02	1/8 BSPT	1/8 BSPT
0148R-0402	1/4 BSPT	1/8 BSPT
0148-04	1/4 BSPT	1/4 BSPT
0148R-0604	3/8 BSPT	1/4 BSPT
0148-06	3/8 BSPT	3/8 BSPT
0148R-0806	1/2 BSPT	3/8 BSPT
0148-08	1/2 BSPT	1/2 BSPT
0148-12	3/4 BSPT	3/4 BSPT

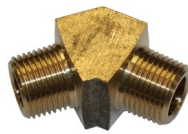

#48D
45° Male
Elbow

Code	Male
014845-02	1/8 BSPT
014845-04	1/4 BSPT
014845-06	3/8 BSPT



#50B Male Tee is
now #35M



#64
Hollow
Hex Plug

Code	Male
0164-02	1/8 BSPT
0164-04	1/4 BSPT
0164-06	3/8 BSPT
0164-08	1/2 BSPT
0164-12	3/4 BSPT
0164-16	1" BSPT

Larger sizes available in Category 17 Plumbing Range.



#64S
Solid
Hex Plug

Code	Male
0164S-02	1/8 BSPT
0164S-04	1/4 BSPT
0164S-06	3/8 BSPT
0164S-08	1/2 BSPT
0164S-12	3/4 BSPT
0164S-16	1" BSPT



#64IH
Internal
Hex Plug

Code	Male
0164IH-02	1/8 BSPT
0164IH-04	1/4 BSPT
0164IH-06	3/8 BSPT
0164IH-08	1/2 BSPT
0164IH-12	3/4 BSPT
0164IH-16	1" BSPT



#64P
Parallel
Hex Plug

Code	Male
0164P-02	1/8 BSPP
0164P-04	1/4 BSPP
0164P-06	3/8 BSPP
0164P-08	1/2 BSPP
0164P-16	1" BSPP

STANDARD BRASS - BSP Screwed Fittings. (Category 1)



#71
Tank
Collar

Code	Female	Diam
0171-0208	1/8 BSP	1/2
0171-0410	1/4 BSP	5/8
0171-0614	3/8 BSP	7/8
0171-0816	1/2 BSP	1"



#72
M&F
Adaptor

Code	Female	Male
0172-0202	1/8 BSP	1/8 BSPT
0172-0402	1/4 BSP	1/8 BSPT
0172-0404	1/4 BSP	1/4 BSPT
0172-0602	3/8 BSP	1/8 BSPT
0172-0604	3/8 BSP	1/4 BSPT
0172-0606	3/8 BSP	3/8 BSPT
0172-0802	1/2 BSP	1/8 BSPT
0172-0804	1/2 BSP	1/4 BSPT
0172-0806	1/2 BSP	3/8 BSPT
0172-0808	1/2 BSP	1/2 BSPT
0172-1204	3/4 BSP	1/4 BSPT
0172-1206	3/4 BSP	3/8 BSPT
0172-1208	3/4 BSP	1/2 BSPT
0172-1212	3/4 BSP	3/4 BSPT
0172-1612	1" BSP	3/4 BSPT
0172-1616	1" BSP	1" BSPT

Larger sizes available in Category 17 Plumbing Range.



#72L
Long M&F
Adaptor

Code	Thread	Length
0172L-0224	1/8 BSPT	1.1/2
0172L-04040	1/4 BSPT	40mm
0172L-04085	1/4 BSPT	85mm
0172L-04125	1/4 BSPT	125mm



#72RS
Restricted M&F
Adaptor

Code	Female	Male
0172RS-0202-1	1/8 BSP	1/8 BSPT

With 1mm Orifice



#73
Reducing
Nipple

Code	Male	Male
0173-0402	1/4 BSPT	1/8 BSPT
0173-0602	3/8 BSPT	1/8 BSPT
0173-0604	3/8 BSPT	1/4 BSPT
0173-0802	1/2 BSPT	1/8 BSPT
0173-0804	1/2 BSPT	1/4 BSPT
0173-0806	1/2 BSPT	3/8 BSPT
0173-1204	3/4 BSPT	1/4 BSPT
0173-1206	3/4 BSPT	3/8 BSPT
0173-1208	3/4 BSPT	1/2 BSPT
0173-1608	1" BSPT	1/2 BSPT
0173-1612	1" BSPT	3/4 BSPT

Larger sizes available in Category 17 Plumbing Range.



#74
Hex
Locknut

Code	Female
0174-02	1/8 BSP
0174-04	1/4 BSP
0174-06	3/8 BSP
0174-08	1/2 BSP
0174-12	3/4 BSP
0174-16	1" BSP
0174C-03	3/8x24
0174C-04	7/16x24
0174C-05	1/2x24
0174C-06	9/16x24

Larger sizes available in Category 17 Plumbing Range.



#75
Female
Y-Piece

Code	Female
0175-02	1/8 BSP
0175-04	1/4 BSP
0175-06	3/8 BSP
0175-08	1/2 BSP



#75EM
Extruded Male
Y-Piece

Code	Male
0175EM-04	1/4 BSPT



#75MF
M&F
Y-Piece

Code	Male	Female
0175MF-02	1/8 BSPT	1/8 BSP
0175MF-04	1/4 BSPT	1/4 BSP
0175MF-06	3/8 BSPT	3/8 BSP
0175MF-08	1/2 BSPT	1/2 BSP



#76
Breather
Vent

Code	Male
0176-02	1/8 BSPT
0176-04	1/4 BSPT
0176-06	3/8 BSPT



#80
Female
Bulkhead

Code	Female	Male
0180-02	1/8 BSP	M16x1.5
0180-04	1/4 BSP	M20x1.5
0180-06	3/8 BSP	M26x1.5
0180-08	1/2 BSP	M28x1.5
0180-12	3/4 BSP	M34x1.5
0180-16	1" BSP	M42x1.5



#81
Port
Reducer

Code	Male	Female
0181-0402	1/4 BSPP	1/8 BSP
0181-0602	3/8 BSPP	1/8 BSP
0181-0604	3/8 BSPP	1/4 BSP
0181-0804	1/2 BSPP	1/4 BSP
0181-0806	1/2 BSPP	3/8 BSP
0181-1208	3/4 BSPP	1/2 BSP
0181-1612	1" BSPP	3/4 BSP

STANDARD BRASS - BSP Screwed Fittings. (Category 1)



#85
F&F
Barrel Union

Code	Female
0185-02	1/8 BSP
0185-04	1/4 BSP
0185-06	3/8 BSP

Larger sizes available in Category 17 Plumbing Range.

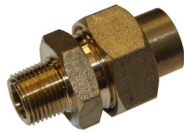

#87
M&F
Barrel Union

Code	Male	Female
0187-02	1/8 BSPT	1/8 BSP
0187-04	1/4 BSPT	1/4 BSP
0187-06	3/8 BSPT	3/8 BSP

Larger sizes available in Category 17 Plumbing Range.



Manifolds now in Category 26

STANDARD BRASS - Standard Compression Fittings. (Category 1)

TUBE: Copper, Aluminium, Bundy, Nylon (with spigot for high pressure).

PRESSURE: Medium pressure ratings around 3500kpa/500psi decreasing as tube sizes increase and depending on the medium.

TEMPERATURE: 0°C to 120°C

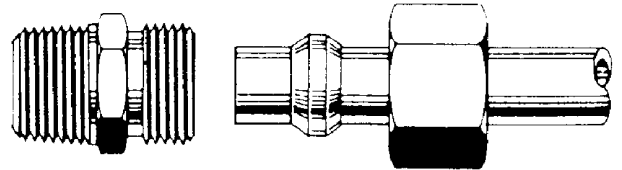

#100
Universal
Olive

Code	Tube
01100-02	1/8
01100-025	5/32
01100-03	3/16
01100-04	1/4
01100-05	5/16
01100-06	3/8
01100-08	1/2
01100-10	5/8
01100-12	3/4



#1N
Nylon
Olive

Code	Tube
0101N-04	1/4
0101N-05	5/16
0101N-06	3/8
0101N-08	1/2
0101N-10	5/8
0101N-12	3/4



#2
Tube
Nut

Code	Tube	Thread
0102-02	1/8	5/16x24
0102-03	3/16	3/8x24
0102-04	1/4	7/16x24
0102-05	5/16	1/2x24
0102-06	3/8	9/16x24
0102-08	1/2	11/16x20
0102-10	5/8	13/16x18
0102-12	3/4	1"x18



#1
Metallic Tube
Olive

Code	Tube
0101-02	1/8
0101-025	5/32
0101-03	3/16
0101-04	1/4
0101-05	5/16
0101-06	3/8
0101-07	7/16
0101-08	1/2
0101-10	5/8
0101-12	3/4



#1RR
Road Ranger
Olive

Code	Tube
0101RR-02	1/8
0101RR-025	5/32



#2SA
Self Align
Tube Nut

Code	Tube
0102SA-02	1/8
0102SA-03	3/16
0102SA-04	1/4
0102SA-05	5/16
0102SA-06	3/8



#1SA
Self Align
Olive

Code	Tube
0101SA-02	1/8
0101SA-03	3/16
0101SA-04	1/4
0101SA-05	5/16
0101SA-06	3/8

Full Range of Nylon Tube Available. Refer Category 14.
Copper Tube Also Available. Refer Category 45

STANDARD BRASS - Standard Compression Fittings. (Category 1)



#3
Male
Connector

Code	Tube	Male
0103-0202	1/8	1/8 BSPT
0103-0302	3/16	1/8 BSPT
0103-0304	3/16	1/4 BSPT
0103-0402	1/4	1/8 BSPT
0103-0404	1/4	1/4 BSPT
0103-0406	1/4	3/8 BSPT
0103-0408	1/4	1/2 BSPT
0103-0502	5/16	1/8 BSPT
0103-0504	5/16	1/4 BSPT
0103-0506	5/16	3/8 BSPT
0103-0508	5/16	1/2 BSPT
0103-0602	3/8	1/8 BSPT
0103-0604	3/8	1/4 BSPT
0103-0606	3/8	3/8 BSPT
0103-0608	3/8	1/2 BSPT
0103-0804	1/2	1/4 BSPT
0103-0806	1/2	3/8 BSPT
0103-0808	1/2	1/2 BSPT
0103-0812	1/2	3/4 BSPT
0103-1006	5/8	3/8 BSPT
0103-1008	5/8	1/2 BSPT
0103-1012	5/8	3/4 BSPT
0103-1208	3/4	1/2 BSPT
0103-1212	3/4	3/4 BSPT



#4
Double
Union

Code	Tube
0104-02	1/8
0104-03	3/16
0104-04	1/4
0104-05	5/16
0104-06	3/8
0104-08	1/2
0104-10	5/8
0104-12	3/4

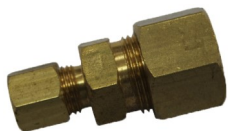

#4R
Reducing
Union

Code	Tube	Tube
0104R-0402	1/4	1/8
0104R-0403	1/4	3/16
0104R-0504	5/16	1/4
0104R-0604	3/8	1/4
0104R-0605	3/8	5/16
0104R-0804	1/2	1/4
0104R-0805	1/2	5/16
0104R-0806	1/2	3/8



#4RR
Roadranger
Double Union

Code	Tube
0104RR-02	1/8



#5
Male Elbow
Connector

Code	Tube	Male
0105-0202	1/8	1/8 BSPT
0105-0302	3/16	1/8 BSPT
0105-0304	3/16	1/4 BSPT
0105-0402	1/4	1/8 BSPT
0105-0404	1/4	1/4 BSPT
0105-0406	1/4	3/8 BSPT
0105-0408	1/4	1/2 BSPT
0105-0502	5/16	1/8 BSPT
0105-0504	5/16	1/4 BSPT
0105-0506	5/16	3/8 BSPT
0105-0508	5/16	1/2 BSPT
0105-0602	3/8	1/8 BSPT
0105-0604	3/8	1/4 BSPT
0105-0606	3/8	3/8 BSPT
0105-0608	3/8	1/2 BSPT
0105-0804	1/2	1/4 BSPT
0105-0806	1/2	3/8 BSPT
0105-0808	1/2	1/2 BSPT
0105-1006	5/8	3/8 BSPT
0105-1008	5/8	1/2 BSPT
0105-1208	3/4	1/2 BSPT
0105-1212	3/4	3/4 BSPT



#5D
45° Male Elbow
Connector

Code	Tube	Male
010545-0302	3/16	1/8 BSPT
010545-0402	1/4	1/8 BSPT
010545-0404	1/4	1/4 BSPT
010545-0502	5/16	1/8 BSPT
010545-0504	5/16	1/4 BSPT
010545-0604	3/8	1/4 BSPT
010545-0606	3/8	3/8 BSPT
010545-0806	1/2	3/8 BSPT
010545-0808	1/2	1/2 BSPT

NOTE : Compression Fittings are fitted with the #100 olive as standard. Please contact the office if there is a requirement for an alternative olive.



#10
Female
Connector

Code	Tube	Female
0110-0202	1/8	1/8 BSP
0110-0302	3/16	1/8 BSP
0110-0304	3/16	1/4 BSP
0110-0402	1/4	1/8 BSP
0110-0404	1/4	1/4 BSP
0110-0406	1/4	3/8 BSP
0110-0408	1/4	1/2 BSP
0110-0502	5/16	1/8 BSP
0110-0504	5/16	1/4 BSP
0110-0506	5/16	3/8 BSP
0110-0508	5/16	1/2 BSP
0110-0602	3/8	1/8 BSP
0110-0604	3/8	1/4 BSP
0110-0606	3/8	3/8 BSP
0110-0608	3/8	1/2 BSP
0110-0804	1/2	1/4 BSP
0110-0806	1/2	3/8 BSP
0110-0808	1/2	1/2 BSP
0110-1008	5/8	1/2 BSP
0110-1208	3/4	1/2 BSP



#11
Elbow
Union

Code	Tube
0111-02	1/8
0111-03	3/16
0111-04	1/4
0111-05	5/16
0111-06	3/8
0111-08	1/2
0111-10	5/8
0111-12	3/4



#12
Male
Branch Tee

Code	Tube	Male
0112-0202	1/8	1/8 BSPT
0112-0302	3/16	1/8 BSPT
0112-0402	1/4	1/8 BSPT
0112-0404	1/4	1/4 BSPT
0112-0502	5/16	1/8 BSPT
0112-0504	5/16	1/4 BSPT
0112-0506	5/16	3/8 BSPT
0112-0602	3/8	1/8 BSPT
0112-0604	3/8	1/4 BSPT
0112-0606	3/8	3/8 BSPT
0112-0804	1/2	1/4 BSPT
0112-0806	1/2	3/8 BSPT
0112-0808	1/2	1/2 BSPT
0112-1008	5/8	1/2 BSPT
0112-1208	3/4	1/2 BSPT

STANDARD BRASS - Standard Compression Fittings. (Category 1)



#13
Male
Run Tee

Code	Tube	Male
0113-0202	1/8	1/8 BSPT
0113-0302	3/16	1/8 BSPT
0113-0402	1/4	1/8 BSPT
0113-0404	1/4	1/4 BSPT
0113-0502	5/16	1/8 BSPT
0113-0504	5/16	1/4 BSPT
0113-0604	3/8	1/4 BSPT
0113-0606	3/8	3/8 BSPT
0113-0806	1/2	3/8 BSPT
0113-0808	1/2	1/2 BSPT



#14
Tee
Union

Code	Tube
0114-02	1/8
0114-03	3/16
0114-04	1/4
0114-05	5/16
0114-06	3/8
0114-08	1/2
0114-10	5/8
0114-12	3/4



#15
Female Elbow
Connector

Code	Tube	Female
0115-0202	1/8	1/8 BSP
0115-0302	3/16	1/8 BSP
0115-0402	1/4	1/8 BSP
0115-0404	1/4	1/4 BSP
0115-0502	5/16	1/8 BSP
0115-0504	5/16	1/4 BSP
0115-0602	3/8	1/8 BSP
0115-0604	3/8	1/4 BSP
0115-0606	3/8	3/8 BSP
0115-0804	1/2	1/4 BSP
0115-0806	1/2	3/8 BSP
0115-0808	1/2	1/2 BSP



#31
Bulkhead
Union

Code	Tube
0131-03	3/16
0131-04	1/4
0131-05	5/16
0131-06	3/8
0131-08	1/2



#31F
Female
Bulkhead Union

Code	Tube	Female
0131F-0302	3/16	1/8 BSP
0131F-0402	1/4	1/8 BSP
0131F-0404	1/4	1/4 BSP
0131F-0504	5/16	1/4 BSP
0131F-0604	3/8	1/4 BSP



#99 Insert For
250psi Flexible
Nylon Tube

Code	Tube O.D.	Tube I.D.
0199-02	1/8	0.087
0199-03	3/16	0.125
0199-04	1/4	0.169
0199-05	5/16	0.214
0199-06	3/8	0.258
0199-08	1/2	0.347
0199-10	5/8	0.495
0199-12	3/4	0.590



#99NSR Insert
For 650psi Semi-
Rigid Nylon Tube

Code	Tube O.D.	Tube I.D.
0199NSR-02	1/8	0.078
0199NSR-03	3/16	0.110
0199NSR-04	1/4	0.147
0199NSR-05	5/16	0.186
0199NSR-06	3/8	0.224
0199NSR-08	1/2	0.303

NOTE : Compression Fittings are fitted with the #100 olive as standard. Please contact the office if there is a requirement for an alternative olive.

STANDARD BRASS - S.A.E. 45° Flare Fittings. (Category 1)

TUBE: Copper, Aluminium, Bundy, Steel.
PRESSURE: For pressure ratings around 13800kpa/2000psi decreasing as tube sizes increase and depending on the medium.
TEMPERATURE: 0°C to 120°C
TYPICAL USES: LPG, Natural Gas, Oil lines.

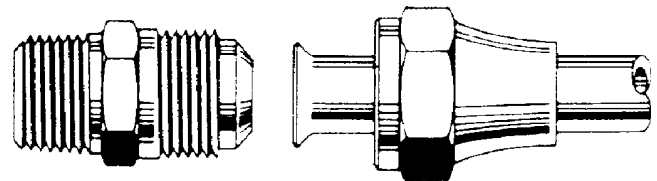

#6
Standard
Flare Nut

Code	Tube	Thread
0106-02	1/8	5/16x24
0106-03	3/16	3/8x24
0106-04	1/4	7/16x20
0106-05	5/16	1/2x20
0106-06	3/8	5/8x18
0106-08	1/2	3/4x16
0106-10	5/8	7/8x14
0106-12	3/4	1.1/16x14



#6S
Short
Flare Nut

Code	Tube
0106S-04	1/4
0106S-05	5/16
0106S-06	3/8
0106S-08	1/2



#6L
Long
Flare Nut

Code	Tube	Thread
0106L-06	3/8	5/8x18
0106L-08	1/2	3/4x16



ALSO AVAILABLE
B577 Teflon Pipe Seal
 All Purpose. High Temp. Yellow. AGA Approved
 Refer Category 24

STANDARD BRASS - S.A.E. 45° Flare Fittings. (Category 1)



#6R
Reducing
Flare Nut

Code	Tube	Tube
0106R-0302	3/16	1/8
0106R-0403	1/4	3/16
0106R-0504	5/16	1/4
0106R-0604	3/8	1/4
0106R-0605	3/8	5/16
0106R-0806	1/2	3/8



#8
Male Flare
Elbow Union

Code	Tube	Male
0108-0202	1/8	1/8 BSPT
0108-0302	3/16	1/8 BSPT
0108-0304	3/16	1/4 BSPT
0108-0402	1/4	1/8 BSPT
0108-0404	1/4	1/4 BSPT
0108-0406	1/4	3/8 BSPT
0108-0408	1/4	1/2 BSPT
0108-0502	5/16	1/8 BSPT
0108-0504	5/16	1/4 BSPT
0108-0506	5/16	3/8 BSPT
0108-0508	5/16	1/2 BSPT
0108-0602	3/8	1/8 BSPT
0108-0604	3/8	1/4 BSPT
0108-0606	3/8	3/8 BSPT
0108-0608	3/8	1/2 BSPT
0108-0802	1/2	1/8 BSPT
0108-0804	1/2	1/4 BSPT
0108-0806	1/2	3/8 BSPT
0108-0808	1/2	1/2 BSPT
0108-1006	5/8	3/8 BSPT
0108-1008	5/8	1/2 BSPT
0108-1208	3/4	1/2 BSPT
0108-1212	3/4	3/4 BSPT



#16
Female Flare
Union

Code	Tube	Female
0116-0302	3/16	1/8 BSP
0116-0304	3/16	1/4 BSP
0116-0402	1/4	1/8 BSP
0116-0404	1/4	1/4 BSP
0116-0406	1/4	3/8 BSP
0116-0502	5/16	1/8 BSP
0116-0504	5/16	1/4 BSP
0116-0506	5/16	3/8 BSP
0116-0602	3/8	1/8 BSP
0116-0604	3/8	1/4 BSP
0116-0606	3/8	3/8 BSP
0116-0608	3/8	1/2 BSP
0116-0804	1/2	1/4 BSP
0116-0806	1/2	3/8 BSP
0116-0808	1/2	1/2 BSP
0116-0812	1/2	3/4 BSP
0116-1006	5/8	3/8 BSP
0116-1008	5/8	1/2 BSP
0116-1208	3/4	1/2 BSP
0116-1212	3/4	3/4 BSP



#7
Male Flare
Union

Code	Tube	Male
0107-0202	1/8	1/8 BSPT
0107-0302	3/16	1/8 BSPT
0107-0304	3/16	1/4 BSPT
0107-0402	1/4	1/8 BSPT
0107-0404	1/4	1/4 BSPT
0107-0406	1/4	3/8 BSPT
0107-0408	1/4	1/2 BSPT
0107-0502	5/16	1/8 BSPT
0107-0504	5/16	1/4 BSPT
0107-0506	5/16	3/8 BSPT
0107-0508	5/16	1/2 BSPT
0107-0602	3/8	1/8 BSPT
0107-0604	3/8	1/4 BSPT
0107-0606	3/8	3/8 BSPT
0107-0608	3/8	1/2 BSPT
0107-0612	3/8	3/4 BSPT
0107-0802	1/2	1/8 BSPT
0107-0804	1/2	1/4 BSPT
0107-0806	1/2	3/8 BSPT
0107-0808	1/2	1/2 BSPT
0107-0812	1/2	3/4 BSPT
0107-1006	5/8	3/8 BSPT
0107-1008	5/8	1/2 BSPT
0107-1012	5/8	3/4 BSPT
0107-1016	5/8	1" BSPT
0107-1208	3/4	1/2 BSPT
0107-1212	3/4	3/4 BSPT



#8D
45° Male
Elbow Union

Code	Tube	Male
010845-0402	1/4	1/8 BSPT
010845-0404	1/4	1/4 BSPT
010845-0502	5/16	1/8 BSPT
010845-0504	5/16	1/4 BSPT
010845-0604	3/8	1/4 BSPT
010845-0606	3/8	3/8 BSPT
010845-0806	1/2	3/8 BSPT
010845-0808	1/2	1/2 BSPT
010845-1008	5/8	1/2 BSPT



#17R
Reducing
Flare Union

Code	Tube	Tube
0117R-0403	1/4	3/16
0117R-0504	5/16	1/4
0117R-0604	3/8	1/4
0117R-0605	3/8	5/16
0117R-0806	1/2	3/8



#18
Flare Union
Elbow

Code	Tube
0118-03	3/16
0118-04	1/4
0118-05	5/16
0118-06	3/8
0118-08	1/2
0118-10	5/8
0118-12	3/4



#17
Flare
Union

Code	Tube
0117-02	1/8
0117-03	3/16
0117-04	1/4
0117-05	5/16
0117-06	3/8
0117-08	1/2
0117-10	5/8
0117-12	3/4



Assembled
Flare
Fittings
available
by request

STANDARD BRASS - S.A.E. 45° Flare Fittings. (Category 1)



#19
Flare
Union Tee

Code	Tube
0119-02	1/8
0119-03	3/16
0119-04	1/4
0119-05	5/16
0119-06	3/8
0119-08	1/2
0119-10	5/8
0119-12	3/4



#19R
Reducing Flare
Union Tee

Code	Tube	Tube
0119R-0605	3/8	5/16
0119R-0806	1/2	3/8



#20
Male Flare
Branch Tee

Code	Tube	Male
0120-0302	3/16	1/8 BSPT
0120-0402	1/4	1/8 BSPT
0120-0404	1/4	1/4 BSPT
0120-0406	1/4	3/8 BSPT
0120-0502	5/16	1/8 BSPT
0120-0504	5/16	1/4 BSPT
0120-0506	5/16	3/8 BSPT
0120-0604	3/8	1/4 BSPT
0120-0606	3/8	3/8 BSPT
0120-0804	1/2	1/4 BSPT
0120-0806	1/2	3/8 BSPT
0120-0808	1/2	1/2 BSPT
0120-1008	5/8	1/2 BSPT



#36
Female Flare
Elbow Union

Code	Tube	Female
0136-0302	3/16	1/8 BSP
0136-0402	1/4	1/8 BSP
0136-0404	1/4	1/4 BSP
0136-0406	1/4	3/8 BSP
0136-0502	5/16	1/8 BSP
0136-0504	5/16	1/4 BSP
0136-0506	5/16	3/8 BSP
0136-0604	3/8	1/4 BSP
0136-0606	3/8	3/8 BSP
0136-0608	3/8	1/2 BSP
0136-0806	1/2	3/8 BSP
0136-0808	1/2	1/2 BSP
0136-1008	5/8	1/2 BSP



#54
Female Flare
x Male BSPT

Code	Tube	Male
0154-0404	1/4	1/4 BSPT
0154-0504	5/16	1/4 BSPT
0154-0604	3/8	1/4 BSPT
0154-0606	3/8	3/8 BSPT
0154-0608	3/8	1/2 BSPT
0154-0806	1/2	3/8 BSPT



#56
Flare
Cap

Code	Tube
0156-03	3/16
0156-04	1/4
0156-05	5/16
0156-06	3/8
0156-08	1/2
0156-10	5/8
0156-12	3/4



#57
M&F Flare
Adaptor

Code	Tube (M)	Tube (F)
0157-0406	1/4	3/8
0157-0504	5/16	1/4
0157-0506	5/16	3/8
0157-0604	3/8	1/4
0157-0605	3/8	5/16
0157-0608	3/8	1/2
0157-0806	1/2	3/8



#65
Flare
Plug

Code	Tube
0165-03	3/16
0165-04	1/4
0165-05	5/16
0165-06	3/8
0165-08	1/2
0165-10	5/8
0165-12	3/4



#70
Swivel
Connector

Code	Tube
0170-04	1/4
0170-05	5/16
0170-06	3/8
0170-08	1/2



Copper Tube also available in annealed coils and hard drawn lengths.

Refer Category 45

Do you need a thread sealant? We stock various types of thread tape and a full range of Bondloc thread lockers and sealants.

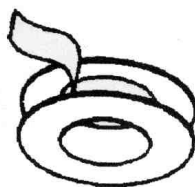

STANDARD BRASS - S.A.E. 45° Inverted Flare Fittings. (Category 1)

TUBE: Copper, Aluminium, Bundy, Steel.
PRESSURE: For pressure ratings around 13800kpa/2000psi decreasing as tube sizes increase and depending on the medium.
TEMPERATURE: 0°C to 120°C
TYPICAL USES: Automotive brake lines, Petrol/Oil lines.

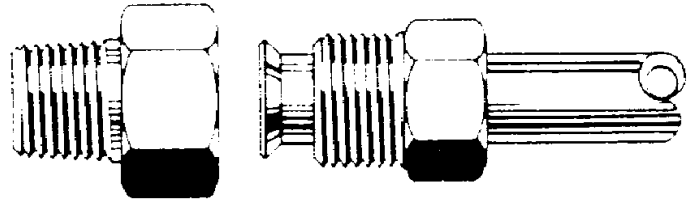

#58
Brass
Tube Nut

Code	Tube	Thread
0158-02	1/8	5/16x28
0158-03	3/16	3/8x24
0158-04	1/4	7/16x24
0158-05	5/16	1/2x20
0158-06	3/8	5/8x18
0158-08	1/2	3/4x18



#58S
Steel
Tube Nut

Code	Tube	Thread
0158S-02	1/8	5/16x28
0158S-03	3/16	3/8x24
0158S-04	1/4	7/16x24
0158S-05	5/16	1/2x20
0158S-06	3/8	5/8x18
0158S-08	1/2	3/4x18
0158S-10	5/8	7/8x18
0158S-12	3/4	1.1/16x16



#58SL
Long Steel
Tube Nut

Code	Tube	Thread
0158SL-03	3/16	3/8x24
0158SL-04	1/4	7/16x24



#60
Ford Carby
/CAV Nut

Code	Tube	Thread
0160-04	1/4	1/2x20
0160-05	5/16	1/2x20

This fitting when used with a No. 1 olive, will take 1/4 or 5/16 steel or copper tube into CAV fuel filters

Note : A larger range of Inverted Flare Fittings is available with NPT Threads (Category 2)



#59
Male
Elbow

Code	Tube	Male
0159-0202	1/8	1/8 BSPT
0159-0302	3/16	1/8 BSPT
0159-0402	1/4	1/8 BSPT
0159-0404	1/4	1/4 BSPT
0159-0502	5/16	1/8 BSPT
0159-0504	5/16	1/4 BSPT
0159-0602	3/8	1/8 BSPT
0159-0604	3/8	1/4 BSPT

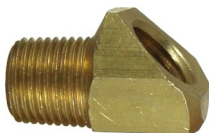

#59D
45° Male
Elbow

Code	Tube	Male
015945-0302	3/16	1/8 BSPT
015945-0402	1/4	1/8 BSPT
015945-0502	5/16	1/8 BSPT
015945-0504	5/16	1/4 BSPT
015945-0604	3/8	1/4 BSPT



#61
Inverted
Flare Tee

Code	Tube
0161-02	1/8
0161-03	3/16
0161-04	1/4
0161-05	5/16
0161-06	3/8
0161-08	1/2



#61A
Inverted Flare
Adaptor Tee

Code	Tube	Tube	Tube
0161A-030303	3/16	3/16	3/16
0161A-040403	1/4	1/4	3/16
0161A-040404	1/4	1/4	1/4



#61BR
Inverted Flare
Bracketed Tee

Code	Tube
0161BR-03	3/16



#62
Male
Adaptor

Code	Tube	Male
0162-0302	3/16	1/8 BSPT
0162-0402	1/4	1/8 BSPT
0162-0404	1/4	1/4 BSPT
0162-0502	5/16	1/8 BSPT
0162-0504	5/16	1/4 BSPT
0162-0602	3/8	1/8 BSPT
0162-0604	3/8	1/4 BSPT



#62R
Reducing Male
Adaptor

Code	Tube (M)	Tube (F)
0162R-0403	1/4	3/16
0162R-0503	5/16	3/16
0162R-0504	5/16	1/4
0162R-0605	3/8	5/16



#62W
Washer Face
Male Adaptor

Code	Tube	Male
0162W-0306	3/16	3/8 UNF
0162W-0307	3/16	7/16 UNF
0162W-0308	3/16	1/2 UNF
0162W-0406	1/4	3/8 UNF
0162W-0407	1/4	7/16 UNF
0162W-0408	1/4	1/2 UNF
0162W-0506	5/16	3/8 UNF
0162W-0508	5/16	1/2 UNF

Non Standard Automotive fittings and tube nuts with metric and imperial threads or with relieved ends are listed in Category 10 (Automotive Specials)

STANDARD BRASS - S.A.E. 45° Inverted Flare Fittings. (Category 1)



#63
Inverted
Flare Joiner

Code	Tube
0163-02	1/8
0163-03	3/16
0163-04	1/4
0163-05	5/16
0163-06	3/8
0163-08	1/2



#66
Inverted
Flare Plug

Code	Tube
0166-03	3/16
0166-04	1/4
0166-05	5/16
0166-06	3/8



#68
Inv Flare Male x
BSPT Male

Code	Tube	Male
0168-0302	3/16	1/8 BSPT
0168-0402	1/4	1/8 BSPT
0168-0504	5/16	1/4 BSPT
0168-0604	3/8	1/4 BSPT

Non Standard Automotive fittings and tube nuts with metric and imperial threads or with relieved ends are listed in Category 10 (Automotive Specials)

STANDARD BRASS - Solder-On Brass Fittings. (Category 1)



#44
Solder-On
Tail

Code	Tube
0144-03	3/16
0144-04	1/4
0144-05	5/16
0144-06	3/8
0144-08	1/2



#46
Male Solder-On
Union

Code	Tube	Male
0146-0202	1/8	1/8 BSPT
0146-0302	3/16	1/8 BSPT
0146-0402	1/4	1/8 BSPT
0146-0404	1/4	1/4 BSPT
0146-0406	1/4	3/8 BSPT
0146-0502	5/16	1/8 BSPT
0146-0504	5/16	1/4 BSPT
0146-0506	5/16	3/8 BSPT
0146-0602	3/8	1/8 BSPT
0146-0604	3/8	1/4 BSPT
0146-0606	3/8	3/8 BSPT
0146-0608	3/8	1/2 BSPT
0146-0806	1/2	3/8 BSPT
0146-0808	1/2	1/2 BSPT



#49
Solder-On
Elbow Union

Code	Tube
0149-02	1/8
0149-03	3/16
0149-04	1/4
0149-05	5/16
0149-06	3/8
0149-08	1/2



#44R
Solder-On
Reducing Tail

Code	Tube	Tube
0144R-0302	3/16	1/8
0144R-0504	5/16	1/4



#49M
Male Solder-On
Elbow Connector

Code	Tube	Male
0149M-0404	1/4	1/4 BSPT
0149M-0504	5/16	1/4 BSPT
0149M-0604	3/8	1/4 BSPT



#45
Solder-On
Nut

Code	Tube	Thread
0145SO-02	1/8	5/16x26
0145-02	3/16	1/8 BSP
0145SO-04	1/4	7/16x20
0145-04	5/16	1/4 BSP
0145-06	3/8	3/8 BSP
0145-08	1/2	1/2 BSP



#47
Solder-On
Joiner

Code	Tube	Tube
0147-02	1/8	1/8
0147-03	3/16	3/16
0147-04	1/4	1/4
0147-05	5/16	5/16
0147-06	3/8	3/8
0147R-0605	3/8	5/16
0147-08	1/2	1/2



#50
Solder-On
Tee Union

Code	Tube
0150-02	1/8
0150-03	3/16
0150-04	1/4
0150-05	5/16
0150-06	3/8
0150-08	1/2



#46F
Female Solder-On
Union

Code	Tube	Female
0146F-0404	1/4	1/4 BSP



**Air
Silencers
now in
Category 26**

STANDARD BRASS - NPT Screwed Fittings. (Category 2)

PRESSURE: Medium pressure ratings around 3500kpa/500psi decreasing as sizes increase and depending on the medium.
TEMPERATURE: 0°C to 120°C
TYPICAL USES: Mostly to join or adapt other fittings or pipe.

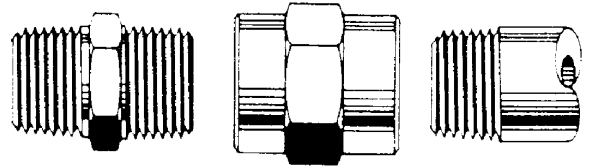

NPT and NPSM THREAD CHART

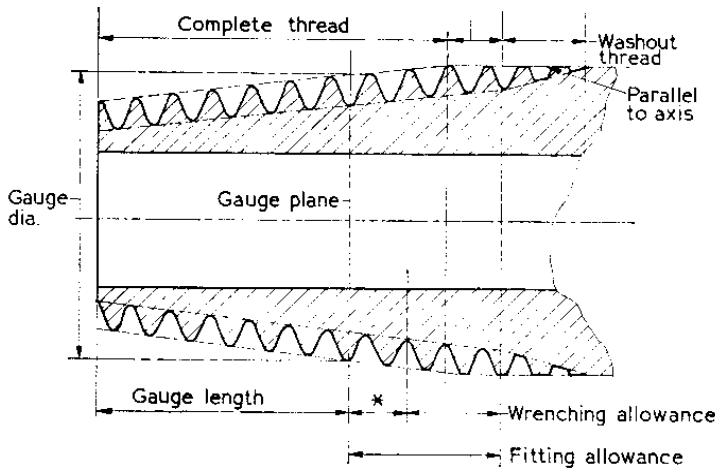

Size	Pitch TPI	Male Thread OD		Female Thread ID	
		mm	inch	mm	inch
1/16	27	7.9	0.31	6.1	0.24
1/8	27	10.2	0.40	8.4	0.33
1/4	18	13.7	0.54	11.2	0.44
3/8	18	17.0	0.67	14.7	0.58
1/2	14	21.1	0.83	17.8	0.70
3/4	14	26.4	1.04	23.4	0.92
1"	11.5	33.3	1.31	29.5	1.16
1.1/4	11.5	41.9	1.65	38.1	1.50
1.1/2	11.5	48.0	1.89	43.9	1.73
2"	11.5	59.9	2.36	56.4	2.22
2.1/2	8	72.4	2.85	69.1	2.72
3"	8	88.1	3.47	84.8	3.34



#24
Reducing Bush

Code	Male	Female
02N24-0402	1/4 NPT	1/8 NPT
02N24-0602	3/8 NPT	1/8 NPT
02N24-0604	3/8 NPT	1/4 NPT
02N24-0802	1/2 NPT	1/8 NPT
02N24-0804	1/2 NPT	1/4 NPT
02N24-0806	1/2 NPT	3/8 NPT
02N24-1202	3/4 NPT	1/8 NPT
02N24-1204	3/4 NPT	1/4 NPT
02N24-1206	3/4 NPT	3/8 NPT
02N24-1208	3/4 NPT	1/2 NPT
02N24-1608	1" NPT	1/2 NPT
02N24-1612	1" NPT	3/4 NPT



#25D
45° M&F Elbow

Code	Male	Female
02N2545-02	1/8 NPT	1/8 NPT
02N2545-04	1/4 NPT	1/4 NPT
02N2545-06	3/8 NPT	3/8 NPT
02N2545-08	1/2 NPT	1/2 NPT
02N2545-12	3/4 NPT	3/4 NPT



#27
Hex Nipple

Code	Male
02N27-02	1/8 NPT
02N27-04	1/4 NPT
02N27-06	3/8 NPT
02N27-08	1/2 NPT
02N27-12	3/4 NPT
02N27-16	1" NPT



#26
Hex Socket

Code	Female
02N26-02	1/8 NPT
02N26-04	1/4 NPT
02N26-06	3/8 NPT
02N26-08	1/2 NPT
02N26-12	3/4 NPT



#28
Long Hex Nipple

Code	Male	Length
02N28-0224	1/8 NPT	1.1/2"



#25EL
M&F Elbow

Code	Male	Female
02N25EL-02	1/8 NPT	1/8 NPT
02N25R-0204	1/8 NPT	1/4 NPT
02N25R-0402	1/4 NPT	1/8 NPT
02N25EL-04	1/4 NPT	1/4 NPT
02N25EL-06	3/8 NPT	3/8 NPT
02N25EL-08	1/2 NPT	1/2 NPT
02N25EL-12	3/4 NPT	3/4 NPT



#28R
Long Round Nipple

Code	Male	Length
02N28R-0224	1/8 NPT	1.1/2
02N28R-0232	1/8 NPT	2"
02N28R-0424	1/4 NPT	1.1/2
02N28R-0432	1/4 NPT	2"
02N28R-0632	3/8 NPT	2"
02N28R-0640	3/8 NPT	2.1/2

NPT to BSP Adaptors also Available.
Refer Category 3

STANDARD BRASS - NPT Screwed Fittings. (Category 2)



#29
Reducing
Socket

Code	Female	Female
02N29-0402	1/4 NPT	1/8 NPT
02N29-0602	3/8 NPT	1/8 NPT
02N29-0604	3/8 NPT	1/4 NPT
02N29-0806	1/2 NPT	3/8 NPT



#33
Hex
Cap

Code	Female
02N33-02	1/8 NPT
02N33-04	1/4 NPT
02N33-06	3/8 NPT



#34
Female
Elbow

Code	Female
02N34-02	1/8 NPT
02N34-04	1/4 NPT
02N34-06	3/8 NPT
02N34-08	1/2 NPT
02N34-12	3/4 NPT



#35
Female
Tee

Code	Female
02N35-02	1/8 NPT
02N35-04	1/4 NPT
02N35-06	3/8 NPT
02N35-08	1/2 NPT
02N35-12	3/4 NPT



#35B
Male Branch
Tee

Code	Male	Female
02N35B-02	1/8 NPT	1/8 NPT
02N35B-04	1/4 NPT	1/4 NPT
02N35B-06	3/8 NPT	3/8 NPT
02N35B-08	1/2 NPT	1/2 NPT



#35R
Male Run
Tee

Code	Male	Female
02N35R-02	1/8 NPT	1/8 NPT
02N35R-04	1/4 NPT	1/4 NPT
02N35R-06	3/8 NPT	3/8 NPT
02N35R-08	1/2 NPT	1/2 NPT
02N35R-12	3/4 NPT	3/4 NPT



#37
Female
Cross

Code	Female
02N37-02	1/8 NPT
02N37-04	1/4 NPT
02N37-06	3/8 NPT
02N37-08	1/2 NPT



#48
Male
Elbow

Code	Male	Male
02N48-02	1/8 NPT	1/8 NPT
02N48R-0402	1/4 NPT	1/8 NPT
02N48-04	1/4 NPT	1/4 NPT



#64
Hollow
Hex Plug

Code	Male
02N64-01	1/16 NPT
02N64-02	1/8 NPT
02N64-04	1/4 NPT
02N64-06	3/8 NPT
02N64-08	1/2 NPT
02N64-12	3/4 NPT
02N64-16	1" NPT



#64IH
Internal
Hex Plug

Code	Male
02N64IH-02	1/8 NPT
02N64IH-04	1/4 NPT
02N64IH-06	3/8 NPT
02N64IH-08	1/2 NPT



#64SH
Square
Head Plug

Code	Male
02N64SH-02	1/8 NPT
02N64SH-04	1/4 NPT
02N64SH-06	3/8 NPT
02N64SH-08	1/2 NPT



#64SL
Slotted
Head Plug

Code	Male
02N64SL-02	1/8 NPT
02N64SL-04	1/4 NPT



#72
M&F
Adaptor

Code	Female	Male
02N72-0202	1/8 NPT	1/8 NPT
02N72-0402	1/4 NPT	1/8 NPT
02N72-0404	1/4 NPT	1/4 NPT
02N72-0604	3/8 NPT	1/4 NPT
02N72-0606	3/8 NPT	3/8 NPT
02N72-0804	1/2 NPT	1/4 NPT
02N72-0806	1/2 NPT	3/8 NPT
02N72-0808	1/2 NPT	1/2 NPT
02N72-1206	3/4 NPT	3/8 NPT
02N72-1208	3/4 NPT	1/2 NPT



#72L
Long M&F
Adaptor

Code	Thread	Length
02N72L-0224	1/8 NPT	1.1/2



#73
Reducing
Nipple

Code	Male	Male
02N73-0402	1/4 NPT	1/8 NPT
02N73-0602	3/8 NPT	1/8 NPT
02N73-0604	3/8 NPT	1/4 NPT
02N73-0804	1/2 NPT	1/4 NPT
02N73-0806	1/2 NPT	3/8 NPT
02N73-1204	3/4 NPT	1/4 NPT
02N73-1208	3/4 NPT	1/2 NPT

STANDARD BRASS - NPT Screwed Fittings. (Category 2)



#74
Hex
Locknut

Code	Female
02N74-02	1/8 NPS
02N74-04	1/4 NPS

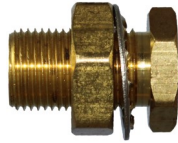

Code	Female	Male	L	W
02N80-04	1/4 NPT	3/4x16 UNF	1.25	1.50
02N80-06	3/8 NPT	1"x14 UNF	1.00	1.25
02N80-08	1/2 NPT	1.1/8x14 UNF	1.25	1.50

#80
Female
Bulkhead

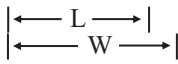

#76
Breather
Vent

Code	Male
02N76-02	1/8 NPT

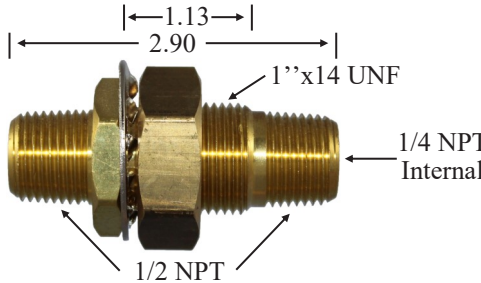

Code : 02N80MF-080804

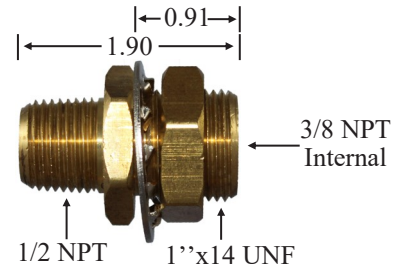

Code : 02N80MF-0806

NPT to BSP Adaptors also Available.
Refer Category 3

STANDARD BRASS - Std Compression Fittings - NPT. (Category 2)

TUBE: Copper, Aluminium, Bundy, Nylon (with spigot for high pressure).

PRESSURE: Medium pressure ratings around 3500kpa/500psi decreasing as tube sizes increase and depending on the medium.

TEMPERATURE: 0°C to 120°C

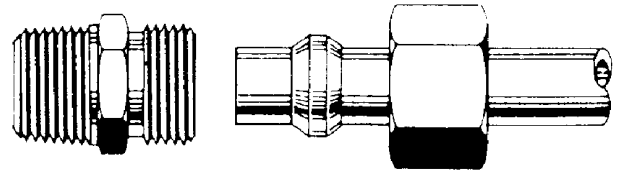

For All Olives and Tube Nuts.
Refer Category 1



#3
Male
Connector

Code	Tube	Male
02N03-0201	1/8	1/16 NPT
02N03-0202	1/8	1/8 NPT
02N03-0302	3/16	1/8 NPT
02N03-0402	1/4	1/8 NPT
02N03-0404	1/4	1/4 NPT
02N03-0502	5/16	1/8 NPT
02N03-0504	5/16	1/4 NPT
02N03-0602	3/8	1/8 NPT
02N03-0604	3/8	1/4 NPT
02N03-0606	3/8	3/8 NPT
02N03-0608	3/8	1/2 NPT
02N03-0804	1/2	1/4 NPT
02N03-0806	1/2	3/8 NPT
02N03-0808	1/2	1/2 NPT



#3RR
Male Connector
with
Roadranger
Olive

Code	Tube	Male
02N03RR-0201	1/8	1/16 NPT
02N03RR-0202	1/8	1/8 NPT



#4
Double
Union

Refer Category 1



#5D
45° Male Elbow
Connector

Code	Tube	Male
02N0545-0602	3/8	1/8 NPT

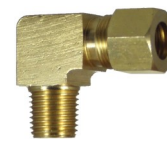

#5
Male Elbow
Connector

Code	Tube	Male
02N05-0202	1/8	1/8 NPT
02N05-0302	3/16	1/8 NPT
02N05-0402	1/4	1/8 NPT
02N05-0404	1/4	1/4 NPT
02N05-0406	1/4	3/8 NPT
02N05-0502	5/16	1/8 NPT
02N05-0504	5/16	1/4 NPT
02N05-0602	3/8	1/8 NPT
02N05-0604	3/8	1/4 NPT
02N05-0606	3/8	3/8 NPT
02N05-0806	1/2	3/8 NPT
02N05-1006	5/8	3/8 NPT

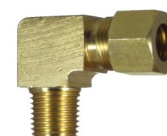

#5RR
Male Elbow with
Roadranger Olive

Code	Tube	Male
02N05RR-0202	1/8	1/8 NPT

NOTE : Compression Fittings are fitted with the #100 olive as standard. Please contact the office if there is a requirement for an alternative olive.

STANDARD BRASS - Std Compression Fittings - NPT. (Category 2)

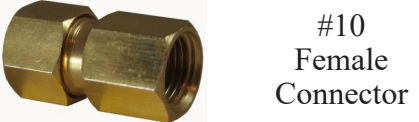

#10
Female
Connector

Code	Tube	Female
02N10-0202	1/8	1/8 NPT
02N10-0302	3/16	1/8 NPT
02N10-0402	1/4	1/8 NPT
02N10-0404	1/4	1/4 NPT
02N10-0502	5/16	1/8 NPT
02N10-0504	5/16	1/4 NPT
02N10-0604	3/8	1/4 NPT
02N10-0806	1/2	3/8 NPT
02N10-0808	1/2	1/2 NPT



#12
Male
Branch Tee

Code	Tube	Male
02N12-0302	3/16	1/8 NPT
02N12-0402	1/4	1/8 NPT
02N12-0404	1/4	1/4 NPT
02N12-0502	5/16	1/8 NPT
02N12-0604	3/8	1/4 NPT
02N12-0806	1/2	3/8 NPT



Refer
Category 1

#11
Elbow
Union



#13
Male
Run Tee

Code	Tube	Male
02N13-0402	1/4	1/8 NPT
02N13-0604	3/8	1/4 NPT
02N13-0806	1/2	3/8 NPT



Refer Category 1

#14
Tee
Union



#15
Female Elbow
Connector

Code	Tube	Female
02N15-0202	1/8	1/8 NPT
02N15-0302	3/16	1/8 NPT
02N15-0402	1/4	1/8 NPT
02N15-0502	5/16	1/8 NPT
02N15-0604	3/8	1/4 NPT
02N15-0806	1/2	3/8 NPT



Refer Category 1

#31
Bulkhead
Union

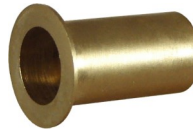

Refer Category 1

#99
Tube
Insert

STANDARD BRASS - S.A.E. 45° Flare Fittings - NPT. (Category 2)

TUBE: Copper, Aluminium, Bundy, Steel.
PRESSURE: For pressure ratings ~ 13800kpa/2000psi decreasing as tube sizes increase and depending on the medium.
TEMPERATURE: 0°C to 120°C
TYPICAL USES: LPG, Natural Gas, Oil lines.

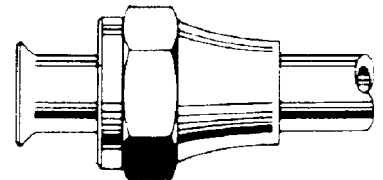
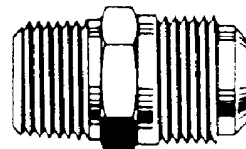

#7
Male Flare
Union

Code	Tube	Male
02N07-0202	1/8	1/8 NPT
02N07-0301	3/16	1/16 NPT
02N07-0302	3/16	1/8 NPT
02N07-0402	1/4	1/8 NPT
02N07-0404	1/4	1/4 NPT



#7 (cont)
Male Flare
Union

Code	Tube	Male
02N07-0502	5/16	1/8 NPT
02N07-0504	5/16	1/4 NPT
02N07-0506	5/16	3/8 NPT
02N07-0602	3/8	1/8 NPT
02N07-0604	3/8	1/4 NPT
02N07-0606	3/8	3/8 NPT
02N07-0608	3/8	1/2 NPT
02N07-0804	1/2	1/4 NPT
02N07-0806	1/2	3/8 NPT
02N07-1006	5/8	3/8 NPT
02N07-1212	3/4	3/4 NPT



#8
Male Flare
Elbow Union

Code	Tube	Male
02N08-0202	1/8	1/8 NPT
02N08-0302	3/16	1/8 NPT
02N08-0402	1/4	1/8 NPT
02N08-0404	1/4	1/4 NPT
02N08-0502	5/16	1/8 NPT
02N08-0504	5/16	1/4 NPT
02N08-0602	3/8	1/8 NPT
02N08-0604	3/8	1/4 NPT
02N08-0606	3/8	3/8 NPT
02N08-0608	3/8	1/2 NPT
02N08-0806	1/2	3/8 NPT
02N08-1006	5/8	3/8 NPT

STANDARD BRASS - S.A.E. 45° Flare Fittings - NPT. (Category 2)



#8D
45° Male
Elbow Union

Code	Tube	Male
02N0845-0402	1/4	1/8 NPT
02N0845-0404	1/4	1/4 NPT
02N0845-0502	5/16	1/8 NPT
02N0845-0604	3/8	1/4 NPT
02N0845-0606	3/8	3/8 NPT
02N0845-0806	1/2	3/8 NPT
02N0845-1006	5/8	3/8 NPT



#16
Female Flare
Union

Code	Tube	Female
02N16-0402	1/4	1/8 NPT
02N16-0404	1/4	1/4 NPT
02N16-0406	1/4	3/8 NPT
02N16-0502	5/16	1/8 NPT
02N16-0504	5/16	1/4 NPT
02N16-0506	5/16	3/8 NPT
02N16-0602	3/8	1/8 NPT
02N16-0604	3/8	1/4 NPT
02N16-0606	3/8	3/8 NPT
02N16-0608	3/8	1/2 NPT
02N16-0806	1/2	3/8 NPT
02N16-0808	1/2	1/2 NPT



#17
Flare
Union

Refer Category 1



#18
Flare Union
Elbow

Refer Category 1



#19
Flare
Union Tee

Refer Category 1



#20
Male Flare
Branch Tee

Code	Tube	Male
02N20-0402	1/4	1/8 NPT
02N20-0502	5/16	1/8 NPT
02N20-0604	3/8	1/4 NPT
02N20-0606	3/8	3/8 NPT



#56
Flare
Cap

Refer Category 1



#36
Female Flare
Elbow Union

Code	Tube	Female
02N36-0402	1/4	1/8 NPT
02N36-0604	3/8	1/4 NPT
02N36-0606	3/8	3/8 NPT
02N36-0806	1/2	3/8 NPT
02N36-0808	1/2	1/2 NPT



#57
M&F Flare
Adaptor

Refer Category 1



#65
Flare
Plug

Refer Category 1



#70
Swivel
Connector

Refer Category 1



We also have a large range of Imperial Flaring, Bending and Cutting Tools. Refer Category 65

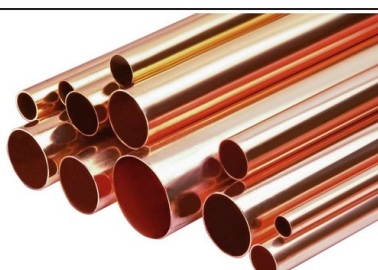
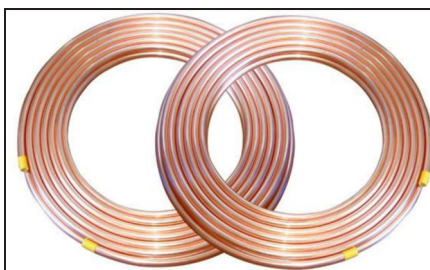

Copper Tube also available in annealed coils and hard drawn lengths.

Refer Category 45

STANDARD BRASS - SAE 45° Inv Flare Fittings - NPT. (Category 2)

TUBE: Copper, Aluminium, Bundy, Steel.
PRESSURE: For pressure ratings around 13800kpa/2000psi decreasing as tube sizes increase and depending on the medium.
TEMPERATURE: 0°C to 120°C
TYPICAL USES: Automotive brake lines, Petrol/Oil lines.

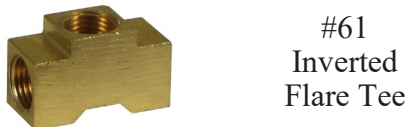
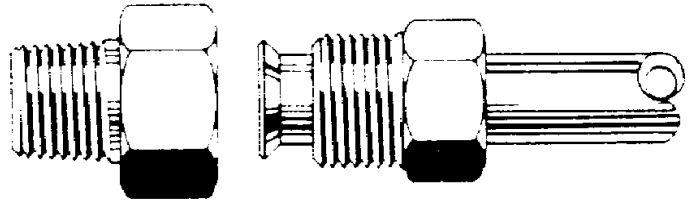

Refer Category 1

Code	Tube	Male
02N62-0202	1/8	1/8 NPT
02N62-0302	3/16	1/8 NPT
02N62-0402	1/4	1/8 NPT
02N62-0404	1/4	1/4 NPT
02N62-0502	5/16	1/8 NPT
02N62-0504	5/16	1/4 NPT
02N62-0602	3/8	1/8 NPT
02N62-0604	3/8	1/4 NPT
02N62-0606	3/8	3/8 NPT
02N62-0804	1/2	1/4 NPT
02N62-0806	1/2	3/8 NPT
02N62-0808	1/2	1/2 NPT
02N62-1008	5/8	1/2 NPT

Code	Tube	Male
02N59-0202	1/8	1/8 NPT
02N59-0302	3/16	1/8 NPT
02N59-0402	1/4	1/8 NPT
02N59-0404	1/4	1/4 NPT
02N59-0502	5/16	1/8 NPT
02N59-0504	5/16	1/4 NPT
02N59-0602	3/8	1/8 NPT
02N59-0604	3/8	1/4 NPT
02N59-0606	3/8	3/8 NPT
02N59-0804	1/2	1/4 NPT
02N59-0806	1/2	3/8 NPT
02N59-0808	1/2	1/2 NPT



Refer Category 1



Refer Category 1



Refer Category 1



Code	Tube	Male
02N61M-0404	1/4	1/4 NPT



Refer Category 1

Code	Tube	Male
02N5945-0302	3/16	1/8 NPT
02N5945-0402	1/4	1/8 NPT
02N5945-0502	5/16	1/8 NPT
02N5945-0504	5/16	1/4 NPT
02N5945-0604	3/8	1/4 NPT
02N5945-0806	1/2	3/8 NPT
02N5945-1008	5/8	1/2 NPT



Refer Category 1



Refer Category 1

Non Standard Automotive fittings and tube nuts with metric and imperial threads or with relieved ends are listed in Category 10 (Automotive Specials)

Hose Tails with Inverted Flare Male Threads are listed in Category 6

Do you need a thread sealant? We stock various types of thread tape and a full range of Bondloc thread lockers and sealants.



STANDARD BRASS - Screwed Fittings - Other Threads. (Category 3)

PRESSURE: Medium pressure ratings around 3500kpa/500psi decreasing as sizes increase and depending on the medium.

TEMPERATURE: 0°C to 120°C

TYPICAL USES: Mostly to join or adapt other fittings or pipe.

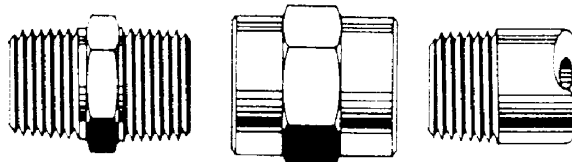

#24
Reducing
Bush

Code	Male	Female
0324-02M05B	1/8 BSPT	M5x0.8
0324-04N02	1/4 BSPT	1/8 NPT
0324-04SH	1/4 BSPT	Schrader
0324-06M10C	3/8 BSPT	M10x1
0324-06N02	3/8 BSPT	1/8 NPT
0324-06N04	3/8 BSPT	1/4 NPT
0324-08M16E	1/2 BSPT	M16x1.5
0324-08N02	1/2 BSPT	1/8 NPT
0324-12N04	3/4 BSPT	1/4 NPT
0324-M16E04	M16x1.5	1/4 BSP
0324-M16EN02	M16x1.5	1/8 NPT
0324-M22E04	M22x1.5	1/4 BSP
0324-M22E06	M22x1.5	3/8 BSP
0324-M22EM16E	M22x1.5	M16x1.5
0324-M22EN04	M22x1.5	1/4 NPT
0324-M22EN06	M22x1.5	3/8 NPT
0324-M22EU10	M22x1.5	5/8 UNF
0324-M25EM20E	M25x1.5	M20x1.5



#24A
Reducing Bush
c/w O-Ring

Code	Male	Female
0324-M14E02A	M14x1.5	1/8 BSP
0324-M14EN02A	M14x1.5	1/8 NPT
0324-M16E02A	M16x1.5	1/8 BSP
0324-M16E04A	M16x1.5	1/4 BSP
0324-M16EN02A	M16x1.5	1/8 NPT
0324-M18E04A	M18x1.5	1/4 BSP
0324-M20E04A	M20x1.5	1/4 BSP
0324-M22E04A	M22x1.5	1/4 BSP
0324-M22E06A	M22x1.5	3/8 BSP
0324-M22EM16EA	M22x1.5	M16x1.5
0324-M22EN04A	M22x1.5	1/4 NPT
0324-M22EN06A	M22x1.5	3/8 NPT
0324-M22EU10A	M22x1.5	5/8 UNF
0324-M24E06A	M24x1.5	3/8 BSP



#25EL
M&F
Elbow

Code	Male	Female
0325-04N04	1/4 BSPT	1/4 NPT
0325-02M06C	M6x1	1/8 BSP



#25D
45° M&F
Elbow

Code	Male	Female
0325D-04M06	M6x1	1/4 BSP
0325D-04U04	1/4 UNF	1/4 BSP



#26
Hex
Socket

Code	Female
0326-M12E	M12x1.5
0326-M14E	M14x1.5
0326-M16E	M16x1.5
0326-M18E	M18x1.5
0326-M20E	M20x1.5
0326-M22E	M22x1.5
0326-M24E	M24x1.5



#27
Hex
Nipple

Code	Male	Male
0327-02N02	1/8 BSPT	1/8 NPT
0327-04N04	1/4 BSPT	1/4 NPT
0327-06N06	3/8 BSPT	3/8 NPT
0327-08N08	1/2 BSPT	1/2 NPT
0327-12N12	3/4 BSPT	3/4 NPT
0327-16N16	1" BSPT	1" NPT
0327-20N20	1.1/4 BSPT	1.1/4 NPT
0327-24N24	1.1/2 BSPT	1.1/2 NPT
0327-32N32	2" BSPT	2" NPT
0327-M05B	M5x0.8	M5x0.8



#29
Reducing
Socket

Code	Female	Female
0329-M12E04	M12x1.5	1/4 BSP
0329-M14E04	M14x1.5	1/4 BSP
0329-M16E04	M16x1.5	1/4 BSP
0329-M16EN04	M16x1.5	1/4 NPT
0329-M18E06	M18x1.5	3/8 BSP
0329-M20E06	M20x1.5	3/8 BSP
0329-M22E06	M22x1.5	3/8 BSP



#33
Hex
Cap

Code	Female
0333-M22E	M22x1.5



#64
Hex
Plug

Code	Male
0364-M05B	M5x0.8
0364-M08C	M8x1
0364-M10C	M10x1
0364-M12D	M12x1.25

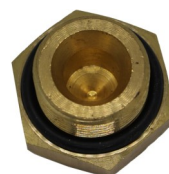

#64A
Hex Plug
c/w O-Ring

Code	Male
0364-M12CA	M12x1
0364-M12EA	M12x1.5
0364-M14EA	M14x1.5
0364-M16EA	M16x1.5
0364-M18EA	M18x1.5
0364-M20EA	M20x1.5
0364-M22EA	M22x1.5
0364-M24EA	M24x1.5

The range of metric to BSP and NPT adaptors is constantly being expanded.

Please contact the sales office if you have a requirement that is not currently in the catalogue.

STANDARD BRASS - Screwed Fittings - Other Threads. (Category 3)



#72
M&F
Adaptor

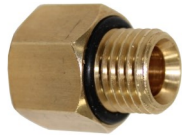

#72A
M&F Adaptor
c/w O-Ring

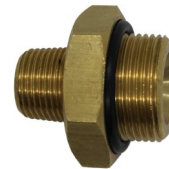

#73A
Reducing
Nipple
c/w O-Ring

Code	Female	Male
0372-02M05B	1/8 BSP	M5x0.8
0372-02M06C	1/8 BSP	M6x1
0372-02M08C	1/8 BSP	M8x1
0372-02M08D	1/8 BSP	M8x1.25
0372-02M10C	1/8 BSP	M10x1
0372-02N02	1/8 BSP	1/8 NPT
0372-02U03	1/8 BSP	3/16 UNF
0372-02U04	1/8 BSP	1/4 UNF
0372-02U05	1/8 BSP	5/16 UNF
0372-04M06C	1/4 BSP	M6x1
0372-04M08C	1/4 BSP	M8x1
0372-04M08D	1/4 BSP	M8x1.25
0372-04M10C	1/4 BSP	M10x1
0372-04M10D	1/4 BSP	M10x1.25
0372-04M12C	1/4 BSP	M12x1
0372-04M12D	1/4 BSP	M12x1.25
0372-04M12E	1/4 BSP	M12x1.5
0372-04N02	1/4 BSP	1/8 NPT
0372-04N04	1/4 BSP	1/4 NPT
0372-04U04	1/4 BSP	1/4 UNF
0372-06M18E	3/8 BSP	M18x1.5
0372-06N06	3/8 BSP	3/8 NPT
0372-08M16E	1/2 BSP	M16x1.5
0372-08M18E	1/2 BSP	M18x1.5
0372-08M22E	1/2 BSP	M22x1.5
0372-16N16	1" BSP	1" NPT
0372-20N20	1.1/4 BSP	1.1/4 NPT
0372-24N24	1.1/2 BSP	1.1/2 NPT
0372-32N32	2" BSP	2" NPT
0372-M10C02	M10x1	1/8 BSPT
0372-M10E02	M10x1.5	1/8 BSPT
0372-M12E04	M12x1.5	1/4 BSPT
0372-M14E04	M14x1.5	1/4 BSPT
0372-M14EM10C	M14x1.5	M10x1
0372-M16E04	M16x1.5	1/4 BSPT
0372-M16E06	M16x1.5	3/8 BSPT
0372-M16EM14E	M16x1.5	M14x1.5
0372-M16EN06	M16x1.5	3/8 NPT
0372-M18E06	M18x1.5	3/8 BSPT
0372-M22E06	M22x1.5	3/8 BSPT
0372-M22EM16E	M22x1.5	M16x1.5
0372-M22EN12	M22x1.5	3/4 NPT
0372-N0202	1/8 NPT	1/8 BSPT
0372-N02M10C	1/8 NPT	M10x1
0372-N0402	1/4 NPT	1/8 BSPT
0372-N0404	1/4 NPT	1/4 BSPT
0372-N04M12E	1/4 NPT	M12x1.5
0372-N0604	3/8 NPT	1/4 BSPT
0372-N0606	3/8 NPT	3/8 BSPT
0372-N0808	1/2 NPT	1/2 BSPT
0372-N1212	3/4 NPT	3/4 BSPT

Code	Female	Male
0372-02M12EA	1/8 BSP	M12x1.5
0372-04M10EA	1/4 BSP	M10x1.5
0372-04M14EA	1/4 BSP	M14x1.5
0372-06M16EA	3/8 BSP	M16x1.5
0372-08M16EA	1/2 BSP	M16x1.5
0372-08M22EA	1/2 BSP	M22x1.5
0372-M22EM16EA	M22x1.5	M16x1.5
0372-N04M12EA	1/4 NPT	M12x1.5
0372-N04M16EA	1/4 NPT	M16x1.5
0372-N06M16EA	3/8 NPT	M16x1.5



#73
Reducing
Nipple

Code	Male	Male
0373-02M10C	1/8 BSPT	M10x1
0373-04M10C	1/4 BSPT	M10x1
0373-04N02	1/4 BSPT	1/8 NPT
0373-12M22E	3/4 BSPT	M22x1.5
0373-16N12	1" BSPT	3/4 NPT
0373-M20E06	M20x1.5	3/8 BSPT
0373-M22E06	M22x1.5	3/8 BSPT
0373-N0402	1/4 NPT	1/8 BSPT
0373-N0602	3/8 NPT	1/8 BSPT

The range of metric to BSP and NPT adaptors is constantly being expanded.

Please contact the sales office if you have a requirement that is not currently in the catalogue.



Code	Male	Male
0373-12M22EA	3/4 BSPT	M22x1.5
0373-M12E02A	M12x1.5	1/8 BSPT
0373-M12E04A	M12x1.5	1/4 BSPT
0373-M14E04A	M14x1.5	1/4 BSPT
0373-M16E04A	M16x1.5	1/4 BSPT
0373-M18E04A	M18x1.5	1/4 BSPT
0373-M20E04A	M20x1.5	1/4 BSPT
0373-M22E06A	M22x1.5	3/8 BSPT
0373-M22E08A	M22x1.5	1/2 BSPT
0373-M24E06A	M24x1.5	3/8 BSPT



#74
Hex
Locknut

Code	Female
0374-M16E	M16x1.5
0374-M20E	M20x1.5
0374-M26E	M26x1.5
0374-M28E	M28x1.5

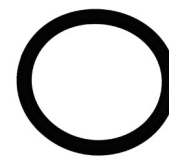

#OR
O-Ring

Code	Thread
03OR-M16	M16
03OR-M22	M22



#TW
Thrust
Washer

Code	Thread
03TW-M16	M16
03TW-M22	M22

More UNF and Metric Threaded fittings can be found in the central lubrication section.

Refer Category 56

STANDARD BRASS - Std Comp Fittings - Other Threads. (Category 3)



#3
Male
Connector



#5
Male Elbow
Connector

NOTE : Compression Fittings are fitted with the #100 olive as standard. Please contact the office if there is a requirement for an alternative olive.

Code	Tube	Male
0303-03M06C	3/16	M6x1
0303-03M10C	3/16	M10x1
0303-03M12D	3/16	M12x1.25
0303-03M12E	3/16	M12x1.5
0303-03U04	3/16	1/4 UNF
0303-04M06C	1/4	M6x1
0303-04M08C	1/4	M8x1
0303-04M12E	1/4	M12x1.5
0303-04U04	1/4	1/4 UNF
0303-04W05	1/4	5/16 BSW

Code	Tube	Thread
0305-03M06C	3/16	M6x1
0305-03U04	3/16	1/4 UNF
0305-04M06C	1/4	M6x1
0305-04U04	1/4	1/4 UNF

Refer to Category 1 for all Tube to Tube or Tube to BSP Compression Fittings.
Refer to Category 2 for all Tube to NPT Compression Fittings.

STANDARD BRASS - Brass JIC Fittings. (Category 3)



#7
Male JIC
Flare Union



#8
Male JIC
Elbow Union



#56
JIC Flare
Cap

Code	JIC	Male
0307-J0704	7/16	1/4 BSPT
0307-J0904	9/16	1/4 BSPT
0307-J0906	9/16	3/8 BSPT

Code	JIC	Male
0308-J0904	9/16	1/4 BSPT
0308-J0906	9/16	3/8 BSPT
0308-J0908	9/16	1/2 BSPT

Code	JIC
0356-J07	7/16

See Category 1 for all Tube to Tube or Tube to BSP Fittings.
See Category 2 for NPT Fittings.

METRIC THREAD IDENTIFICATION CHART

JIC THREAD CHART

Thread	Pitch		Male thread OD		Female thread ID	
	mm	tpi	mm	inch	mm	inch
M5 x 0.8	0.80	31.75	4.83	0.190	3.96	0.156
M6 x 0.75	0.75	33.87	5.84	0.230	5.03	0.198
M6 x 1	1.00	25.40	5.78	0.228	4.70	0.185
M8 x 1	1.00	25.40	7.78	0.306	6.70	0.264
M8 x 1.25	1.25	20.32	7.73	0.304	6.38	0.251
M10 x 1	1.00	25.40	9.78	0.385	8.70	0.343
M10 x 1.25	1.25	20.32	9.73	0.383	8.38	0.330
M10 x 1.5	1.50	16.93	9.68	0.381	8.05	0.317
M12 x 1	1.00	25.40	11.78	0.464	10.70	0.421
M12 x 1.25	1.25	20.32	11.73	0.462	10.38	0.409
M12 x 1.5	1.50	16.93	11.68	0.460	10.05	0.396
M14 x 1.5	1.50	16.93	13.68	0.539	12.05	0.474
M16 x 1.5	1.50	16.93	15.68	0.617	14.05	0.553
M18 x 1.5	1.50	16.93	17.68	0.696	16.05	0.632
M20 x 1.5	1.50	16.93	19.68	0.775	18.05	0.711
M22 x 1.5	1.50	16.93	21.68	0.854	20.05	0.789
M24 x 1.5	1.50	16.93	23.68	0.932	22.05	0.868
M25 x 1.5	1.50	16.93	24.68	0.972	23.05	0.907
M26 x 1.5	1.50	16.93	25.68	1.011	24.05	0.947
M28 x 1.5	1.50	16.93	27.68	1.090	26.05	1.026

Dash Size	Tube OD	Thread
-2	1/8	5/16 x 24
-3	3/16	3/8 x 24
-4	1/4	7/16 x 20
-5	5/16	1/2 x 20
-6	3/8	9/16 x 18
-8	1/2	3/4 x 16
-10	5/8	7/8 x 14
-12	3/4	1.1/16 x 12
-14	7/8	1.3/16 x 12
-16	1"	1.5/16 x 12
-20	1.1/4	1.5/8 x 12
-24	1.1/2	1.7/8 x 12
-32	2"	2.1/2 x 12
-40	2.1/2	3" x 12
-48	3"	3.1/2 x 12

PRESSURE SWITCHES (Category 4)

NEMA TYPE PRESSURE SWITCHES



- 1/4" BSP Thread
- 6mm Tube Connections
- Voltage: 220V
- Max Current: 16 Amps
- Standard Cut in Pressure: 6 Bar. Adjustable from 4-9 Bar.
- Standard Cut out Pressure: 8 Bar. See chart below for Cut-Out pressures if Cut-In pressure is adjusted.
- Control Accuracy: ±0.03 Bar
- Working Temperature: -25°C to +40°C

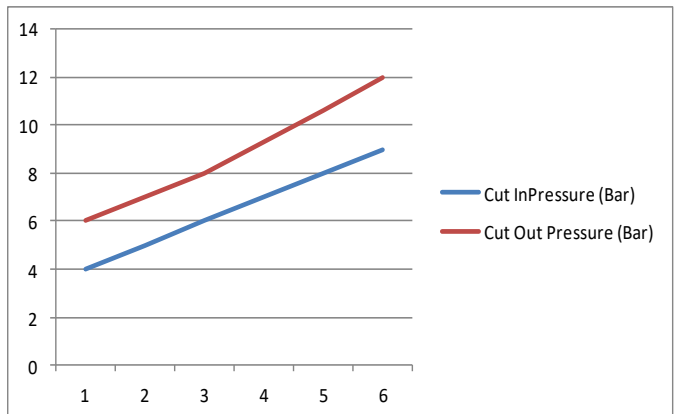

Code	Description
04-AD1-B	Single Port Pressure Switch. Compression
04-AD1-P	Single Port Pressure Switch. Push-In
04-AD4-B	4 Port Pressure Switch. Compression
04-AD4-P	4 Port Pressure Switch. Push-In

CONDOR PRESSURE SWITCHES

MDR2 Series - Single Phase
 1/4 BSP Female Connections
 Switching Capacity - 2.2 KW
 20 Amps at 240 Volts

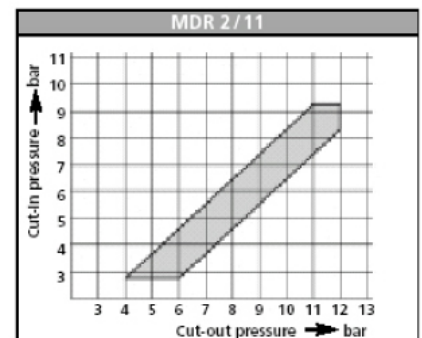
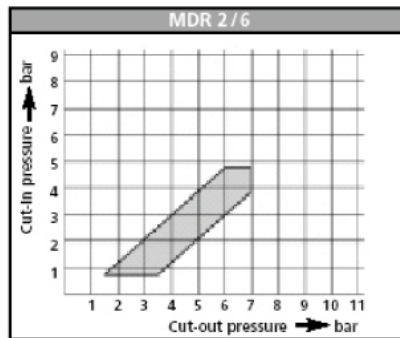

Code	Unloader	ON/OFF SWITCH	PORTS	Cut Out Pressure
04-MDR2/600			1	150-700 Kpa
04-MDR2/11003	✓	✓	1	400-1200 Kpa
04-MDR2/11007	✓	✓	4	400-1200 Kpa

MDR3 Series - 3 Phase
 1/4 BSP Female Connections
 Switching Capacity - 7.5 KW



- Pressure Ranges Available
 130 to 600 Kpa, 400 to 1100 Kpa, 600 to 1600 Kpa and 750 - 2500 Kpa.
- Optional On/Off Switch
- Thermal Overload Options if Required
 4 to 6.3 Amps, 6.3 to 10 Amps, 10 to 16 Amps, 16 to 20 Amps and 20 to 24 Amps.
- 4 Port Option available in 1100 and 1600 Kpa models.



SPARE PARTS
ALSO
AVAILABLE

COMPRESSOR VALVES (Category 4)



106SV Adjustable Pressure Relief Valves

Code	Male
04-NSV10604	1/4 BSP
04-NSV10606	3/8 BSP
04-NSV10608	1/2 BSP

Recommended Temperatures : 10°C to 100°C
 Minimum Adjustment : 7 Bar / 100 PSI
 Maximum Adjustment : 11 Bar / 160 PSI

The 106SV comes set at 11 Bar / 160 PSI with a plastic tamper proof cap for protection.

Relief valves can be ordered at a set pressure. These special valves are pinned and are not adjustable. Please contact the sales office for the available pressure ranges and availability.

These Relief Valves are designed to reset at 40-60% of their set pressure.

Cold Start Valves



Cold start valves bleed air from the compressor head during the first few pump revolutions, reducing motor starting torque requirements. These valves are especially helpful on oil-lubed pumps that may be subject to low temperatures and low starting voltages, such as a contractor unit that may sit outside overnight and is connected to a long extension cord. They can be installed into any convenient port upstream of the tank check valve.

Construction: Brass body and piston, stainless steel spring and fluorocarbon O-ring

Code	Inlet	Closing Pressure	Compressor Range
04-CS12	1/8 NPT	25 psi	1/2-2 HP
04-CS25	1/4 NPT	25 psi	2-5 HP

Load Genie (Unloading Check Valve)

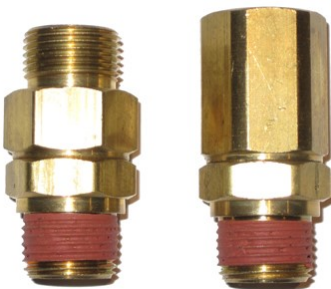

A compressor running in a "start-stop" mode operates more efficiently if the pressure trapped in the compressor head and discharge line is released after each pump-up cycle. This allows smoother starts and the use of a motor with lower starting torque. The most convenient way to release this trapped pressure is to use **Load Genie®** combination check and unloader valve. Simply install this unique valve in the compressor discharge line, and the **Load Genie®** does the rest.

The **Load Genie®** senses air flow when the compressor is running and closes an unloading orifice port. When airflow stops (such as when the pressure switch turns off the motor), the Load Genie® opens the unloading orifice to release head pressure, and a built-in check valve keeps receiver air from leaking back into the discharge line and compressor head.

Code	Tube	Male
04-NCA12	1/2	3/8 NPT

Code	Female	Male
04-NPA06	1/4 NPT	1/4 NPT
04-NPA12	3/8 NPT	3/8 NPT
04-NPA24	1/2 NPT	1/2 NPT
04-NPA48	3/4 NPT	3/4 NPT

COMPRESSOR VALVES (Category 4)

In Tank Check Valve Bodies

The **Super-Chek®** design has been proven over the last 15 years to be the standard for air compressor in-tank check valves. One-piece brass bodies, stainless steel springs, and glass-filled fluoropolymer poppets all add to long term reliability, while the eight discharge holes ensure quiet operation. The valves can be disassembled for cleaning or repair and are 100% tested for backflow leakage performance.



Maximum Pressure 450 psi / 3100 kpa
 Maximum Temperature 204° C / 400° F

Compression Fitting Inlet

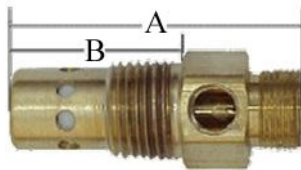

Code	Tube	Male	A (mm)	B (mm)	Hex (mm)
04-NRC3850	3/8	1/2 NPT	73	47.6	22.2
04-NRC5050	1/2	1/2 NPT	73	47.6	22.2
04-NRC7575	3/4	3/4 NPT	89	60.3	28.6
04-NRC7510	3/4	1" NPT	95.2	66.7	33.3

Female Thread Inlet

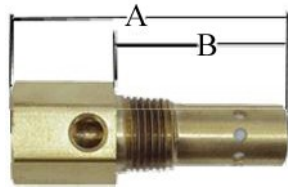

Code	Female	Male	A (mm)	B (mm)	Hex (mm)
04-NRP5050	1/2 NPT	1/2 NPT	76.2	47.6	25.4
04-NRP5075	1/2 NPT	3/4 NPT	88.9	63.5	28.6
04-NRP7575	3/4 NPT	3/4 NPT	82.5	57.1	30.1
04-NRP7510	3/4 NPT	1" NPT	88.9	63.5	33.3
04-NRP1010	1" NPT	1" NPT	98.4	66.6	38.1

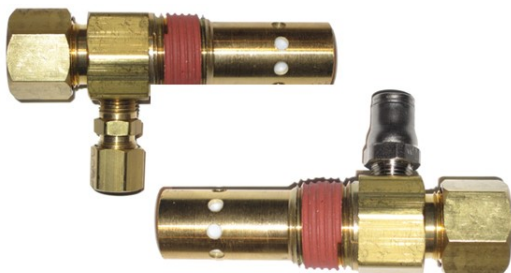
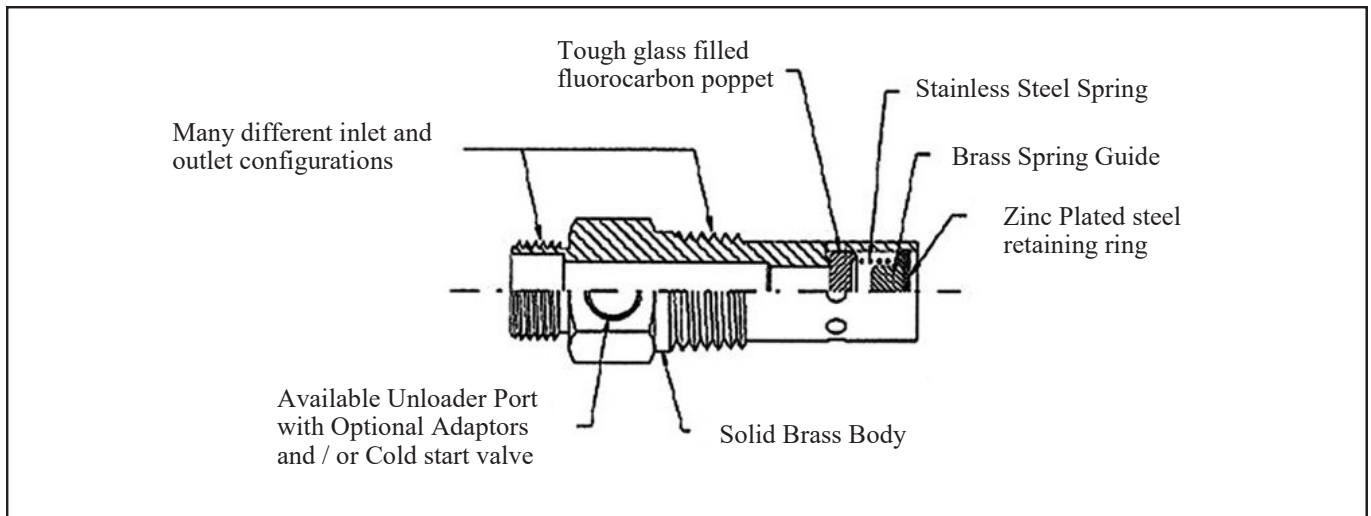

In Tank Check Valves Complete

Complete check valves also available supplied with Nut and Olive on Compression Inlet models and Compression or push-in fittings in the unloader port.

Contact the sales office for other combinations.

Code	Male	Inlet	Outlet
04-NRV108	1/2 NPT	1/2 Tube Compression	1/4 Tube Compression
04-NRV109	1/2 NPT	1/2 Tube Compression	1/4 Tube Push-In

COMPRESSOR VALVES (Category 4)

90° Compressor Non Return Valves

Code	Inlet	Outlet	Repair Kit
04-NRV90-06	3/8 Tube (Nut & Olive)	3/8 BSP Male	N/A
04-NRV90-08	1/2 Tube (BSP Flare)	1/2 BSP Male	04-NRV90K-08
04-NRV90-0812	1/2 BSP Flat	3/4 BSP Male	04-NRV90K-08
04-NRV90-12	3/4 Tube (BSP Flare)	3/4 BSP Male	04-NRV90K-12
04-NRV90-16F	1" Tube (BSP Flare)	1" BSP Female	04-NRV90K-16



- Brass Construction
- Made in Italy
- All Valves supplied with Nut and olive to suit 6mm tube. Contact the sales office if a different tube size is required.
- Flexible metal discharge hose available for 1/2 Non Return Valve.

Code	Length
04-CH08-325	325 mm
04-CH08-550	550mm

P25 Pilot Valve



The **P25** unloader is an industry standard. Details of construction include a precision machined, forged brass body, brass adjustment screws, and stainless steel ball spring.

Valve cut-in and cut-out pressures are factory set per customer specifications (if no specifications are given, valve is set at standards settings of 95-115 psi). Valve is also field adjustable.

Valve includes a mounting boss, tapped with a 3/8-16 UNC thread, a 1/4 NPT inlet and a 1/8 NPT outlet. Valve comes standard with unloading sleeve for piston engine warm up. Options include a toggle for one-hand unloading, a lock-out thumbscrew for dual control systems, and a 1/4 NPT nipple installed into the inlet port. Maximum cut-out pressure 250 psi, minimum cut-out pressure 60 psi. Maximum temperature 350°F.

Code : 04-P25

Mark III Load Genie



Code	Inlet	Outlet	Repair Kit
04-MK3A	1/2 NPT Female	1/2 NPT Male	04-MK3RK
04-MK3B	1/2 Compression	1/2 NPT Male	04-MK3RK
04-MK3C	1/2 Compression	1/2 Flare	04-MK3RK

The **Mark III Load Genie®** is a self-contained unloading valve and can be used wherever a continuous run compressor is required. The compressor may need to run continuously because the air demand is close to the maximum output of the compressor, or because the compressor is driven by a gasoline or diesel engine.

Since the **Mark III** is a "vent" unloader, no built-in head unloaders are required on the compressor. The **Mark III** contains all components required; the pilot valve, the vent valve and check valve. Simply install the **Mark III** in the discharge line between the compressor and the receiver. Valve cut-in and cut-out pressures factory set per customer specifications. Minimum cut-out pressure is 60 psi and maximum cut-out pressure is 250 psi. If no settings are specified, the valve is set at our standard setting of 115 psi cut-out and 95 psi cut-in. The valve is also field adjustable.

The **Mark III** is suitable for compressors of up to 30 SCFM. Details of construction include forged brass body, brass and zinc-plated steel internal components, stainless steel springs, and glass-filled fluoropolymer poppets.

COMPRESSOR VALVES (Category 4)

Mark II Load Genie



Code : 04-MK2

The Mark II Load Genie is a self-contained unloading valve, which can be used wherever a continuous run compressor is required. The compressor may need to run continuously because the air demanded is close to the maximum output of the compressor, or because the compressor is driven by a gasoline or diesel engine.

Since the Mark II is a “vent” unloader, no built-in head unloaders are required on the compressor. The Mark II contains all components required: the pilot valve, the vent valve, and a check valve. Simply install the Mark II in the discharge line between the compressor and receiver.

Valve cut-in and cut-out pressures are factory set per customer specifications. Minimum cut-out pressure is 60 PSI (415 kPa) and maximum cut-out pressure is 250 PSI (1725 kPa). The valve is also field adjustable. Details of construction include a forged brass body, brass and zinc-plated steel internal components, stainless steel springs, and glass filled fluoropolymer poppets.

Suitable for applications up to 20 SCFM.

1/2 NPT Female inlet with 1/2 NPT Male Outlet and 3/8 NPT Female vent outlet.

Mark IV Load Genie



Code : 04-MK4

The Mark IV Load Genie continues in the traditions of the original Mark II and the Mark III. The Mark IV combines all components required for a continuous run compressor application: the pilot valve, the vent valve, and the check valve. Since the Mark IV is a “vent” unloader, built-in compressor head unloaders are not required.

The compact size and the combination of straight-through or 90° flow design of the Mark IV make installation easy. Simply install the Mark IV into the air receiver and attach the compressor discharge line to the valve inlet. The Mark IV is suitable for compressors of up to 30 SCFM delivery.

Cut-in and cut-out pressure settings are factory set to 109 psi (751 kPa) cut-in and 138 psi (951 kPa) cut-out. Minimum cut-out pressure is 60 PSI (415 kPa) and maximum cutout pressure is 250 PSI (1725 kPa). The valve is also field adjustable.

Details of construction include a forged brass body, zinc plated steel internal components, fluorocarbon piston ring, stainless steel springs, and a glass filled fluoropolymer check valve poppet.

1/2 NPT Female inlet with 1/2 NPT Male Outlet and 3/8 NPT Female vent outlet.

BOURKE RELIEF VALVES (Category 4)

Bourke Relief Valves are all of brass construction, with the sealing member being of high tensile brass spherically machined, seating on a softer seat of mating curvature, allowing the sealing faces to be self aligning. The valve is top guided to give unrestricted flow up to the sealing faces. The construction of the valves makes it ideally suited to harsh environments. Bourke Valves are manufactured in accordance with Australia Standards (1271)

Valves are adjusted to within 3% of the set pressure which is stamped on the body and the reseating pressure is set to within 15% of the set pressure. All valves are pressure and leak tested with air.



Part Numbering System :



Type	Thread	Pressure
R - Ring Lift Valve	04 - 1/4 BSPT	035 - 242 KPA (35 PSI)
L - Lever Lift Valve	06 - 3/8 BSPT	050 - 345 KPA (50 PSI)
H - High Volume Valve	08 - 1/2 BSPT	090 - 620 KPA (90 PSI)
S - Soft Seat Valve	12 - 3/4 BSPT	100 - 690 KPA (100 PSI)
	16 - 1" BSPT	110 - 760 KPA (110 PSI)
	20 - 1.1/4 BSPT	125 - 860 KPA (125 PSI)
	24 - 1.1/2 BSPT	150 - 1035 KPA (150 PSI)
	32 - 2" BSPT	160 - 1100 KPA (160 PSI)
	54 - 1/4 NPT	180 - 1240 KPA (180 PSI)
	56 - 3/8 NPT	200 - 1380 KPA (200 PSI)
	58 - 1/2 NPT	250 - 1725 KPA (250 PSI)
	62 - 3/4 NPT	Other - Specify
	66 - 1" NPT	
	70 - 1.1/4 NPT	
	74 - 1.1/2 NPT	
	82 - 2" NPT	

Certificate of Conformance is available for all valves. Request for a certificate must be made at the time of placing an order, as it cannot be issued at a later date.

Specifications are subject to change without notice.

Ring Lift Valve

Available from 1/4" to 1/2" in BSPT and NPT.
 Pressure range - 5-250 PSI
 Stainless Steel Spring and Key Ring

1/2" Also available in Nitrile (Soft Seat) between 90 and 200 PSI

Lever Lift Valve

Available from 1/4" to 1/2" in BSPT and NPT.
 Pressure range - 5-250 PSI
 Stainless Steel Spring and Key Ring
 Zinc Plated Steel Lever.
 Max Temperature 220°C

High Volume Valve

Available from 1/2" to 2" in BSPT and NPT.
 Max Temperature 220°C
 Manganese Bronze Sealing Member

BOURKE VALVES

Size	Pressure Range	Spring	Lever	Height (mm)
1/2	50 - 250 PSI	Stainless Steel	Zinc Plated Steel	110
3/4	50 - 250 PSI	Stainless Steel	Zinc Plated Steel	110
1"	50 - 225 PSI	Stainless Steel	Zinc Plated Steel	115
1.1/4	50 - 225 PSI	Stainless Steel	Zinc Plated Steel	125
1.1/2	90 - 200 PSI	Chrome Alloy Steel	Stainless Steel	140
2"	90 - 200 PSI	Chrome Alloy Steel	Stainless Steel	150

BRASS NEEDLE VALVES (Category 4)



NV104
Female x
Female

Code	Female
04-NV10402	1/8 BSP
04-NV10404	1/4 BSP
04-NV10406	3/8 BSP
04-NV10408	1/2 BSP



NV41
Compression
x Male 90°

Code	Tube	Male
04-NV410302	3/16	1/8 BSPT
04-NV410402	1/4	1/8 BSPT



NVP42
Hose x
Male

Code	Hose	Male
04-NVP420302	3/16	1/8 BSPT
04-NVP420404	1/4	1/4 BSPT
04-NVP420504	5/16	1/4 BSPT
04-NVP420604	3/8	1/4 BSPT



NV104PM
Panel Mount
Female

Code	Female
04-NV104PM02	1/8 BSP
04-NV104PM04	1/4 BSP
04-NV104PM06	3/8 BSP
04-NV104PM08	1/2 BSP



NV41SO
Solder-On x
Male 90°

Code	Tube	Male
04-NV41SO0302	3/16	1/8 BSPT
04-NV41SO0402	1/4	1/8 BSPT
04-NV41SO0404	1/4	1/4 BSPT
04-NV41SO0502	5/16	1/8 BSPT
04-NV41SO0504	5/16	1/4 BSPT

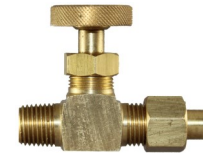

NVT3
Solder-On
x Male

Code	Hose	Male
04-NVT30302	3/16	1/8 BSPT
04-NVT30404	1/4	1/4 BSPT
04-NVT30504	5/16	1/4 BSPT



NV105
Male x
Male

Code	Female
04-NV10502	1/8 BSPT
04-NV10504	1/4 BSPT

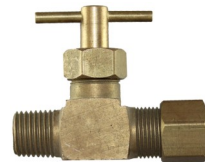

NV43
Compression
x Male

Code	Tube	Male
04-NV430604	3/8	1/4 BSPT



NVT7
Solder-On x
Solder-On

Code	Tube
04-NVT70303	3/16
04-NVT70404	1/4
04-NVT70505	5/16



NV4
Compression x
Compression

Code	Tube
04-NV4-03	3/16
04-NV4-04	1/4



NVA50
Male x
Male 90°

Code	Male A	Male B
04-NVA5002	1/8 BSPT	1/8 BSPT
04-NVA500402	1/4 BSPT	1/8 BSPT
04-NVA500404	1/4 BSPT	1/4 BSPT



NV404/808
Male x
Female

Code	Male	Female
04-NV80802	1/8 BSPT	1/8 BSP
04-NV40404	1/4 BSPT	1/4 BSP

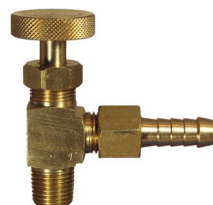

NVP40
Hose x
Male 90°

Code	Hose	Male
04-NVP400302	3/16	1/8 BSPT
04-NVP400304	3/16	1/4 BSPT
04-NVP400402	1/4	1/8 BSPT
04-NVP400404	1/4	1/4 BSPT
04-NVP400502	5/16	1/8 BSPT
04-NVP400504	5/16	1/4 BSPT
04-NVP400602	3/8	1/8 BSPT
04-NVP400604	3/8	1/4 BSPT

DRAIN COCKS



#30
Drain
Cock

Code	Male	Type
04-DC3002	1/8 BSPT	T-Bar
04-DC3004	1/4 BSPT	T-Bar
04-DC3006	3/8 BSPT	Hex
04-DC3008	1/2 BSPT	Hex
04-DCN3002	1/8 NPT	T-Bar
04-DCN3004	1/4 NPT	T-Bar
04-DCN3006	3/8 NPT	T-Bar



**High
Pressure
Stainless
Steel Valves
also
available.
Please
contact the sales office with
your requirements**

Maximum Working Pressure 150
psi (1000 kpa)

Temperature Rating : 0-120°C

Stem O-Ring - Nitrile

Suitable for air, water and
petroleum based products

BRASS LEVER TAPS (Category 4)



CT3
Compression
x Male

Code	Tube	Male
04-CT30402	1/4	1/8 BSPT
04-CT30404	1/4	1/4 BSPT
04-CT30502	5/16	1/8 BSPT
04-CT30504	5/16	1/4 BSPT



L101
Flare x
Flare

Code	Tube
04-L10104	1/4
04-L10106	3/8

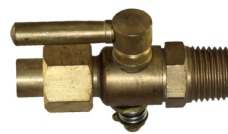

T3 / T6
Solder-On x
Male

Code	Tube	Male
04-T30302	3/16	1/8 BSPT
04-T30402	1/4	1/8 BSPT
04-T30404	1/4	1/4 BSPT
04-T30502	5/16	1/8 BSPT
04-T30504	5/16	1/4 BSPT
04-T60604	3/8	1/4 BSPT
04-T60606	3/8	3/8 BSPT
04-T60808	1/2	1/2 BSPT



DB1
Bent Drain
Cock

Code	Male
04-DB102	1/8 BSPT
04-DB104	1/4 BSPT
04-DB106	3/8 BSPT



L102
Flare x
Male

Code	Tube	Male
04-L1020402	1/4	1/8 BSPT

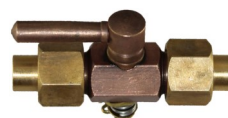

T7-T11
Solder-On
Tube x Tube

Code	Tube
04-T80404	1/4
04-T905	5/16
04-T100606	3/8



DT3
Drain
Cock

Code	Male
04-DT302	1/8 BSPT
04-DT304	1/4 BSPT
04-DT306	3/8 BSPT

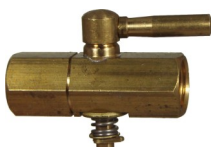

L104
Female x
Female

Code	Female
04-L10402	1/8 BSP
04-L10404	1/4 BSP



P51
Push / Pull
Sol x Male

Code	Tube	Male
04-P510502	5/16	1/8 BSPT



JT3
Hose x
Male

Code	Hose	Male
04-JT30302	3/16	1/8 BSPT
04-JT30402	1/4	1/8 BSPT
04-JT30502	5/16	1/8 BSPT
04-JT30602	3/8	1/8 BSPT

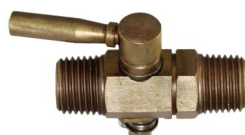

L105
Male x
Male

Code	Male
04-L10502	1/8 BSPT
04-L10504	1/4 BSPT



P52 Push / Pull
Solder
-On

Code	Tube
04-P520404	1/4



L404 / L808
Male x
Female

Code	Male	Female
04-L80802	1/8 BSPT	1/8 BSP
04-L40404	1/4 BSPT	1/4 BSP

PLEASE NOTE : Brass Lever Taps are not A.G.A. approved and are not suitable for use with any gas.

SCHRADER VALVES (Category 4)



Code	Male
04-JTV02	1/8 BSPT
04-JTVN02	1/8 NPT
04-JTVC	Core Only

Bulkhead Schrader Valves

Commonly used for air suspension inflation.
DOT Tube ends.

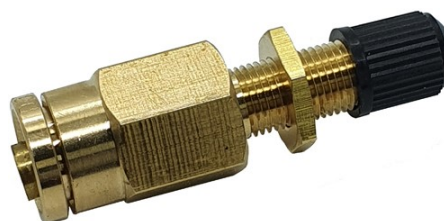

Code	Tube Size
04-DBSV04	1/4
04-DBSV06	3/8

TRUCK VALVES (Category 4)



V404
Truck Valve
Hose x Male 90°

Code	Hose	Male
04-V404P-6-6	3/8	3/8 NPT
04-V404P-10-6	5/8	3/8 NPT
04-V404P-10-8	5/8	1/2 NPT
04-V404P-12-6	3/4	3/8 NPT
04-V404P-12-8	3/4	1/2 NPT



V405
Truck Valve
Male x Female 90°

Code	Male	Female
04-V405P-6-6	3/8 NPT	3/8 NPT
04-V405P-8-8	1/2 NPT	1/2 NPT



V409
Truck Valve
Flare x Male 90°

Code	Tube	Male
04-V409F-8-8	1/2	1/2 NPT
04-V409F-10-8	5/8	1/2 NPT



V412
Truck Valve
Male x Flare 90°

Code	Male	Tube
04-V412F-10-8	1/2 NPT	5/8



Drain Valve with Cord

Code	Male Thread	Cord Length	Overall Height	Body Height	Hex Size
04-DV1421	1/4 NPT	60"	1.82	0.78	0.82

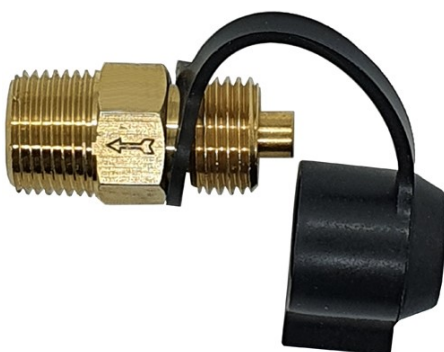

16mm Test Point Adaptors

For connecting testing equipment to check air brake systems. Complete with cap.

Code	Male Thread
04-TPM16	M16x1.5
04-TPN04	1/4 NPT
04-TPN06	3/8 NPT

INTERNAL COMPRESSION FITTINGS. (Category 5)

TUBE: Copper, Aluminium, Bundy,Nylon(with spigot for high pressure).

PRESSURE: Medium pressure ratings around 3500kpa/500psi decreasing as tube sizes increase and depending on the medium.

TEMPERATURE: 0°C to 120°C

TYPICAL USES: Airlines, Oil/Petrol lines, water lines.

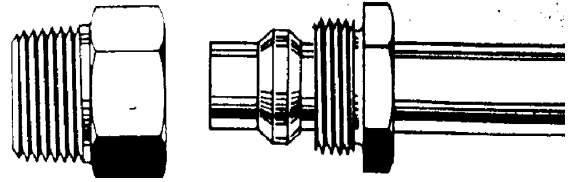

#100
Universal
Olive

Code	Tube
01100-02	1/8
01100-03	3/16
01100-04	1/4
01100-05	5/16
01100-06	3/8
01100-08	1/2
01100-10	5/8
01100-12	3/4
32-M.10004	4mm
32-M.10006	6mm



Z2
Tube
Nut

Code	Tube	Thread
05-002-02	1/8	9/32x26
05-002-03	3/16	3/8x24
05-002-04	1/4	7/16x24
05-002-05	5/16	1/2x24
05-002-06	3/8	9/16x24
05-002-08	1/2	3/4x24
05-002-10	5/8	7/8x20
05-002-12	3/4	1.025x18
05-302-04	4mm	M8x1
05-302-06	6mm	M10x1

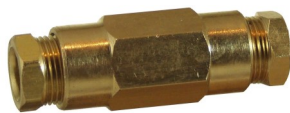

Z4
Double
Union

Code	Tube
05-004-02	1/8
05-004-03	3/16
05-004-04	1/4
05-004-05	5/16
05-004-06	3/8
05-004-08	1/2
05-004-10	5/8
05-004-12	3/4
05-304-04	4mm
05-304-06	6mm



Z3
Male
Connector

Code	Tube	Thread
05-003-0202	1/8	1/8 BSPT
05-003-0204	1/8	1/4 BSPT
05-003-0302	3/16	1/8 BSPT
05-003-0304	3/16	1/4 BSPT
05-003-0402	1/4	1/8 BSPT
05-003-0404	1/4	1/4 BSPT
05-003-0406	1/4	3/8 BSPT
05-003-0408	1/4	1/2 BSPT
05-003-0502	5/16	1/8 BSPT
05-003-0504	5/16	1/4 BSPT
05-003-0506	5/16	3/8 BSPT
05-003-0508	5/16	1/2 BSPT
05-003-0602	3/8	1/8 BSPT
05-003-0604	3/8	1/4 BSPT
05-003-0606	3/8	3/8 BSPT
05-003-0608	3/8	1/2 BSPT
05-003-0804	1/2	1/4 BSPT
05-003-0806	1/2	3/8 BSPT
05-003-0808	1/2	1/2 BSPT
05-003-0812	1/2	3/4 BSPT
05-003-1006	5/8	3/8 BSPT
05-003-1008	5/8	1/2 BSPT
05-003-1012	5/8	3/4 BSPT
05-003-1208	3/4	1/2 BSPT
05-003-1212	3/4	3/4 BSPT
05-303-0402	4mm	1/8 BSPT
05-303-0602	6mm	1/8 BSPT



Y5A
Stem
Elbow

Code	Tube	Stem
05-005A-03	3/16	3/16
05-005A-05	5/16	5/16
05-005A-06	3/8	3/8
05-005A-08	1/2	1/2



Y5
Male Elbow
Connector

Code	Tube	Thread
05-005-0202	1/8	1/8 BSPT
05-005-0204	1/8	1/4 BSPT
05-005-0302	3/16	1/8 BSPT
05-005-0304	3/16	1/4 BSPT
05-005-0402	1/4	1/8 BSPT
05-005-0404	1/4	1/4 BSPT
05-005-0406	1/4	3/8 BSPT
05-005-0502	5/16	1/8 BSPT
05-005-0504	5/16	1/4 BSPT
05-005-0506	5/16	3/8 BSPT
05-005-0602	3/8	1/8 BSPT
05-005-0604	3/8	1/4 BSPT
05-005-0606	3/8	3/8 BSPT
05-005-0608	3/8	1/2 BSPT
05-005-0804	1/2	1/4 BSPT
05-005-0806	1/2	3/8 BSPT
05-005-0808	1/2	1/2 BSPT
05-005-1212	3/4	3/4 BSPT
05-305-0402	4mm	1/8 BSPT
05-305-0602	6mm	1/8 BSPT



Y11
Elbow
Union

Code	Tube
05-011-02	1/8
05-011-03	3/16
05-011-04	1/4
05-011-05	5/16
05-011-06	3/8
05-011-08	1/2
05-011-10	5/8
05-011-12	3/4

INTERNAL COMPRESSION FITTINGS. (Category 5)



Z10
Female
Connector

Code	Tube	Thread
05-010-0202	1/8	1/8 BSP
05-010-0204	1/8	1/4 BSP
05-010-0302	3/16	1/8 BSP
05-010-0304	3/16	1/4 BSP
05-010-0402	1/4	1/8 BSP
05-010-0404	1/4	1/4 BSP
05-010-0502	5/16	1/8 BSP
05-010-0504	5/16	1/4 BSP
05-010-0506	5/16	3/8 BSP
05-010-0604	3/8	1/4 BSP
05-010-0606	3/8	3/8 BSP
05-010-0806	1/2	3/8 BSP
05-010-0808	1/2	1/2 BSP
05-010-1212	3/4	3/4 BSP



Y12
Male
Branch Tee

Code	Tube	Thread
05-012-0202	1/8	1/8 BSPT
05-012-0302	3/16	1/8 BSPT
05-012-0402	1/4	1/8 BSPT
05-012-0404	1/4	1/4 BSPT
05-012-0502	5/16	1/8 BSPT
05-012-0504	5/16	1/4 BSPT
05-012-0602	3/8	1/8 BSPT
05-012-0604	3/8	1/4 BSPT
05-212-0604	3/8	1/4 NPT
05-012-0806	1/2	3/8 BSPT
05-012-0808	1/2	1/2 BSPT
05-012-1212	3/4	3/4 BSPT



Y12A
Branch
Stem Tee

Code	Tube	Stem
05-012A-03	3/16	3/16
05-012A-04	1/4	1/4
05-012A-05	5/16	5/16
05-012A-08	1/2	1/2



Y13
Male
Run Tee

Code	Tube	Thread
05-013-0202	1/8	1/8 BSPT
05-013-0302	3/16	1/8 BSPT
05-013-0402	1/4	1/8 BSPT
05-013-0404	1/4	1/4 BSPT
05-013-0504	5/16	1/4 BSPT
05-013-0602	3/8	1/8 BSPT
05-013-0604	3/8	1/4 BSPT
05-013-0806	1/2	3/8 BSPT



Y13A
Run
Stem Tee

Code	Tube	Stem
05-013A-04	1/4	1/4



Y14
Tee
Union

Code	Tube
05-014-02	1/8
05-014-03	3/16
05-014-04	1/4
05-014-05	5/16
05-014-06	3/8
05-014-08	1/2
05-014-10	5/8
05-014-12	3/4

See Category 1 and 32 for
Spigots (Tube Inserts)



Y15
Female Elbow
Connector

Code	Tube	Thread
05-015-0202	1/8	1/8 BSP
05-015-0302	3/16	1/8 BSP
05-015-0304	3/16	1/4 BSP
05-015-0402	1/4	1/8 BSP
05-015-0404	1/4	1/4 BSP
05-015-0502	5/16	1/8 BSP
05-015-0504	5/16	1/4 BSP
05-015-0506	5/16	3/8 BSP
05-015-0604	3/8	1/4 BSP
05-015-0606	3/8	3/8 BSP
05-015-0806	1/2	3/8 BSP
05-015-0808	1/2	1/2 BSP



Z31
Bulkhead
Union

Code	Tube
05-031-03	3/16
05-031-04	1/4
05-031-06	3/8
05-031-08	1/2

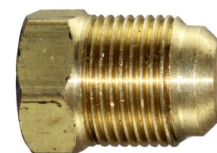

Z65
Tube
Plug

Code	Tube
05-065-02	1/8
05-065-03	3/16
05-065-04	1/4
05-065-05	5/16
05-065-06	3/8
05-065-08	1/2
05-065-10	5/8



Z72A
Tube
Reducer

Code	Tube	Tube
05-072A-0804	1/2	1/4



Also stocks a variety of tubes suitable for use with compression fittings, including nylon, Polyethylene, Polyurethane and Teflon



HOSETAILS (BARBED FITTINGS). (Category 6)



P3
Male Straight
Hose Tail

Code	Hose	Thread
06-U03-0103	1/16	10/32
06-003-0202	1/8	1/8 BSPT
06-U03-0203	1/8	10/32
06-003-0302	3/16	1/8 BSPT
06-003-0304	3/16	1/4 BSPT
06-203-0302	3/16	1/8 NPT
06-203-0304	3/16	1/4 NPT
06-M03-0318D	3/16	M18x1.25
06-003-0402	1/4	1/8 BSPT
06-003-0404	1/4	1/4 BSPT
06-003-0406	1/4	3/8 BSPT
06-003-0408	1/4	1/2 BSPT
06-203-0402	1/4	1/8 NPT
06-203-0404	1/4	1/4 NPT
06-203-0406	1/4	3/8 NPT
06-003-0502	5/16	1/8 BSPT
06-003-0504	5/16	1/4 BSPT
06-003-0506	5/16	3/8 BSPT
06-003-0508	5/16	1/2 BSPT
06-203-0502	5/16	1/8 NPT
06-203-0504	5/16	1/4 NPT
06-203-0506	5/16	3/8 NPT
06-003-0602	3/8	1/8 BSPT
06-003-0604	3/8	1/4 BSPT
06-003-0606	3/8	3/8 BSPT
06-003-0608	3/8	1/2 BSPT
06-003-0612	3/8	3/4 BSPT
06-203-0602	3/8	1/8 NPT
06-203-0604	3/8	1/4 NPT
06-203-0606	3/8	3/8 NPT
06-203-0608	3/8	1/2 NPT
06-M03-0612E	3/8	M12x1.5
06-M03-0616E	3/8	M16x1.5
06-M03-0622E	3/8	M22x1.5
06-003-0802	1/2	1/8 BSPT
06-003-0804	1/2	1/4 BSPT
06-003-0806	1/2	3/8 BSPT
06-003-0808	1/2	1/2 BSPT
06-003-0812	1/2	3/4 BSPT
06-003-0816	1/2	1" BSPT
06-203-0804	1/2	1/4 NPT
06-203-0806	1/2	3/8 NPT
06-203-0808	1/2	1/2 NPT
06-203-0812	1/2	3/4 NPT
06-M03-0816E	1/2	M16x1.5
06-M03-0822E	1/2	M22x1.5



P3 (Cont)
Male Straight
Hose Tail

Code	Hose	Thread
06-003-1004	5/8	1/4 BSPT
06-003-1006	5/8	3/8 BSPT
06-003-1008	5/8	1/2 BSPT
06-003-1012	5/8	3/4 BSPT
06-003-1016	5/8	1" BSPT
06-203-1006	5/8	3/8 NPT
06-203-1008	5/8	1/2 NPT
06-203-1012	5/8	3/4 NPT
06-003-1204	3/4	1/4 BSPT
06-003-1206	3/4	3/8 BSPT
06-003-1208	3/4	1/2 BSPT
06-003-1212	3/4	3/4 BSPT
06-003-1216	3/4	1" BSPT
06-203-1208	3/4	1/2 NPT
06-203-1212	3/4	3/4 NPT
06-M03-1222E	3/4	M22x1.5
06-M03-1226E	3/4	M26x1.5
06-003-1408	7/8	1/2 BSPT
06-003-1608	1"	1/2 BSPT
06-003-1612	1"	3/4 BSPT
06-003-1616	1"	1" BSPT
06-003-1620	1"	1.1/4 BSPT
06-203-1612	1"	3/4 NPT
06-203-1616	1"	1" NPT
06-003-2008	1.1/4	1/2 BSPT
06-003-2016	1.1/4	1" BSPT
06-003-2020	1.1/4	1.1/4 BSPT
06-003-2024	1.1/4	1.1/2 BSPT
06-003-2424	1.1/2	1.1/2 BSPT
06-003-2432	1.1/2	2" BSPT
06-003-3224	2"	1.1/2 BSPT
06-003-3232	2"	2" BSPT
06-003-4040	2.1/2	2.1/2 BSPT
06-003-4848	3"	3" BSPT
06-003-6464	4"	4" BSPT



SP3
Swivel Male
Hose Tail

Code	Hose	Thread
06-003S-0404	1/4	1/4 BSPT
06-003S-0604	3/8	1/4 BSPT
06-003S-0606	3/8	3/8 BSPT
06-003S-0608	3/8	1/2 BSPT
06-003S-0808	1/2	1/2 BSPT
06-003S-0812	1/2	3/4 BSPT
06-003S-1212	3/4	3/4 BSPT
06-003S-1616	1"	1" BSPT



P3I
Inv Flare Male
Hose Tail

Code	Hose	Tube	Thread
06-I03-0504	5/16	1/4	7/16x24
06-I03-0505	5/16	5/16	1/2x20
06-I03-0506	5/16	3/8	5/8x18
06-I03-0605	3/8	5/16	1/2x20
06-I03-0606	3/8	3/8	5/8x18



P5
Nut & Tail
Cone Seat

Code	Hose	Thread
06-005-0302	3/16	1/8 BSP
06-005-0304	3/16	1/4 BSP
06-005-0404	1/4	1/4 BSP
06-005-0406	1/4	3/8 BSP
06-005-0408	1/4	1/2 BSP
06-205-0404	1/4	1/4 NPSM
06-005-0504	5/16	1/4 BSP
06-005-0506	5/16	3/8 BSP
06-005-0508	5/16	1/2 BSP
06-005-0604	3/8	1/4 BSP
06-005-0606	3/8	3/8 BSP
06-005-0608	3/8	1/2 BSP
06-205-0606	3/8	3/8 NPSM
06-005-0806	1/2	3/8 BSP
06-005-0808	1/2	1/2 BSP
06-005-1212	3/4	3/4 BSP
06-005-1616	1"	1" BSP

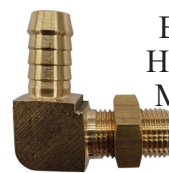

Brass Elbow . 1/2"
Hose Tail x M16x1.5
Male with a locknut

Code : 06-M06L-0816

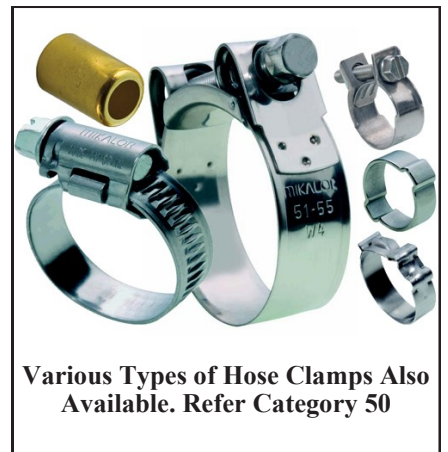

Various Types of Hose Clamps Also Available. Refer Category 50

HOSETAILS (BARBED FITTINGS). (Category 6)



P6
Male Elbow
Hose Tail

Code	Hose	Thread
06-006-0202	1/8	1/8 BSPT
06-006-0302	3/16	1/8 BSPT
06-006-0304	3/16	1/4 BSPT
06-206-0302	3/16	1/8 NPT
06-006-0402	1/4	1/8 BSPT
06-006-0404	1/4	1/4 BSPT
06-006-0406	1/4	3/8 BSPT
06-006-0408	1/4	1/2 BSPT
06-206-0402	1/4	1/8 NPT
06-206-0404	1/4	1/4 NPT
06-006-0502	5/16	1/8 BSPT
06-006-0504	5/16	1/4 BSPT
06-006-0506	5/16	3/8 BSPT
06-006-0508	5/16	1/2 BSPT
06-206-0502	5/16	1/8 NPT
06-206-0504	5/16	1/4 NPT
06-206-0506	5/16	3/8 NPT
06-006-0602	3/8	1/8 BSPT
06-006-0604	3/8	1/4 BSPT
06-006-0606	3/8	3/8 BSPT
06-006-0608	3/8	1/2 BSPT
06-206-0602	3/8	1/8 NPT
06-206-0604	3/8	1/4 NPT
06-206-0606	3/8	3/8 NPT
06-206-0608	3/8	1/2 NPT
06-006-0804	1/2	1/4 BSPT
06-006-0806	1/2	3/8 BSPT
06-006-0808	1/2	1/2 BSPT
06-006-0812	1/2	3/4 BSPT
06-206-0804	1/2	1/4 NPT
06-206-0806	1/2	3/8 NPT
06-206-0808	1/2	1/2 NPT
06-006-1004	5/8	1/4 BSPT
06-006-1006	5/8	3/8 BSPT
06-006-1008	5/8	1/2 BSPT
06-206-1006	5/8	3/8 NPT
06-206-1008	5/8	1/2 NPT
06-006-1208	3/4	1/2 BSPT
06-006-1212	3/4	3/4 BSPT
06-006-1216	3/4	1" BSPT
06-206-1208	3/4	1/2 NPT
06-206-1212	3/4	3/4 NPT
06-006-1612	1"	3/4 BSPT
06-006-1616	1"	1" BSPT

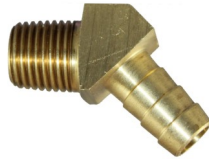

P6D
Male 45°
Hose Tail

Code	Hose	Thread
06-006D-0402	1/4	1/8 BSPT
06-006D-0404	1/4	1/4 BSPT
06-006D-0406	1/4	3/8 BSPT
06-006D-0502	5/16	1/8 BSPT
06-006D-0504	5/16	1/4 BSPT
06-006D-0506	5/16	3/8 BSPT
06-006D-0602	3/8	1/8 BSPT
06-006D-0604	3/8	1/4 BSPT
06-006D-0606	3/8	3/8 BSPT
06-006D-0802	1/2	1/8 BSPT
06-006D-0804	1/2	1/4 BSPT
06-006D-0806	1/2	3/8 BSPT
06-006D-1006	5/8	3/8 BSPT



P6I
Inv Flare Male
Elbow Hose Tail

Code	Hose	Tube	Thread
06-106-0404	1/4	1/4	7/16x24
06-106-0405	1/4	5/16	1/2x20
06-106-0505	5/16	5/16	1/2x20
06-106-0605	3/8	3/8	1/2x20
06-106-0606	3/8	3/8	5/8x18



P7
Hose Tail
Joiner

Code	Hose
06-007-02	1/8
06-007-03	3/16
06-007-04	1/4
06-007-05	5/16
06-007-06	3/8
06-007-08	1/2
06-007-10	5/8
06-007-12	3/4
06-007-16	1"



P7R
Reducing
Hose Joiner

Code	Hose	Hose
06-007R-0402	1/4	1/8
06-007R-0503	5/16	3/16
06-007R-0504	5/16	1/4
06-007R-0604	3/8	1/4
06-007R-0605	3/8	5/16
06-007R-0805	1/2	5/16
06-007R-0806	1/2	3/8
06-007R-1005	5/8	5/16
06-007R-1006	5/8	3/8
06-007R-1008	5/8	1/2
06-007R-1208	3/4	1/2
06-007R-1210	3/4	5/8
06-007R-1410	7/8	5/8
06-007R-1612	1"	3/4



P11
Hose Tail
Elbow

Code	Hose
06-011-03	3/16
06-011-04	1/4
06-011-05	5/16
06-011-06	3/8
06-011-08	1/2
06-011-10	5/8
06-011-12	3/4
06-011-16	1"

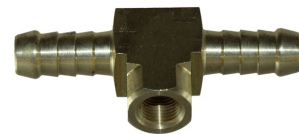

P12F
Female
Branch
Hose Tee

Code	Hose	Female
06-012F-0402	1/4	1/8 BSP
06-012F-0502	5/16	1/8 BSP
06-212F-0502	5/16	1/8 NPT
06-012F-0602	3/8	1/8 BSP
06-012F-0604	3/8	1/4 BSP
06-212F-0602	3/8	1/8 NPT
06-012F-0802	1/2	1/8 BSP
06-012F-0804	1/2	1/4 BSP
06-212F-0802	1/2	1/8 NPT

HOSETAILS (BARBED FITTINGS). (Category 6)



P10
Female Strght
Hose Tail

Code	Hose	Thread
06-010-0202	1/8	1/8 BSP
06-010-0302	3/16	1/8 BSP
06-010-0304	3/16	1/4 BSP
06-210-0302	3/16	1/8 NPT
06-210-0304	3/16	1/4 NPT
06-010-0402	1/4	1/8 BSP
06-010-0404	1/4	1/4 BSP
06-010-0406	1/4	3/8 BSP
06-010-0408	1/4	1/2 BSP
06-210-0402	1/4	1/8 NPT
06-210-0404	1/4	1/4 NPT
06-010-0502	5/16	1/8 BSP
06-010-0504	5/16	1/4 BSP
06-010-0506	5/16	3/8 BSP
06-010-0508	5/16	1/2 BSP
06-210-0504	5/16	1/4 NPT
06-010-0602	3/8	1/8 BSP
06-010-0604	3/8	1/4 BSP
06-010-0606	3/8	3/8 BSP
06-010-0608	3/8	1/2 BSP
06-210-0604	3/8	1/4 NPT
06-210-0606	3/8	3/8 NPT
06-010-0804	1/2	1/4 BSP
06-010-0806	1/2	3/8 BSP
06-010-0808	1/2	1/2 BSP
06-010-0812	1/2	3/4 BSP
06-210-0806	1/2	3/8 NPT
06-010-1004	5/8	1/4 BSP
06-010-1006	5/8	3/8 BSP
06-010-1008	5/8	1/2 BSP
06-010-1012	5/8	3/4 BSP
06-010-1208	3/4	1/2 BSP
06-010-1212	3/4	3/4 BSP



P13
Male Run
Hose Tee

Code	Hose	Thread
06-013-0806	1/2	3/8 BSPT

Brass Tee . 1/2''
Hose Tail x
M16x1.5 Female
x M16x1.5 Male
with a locknut



Code : 06-M13L-08MF16



P12
Male Branch
Hose Tee

Code	Hose	Thread
06-012-0302	3/16	1/8 BSPT
06-012-0402	1/4	1/8 BSPT
06-012-0404	1/4	1/4 BSPT
06-012-0502	5/16	1/8 BSPT
06-012-0504	5/16	1/4 BSPT
06-012-0602	3/8	1/8 BSPT
06-012-0604	3/8	1/4 BSPT
06-012-0606	3/8	3/8 BSPT
06-012-0608	3/8	1/2 BSPT
06-012-0804	1/2	1/4 BSPT
06-012-0806	1/2	3/8 BSPT
06-012-0808	1/2	1/2 BSPT
06-012-1006	5/8	3/8 BSPT
06-012-1208	3/4	1/2 BSPT
06-012-1212	3/4	3/4 BSPT
06-012-1616	1"	1" BSPT



P14
Hose Tail
Tee

Code	Hose
06-014-02	1/8
06-014-03	3/16
06-014-04	1/4
06-014-05	5/16
06-014-06	3/8
06-014-08	1/2
06-014-10	5/8
06-014-12	3/4
06-014-16	1"



P75
Hose Tail
Y-Piece

Code	Hose
06-075-03	3/16
06-075-04	1/4
06-075-05	5/16
06-075-06	3/8
06-075-08	1/2
06-075-10	5/8
06-075-12	3/4



P14R
Reducing
Hose Tee

Code	Hose	Hose
06-014R-1006	5/8	3/8
06-014R-1008	5/8	1/2
06-014R-1206	3/4	3/8
06-014R-1210	3/4	5/8



P25
Nut & Tail
Flat Seat

Code	Hose	Thread
06-025-0808	1/2	1/2 BSP
06-025-0812	1/2	3/4 BSP
06-025-0816	1/2	1" BSP
06-025-1212	3/4	3/4 BSP
06-025-1216	3/4	1" BSP
06-025-1616	1"	1" BSP
06-025-1620	1"	1.1/4 BSP
06-025-2020	1.1/4	1.1/4 BSP
06-025-2024	1.1/4	1.1/2 BSP
06-025-2424	1.1/2	1.1/2 BSP
06-025-2432	1.1/2	2" BSP
06-025-3232	2"	2" BSP
06-025-4040	2.1/2	2.1/2 BSP
06-025-4848	3"	3" BSP
06-025-6464	4"	4" BSP

Spare Washers for P25 fittings also available

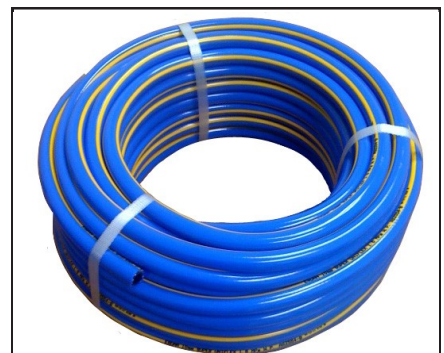

Various types and sizes of hose available.
See categories 13 and 42

BLOWGUNS (Category 7)

224 Series Blowguns

1/4 BSP Brass Inlet

Heavy Duty Blue Plastic Body

Display box available when purchasing 07-BG224 in lots of 10

Code	Nozzle
07-BG224	Standard 100mm
07-BG224L	Extended 325mm
07-BG224LL	Extended 500mm

600 Series Blowguns

Adjustable Nozzle

1/4 BSP

1/4 BSP

Code
07-BG600

- Heavy duty metal blowgun.
- Standard 100mm nozzle plus flow control nozzle.
- 1/4 BSP Top and Bottom Inlets.

Code
07-BG620

Top Lever Metal Blowguns with Rubber Tipped Nozzle

- Heavy Duty Metal Construction
- 100mm nozzle
- 1/4 BSP Inlet

PCL

Conical Nozzle Blowgun with Rubber Tip

- Suitable for Air and Water
- Trigger Adjustable Airflow
- 1/4 BSP Inlet

Code
07-BG5002

48"

Code
07-BG5113-48

- 48" Long Nozzle
- Heavy Duty Metal Construction
- 1/4 BSP Inlet

BLOWGUNS (Category 7)

Jamec Blowguns

Airmaster Range

1/4 BSP Brass Inlets.
Plastic Body

07-BGJ774

Code	Description
07-BGJ766	35" Nozzle
07-BGJ771	Conical Nozzle
07-BGJ774	18" Nozzle
07-BGJ780	Safe-n-Quiet Nozzle



07-BGJ780



07-BGJ771



07-BGJ766

Power Range

07-BGJ600

Code	Description
07-BGJ600	85mm Angled Nozzle.
07-BGJ608	18" Nozzle
07-BGJ610	Conical Nozzle

1/4 BSP Inlets.
All Metal Body



07-BGJ610

07-BGJ608

Spare Nozzles for Airmaster & Power Range

Code	Description
07-BGJ602	85mm Angled Nozzle.
07-BGJ609	18" Nozzle
07-BGJ619	35" Nozzle
07-BGJ781	Safe-n-Quiet Nozzle



07-BGJ609



07-BGJ602

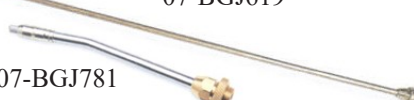

07-BGJ781

07-BGJ619

BLOWGUNS (Category 7)

Jamec Blowguns



07-BGJ640

Dustmaster Pistol Grip

- 1/4 BSP Brass Inlet
- All Metal Body



07-BGJ700

Water Dispenser

- 1/4 BSP Inlet
- Dispenses 10 litres of water per minute at 60PSI

Jamec Brass Blowguns

Code	Description
07-BGJ411	411 Short Nose Blowgun
07-BGJ412	412 Long Nose Blowgun



1/4 BSP Inlets



Legris Safety Blowgun

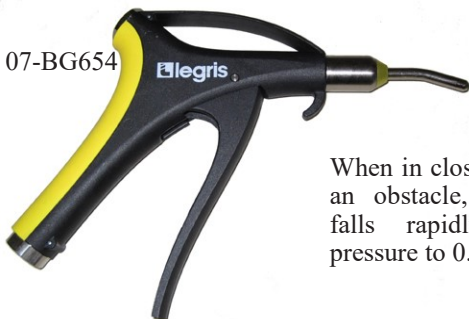

07-BG654

When in close proximity to an obstacle, the pressure falls rapidly, restricting pressure to 0.5 bar.

Custom Blowgun Kits



- Available with quick couplers or threaded hose ends.
- Available with PVC hose, Polyurethane spiral hoses or nylon self sore hose.
- Contact the office for your requirements.



Also have a large range of quick disconnect couplers suitable for air applications and tyre inflation equipment. Refer to Category 8 or contact the sales office for more information.

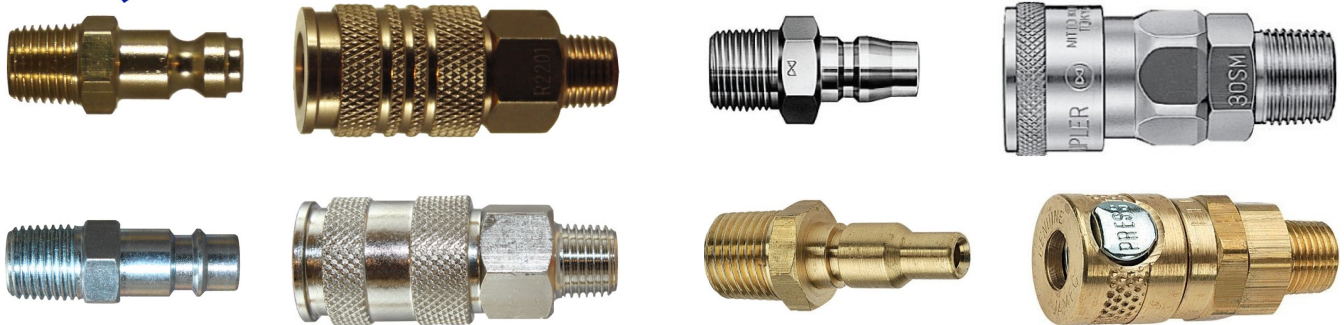

BLOWGUNS (Category 7)

Wundergun - Air Blower and Vacuum Gun Kit



Code : 07-WG5005

- Air Vacuum for Workshop, Car, Boat or Home
- Solid metal Air Blower for Workshop
- 3 Different Attachable Nozzles

NOZZLES AND WASHDOWN GUNS (Category 7)



3/4 Fire Hose Reel Nozzle

Code : 07-FHRN12



Brass Fire Hose Nozzles

Code	Female
07-BFN16	1" BSP
07-BFN24	1.1/2 BSP



Plastic Fire Hose Nozzles

Code	Female
07-PJN025	1" BSP
07-PJN038	1.1/2 BSP



Brass Fixed Fire Hose Nozzles

Code	Male
07-BN08	1/2 BSPT
07-BN12	3/4 BSPT



Brass Fire Nozzle to suit 3/4 Garden Hose Couplers

Code : 07-FN12



Insulated Water Nozzle 3/4 BSP Female

Code : 07-SN75



Original Dinga Hot Wash Gun

- Max Temperature: 80°C
- Working Pressure: 25bar (360psi)
- Water Flow: 25litres per min @ 5bar
- 1/2" BSP port size

Code: 07-DINGA

The German made DINGA hot wash gun is an extremely tough and durable water saving gun thanks to its high quality brass and stainless steel construction. It's rubber jacket protects the gun against shock, heat and cold conditions. It is also resistant to acidic and alkaline fluids.

The desired jet strength can be adjusted continuously from a fine spray mist to a concentrated jet.

SPARE PARTS AVAILABLE	
Code	Description
07-DPS	Rubber Protection Sleeve
07-DH	Rubber Handle
07-DJET	Nozzle Jet
07-DBOLT	Valve Bolt
07-DSPRING	Spring

TYRE INFLATORS (Category 7)

PCL MK4 TYRE INFLATOR



Code : 07-PCLMK4

The new AIRFORCE® MK4 Tyre Inflator is as robust as ever and highly accurate, offering leading inflation and deflation rates and high performance for both indoor and outdoor applications. Meanwhile the redesigned piston and seal arrangement means increased accuracy - cycle tests now give over 400,000 inflation cycles at 100% accuracy - over 50% more than previously!

By increasing the size of the viewing window to give a 20% larger field of view, and altering the graphic print to give a clearer scale reading the new gauge is even more user friendly.

With a new, modern slim line body design the gauge is now lighter yet more ergonomic to give increased comfort in use.

Digital Tyre Inflator



- Non Sealing Tyre Inflator
- Digital gauge measuring kpa, bar and psi

Code : 07-TI201D

Jamec Bar Style Inflator

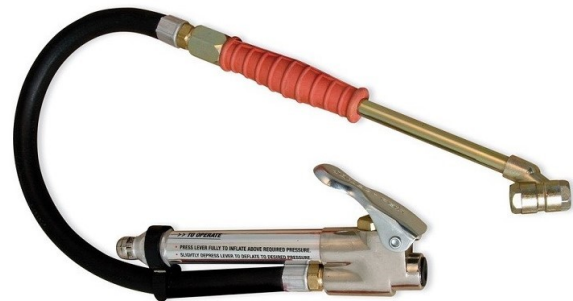

Code : 07-TI100

- Pressed steel operating lever
- Stainless steel spring
- Aluminium reader bar

PCL Single Barrel Foot Pump



Code : 07-FP4H02/3

- Steel construction for added strength
- Anti corrosive finish
- Barrel pressure sealed to prevent leakage
- Gauge calibrated 0-100 psi and 0-7 bar

Jamec Dial Gauge Inflator



Code : 07-TI135

- 50mm gauge
- Clip on chuck

PCL 4 in 1 Tyre Valve Tool

- Manufactured from case-hardened mild steel
- Zinc-plated finish

Code : 07-TVT05



This versatile 4-in-1 tool offers these functions:

1. Rethread the external part of the valve stem
2. Rethread the inside of the valve stem
3. Remove the valve core
4. Extract a damaged valve core

TYRE CHUCKS (Category 7)



Clip on Non-sealing chuck with 1/4 Hosetail

Code	Type
07-TC292	Standard Bore
07-TC294	Large Bore



Clip on angled chuck. 1/4 BSP Female

Code	Type
07-TC301	Sealing
07-TC460	Non Sealing



Straight Clip on chuck. 1/4 BSP Female

Code	Type
07-TC446	Sealing
07-TC447	Non Sealing



Hold on sealing angled chuck. 1/4 BSP Female

Code : 07-TC300

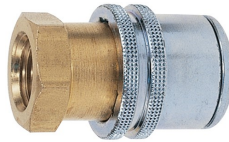

Clip on sealing sleeve type chuck. 1/4 NPT Female

Code : 07-TC340



Large Bore Clip on chuck. 1/4 BSP Female

Code	Type
07-TC498	Sealing
07-TC497	Non Sealing



Hold on dual chuck. 1/4 BSP Female With Rubber Handle

Code	Type
07-TC302	Sealing
07-TC465	Non Sealing



Hold on sealing dual chuck. 1/4 BSP Female

Code : 07-TC304

A sealing chuck is used when air is supplied directly from the air line to the tyre valve. A non-return valve unseats on connection allowing air to flow and re-seals on disconnection

A non sealing chuck is used with tyre inflators and gauges that have their own internal valve.



Clip on sealing dual chuck. 1/4 BSP Female with Rubber Handle

Code : 07-TC303

TYRE GAUGES (Category 7)



- 50mm Face
- 0-60psi Pressure Range
- Housing: Steel
- Ring: Chrome
- Stem with release button

Code	Chuck
07-TG012	Straight
07-TG032	Angled

Truck Tyre Gauge

Code : 07-TG41



- 50mm Face
- 0-160psi Pressure
- Housing: Steel
- Ring: Chrome
- Release button
- NBR Braided Hose
- Dual Chuck

Long Reach Truck Tyre Gauge



Maximum Pressure : 150psi / 1000kpa

Code : 07-TG40

JAMEC AIR COUPLERS (Category 8)

310 Series Couplings (Single Button)



310F
Female Coupling

	Brass	Steel
Thread	Code	Code
1/4 BSP	08-J310F4	08-J310F4S
3/8 BSP	08-J310F6	08-J310F6S
1/2 BSP	08-J310F8	08-J310F8S



310M
Male Coupling

	Brass	Steel
Thread	Code	Code
1/8 BSPT	08-J310M2	
1/4 BSPT	08-J310M4	08-J310M4S
3/8 BSPT	08-J310M6	08-J310M6S
1/2 BSPT	08-J310M8	08-J310M8S



310T
Hose Coupling

	Brass
Hose	Code
1/4	08-J310T4
5/16	08-J310T5
3/8	08-J310T6
1/2	08-J310T8



310TWT
Twin Coupling

Code
08-J310TWT

320 Series Couplings (Double Button)



320F
Female Coupling

	Brass
Thread	Code
1/4 BSP	08-J320F4
3/8 BSP	08-J320F6
1/2 BSP	08-J320F8



320M
Male Coupling

	Brass
Thread	Code
1/4 BSPT	08-J320M4
3/8 BSPT	08-J320M6
1/2 BSPT	08-J320M8



320T
Hose Coupling

	Brass
Hose	Code
3/8	08-J320T6

31 Series Adaptors (For 310 & 320 Series Couplings)

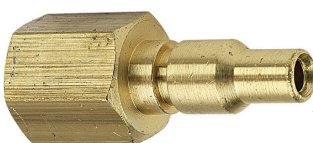

31F
Female Adaptor

	Brass	Steel
Thread	Code	Code
1/8 BSP	08-J31F2	08-J31F2S
1/4 BSP	08-J31F4	08-J31F4S
3/8 BSP	08-J31F6	08-J31F6S
Schrader	08-J31SHF	

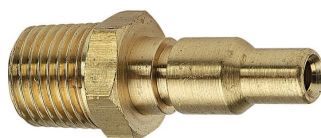

31M
Male Adaptor

	Brass	Steel
Thread	Code	Code
1/8 BSPT	08-J31M2	08-J31M2S
1/4 BSPT	08-J31M4	08-J31M4S
3/8 BSPT	08-J31M6	08-J31M6S
1/2 BSPT	08-J31M8	



31T
Hose Adaptor

	Brass	Steel
Hose	Code	Code
3/16	08-J31T3	
1/4	08-J31T4	08-J31T4S
5/16	08-J31T5	08-J31T5S
3/8	08-J31T6	08-J31T6S
1/2	08-J31T8	08-J31T8S

JAMEC AIR COUPLERS (Category 8)

330 Series Couplings



330F
Female
Coupling

Thread	Brass Code
1/4 BSP	08-J330F4
3/8 BSP	08-J330F6
1/2 BSP	08-J330F8



330M
Male
Coupling

Thread	Brass Code
1/4 BSPT	08-J330M4
3/8 BSPT	08-J330M6
1/2 BSPT	08-J330M8

33 Series Adaptors (For 330 Couplings)



33F
Female
Adaptor

Thread	Brass Code
1/4 BSP	08-J33F4
1/2 BSP	08-J33F8



33M
Male
Adaptor

Thread	Brass Code
1/4 BSPT	08-J33M4
3/8 BSPT	08-J33M6
1/2 BSPT	08-J33M8



33T
Hose
Adaptor

Hose	Brass Code
3/8	08-J33T6
1/2	08-J33T8

340 Series Couplings



340F
Female
Coupling

Thread	Brass Code
3/8 BSP	08-J340F6
1/2 BSP	08-J340F8



340M
Male
Coupling

Thread	Brass Code
3/8 BSPT	08-J340M6
1/2 BSPT	08-J340M8

34 Series Adaptors (For 340 Couplings)



34M
Male
Adaptor

Thread	Brass Code
1/4 BSPT	08-J34M4
3/8 BSPT	08-J34M6
1/2 BSPT	08-J34M8



34T
Hose
Adaptor

Hose	Brass Code
3/8	08-J34T6
1/2	08-J34T8



AIR COUPLERS (Category 8)

Hi-Cupla Standard Series. (NOTE : Standard Material is Steel)



PF
BSP Female
Plug

Size	Steel Code	Brass Code	Stainless Steel Code
1/4	08-NH-20PF	08-NHB-20PF	08-NHSS-20PF
3/8	08-NH-30PF	08-NHB-30PF	08-NHSS-30PF
1/2	08-NH-40PF	08-NHB-40PF	08-NHSS-40PF



SF
BSP Female
Socket

Size	Steel Code	Brass Code	Stainless Steel Code
1/4	08-NH-20SF	08-NHB-20SF	08-NHSS-20SF
3/8	08-NH-30SF	08-NHB-30SF	08-NHSS-30SF
1/2	08-NH-40SF	08-NHB-40SF	08-NHSS-40SF



PH
Hose
Plug

Size	Steel Code	Brass Code	Stainless Steel Code
1/4	08-NH-20PH	08-NHB-20PH	08-NHSS-20PH
3/8	08-NH-30PH	08-NHB-30PH	08-NHSS-30PH
1/2	08-NH-40PH	08-NHB-40PH	08-NHSS-40PH



SH
Hose
Socket

Size	Steel Code	Brass Code	Stainless Steel Code
1/4	08-NH-20SH	08-NHB-20SH	08-NHSS-20SH
3/8	08-NH-30SH	08-NHB-30SH	08-NHSS-30SH
1/2	08-NH-40SH	08-NHB-40SH	08-NHSS-40SH



PM
BSPT Male
Plug

Size	Steel Code	Brass Code	Stainless Steel Code
1/8	08-NH-10PM		
1/4	08-NH-20PM	08-NHB-20PM	08-NHSS-20PM
3/8	08-NH-30PM	08-NHB-30PM	08-NHSS-30PM
1/2	08-NH-40PM	08-NHB-40PM	08-NHSS-40PM



SM
BSPT Male
Socket

Size	Steel Code	Brass Code	Stainless Steel Code
1/4	08-NH-20SM	08-NHB-20SM	08-NHSS-20SM
3/8	08-NH-30SM	08-NHB-30SM	08-NHSS-30SM
1/2	08-NH-40SM	08-NHB-40SM	08-NHSS-40SM



Nitto
Twin
Coupling

Code
08-NH-TWT

Dust Cap for Hi-Cupla Sockets

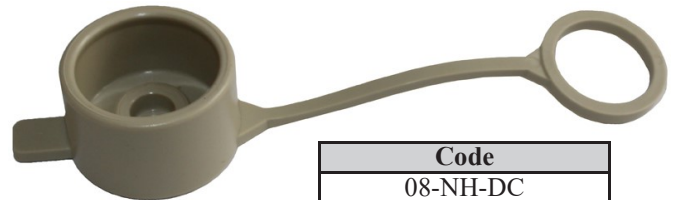

Code
08-NH-DC



Hi-Cupla
Seals

Code	Material	Temp Rating
08-NH-SN	Nitrile (Standard)	-20°C to +80°C
08-NH-SV	Viton	-20°C to +180°C

Dust Plug for Hi-Cupla Plugs

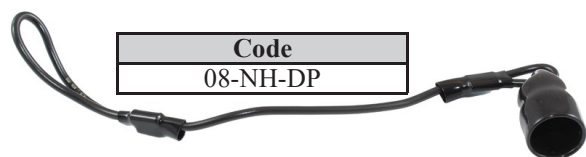

Code
08-NH-DP



AIR COUPLERS (Category 8)

Hi-Cupla One Touch 200 Series



200SF
BSP Female
Socket

Size	Steel
	Code
1/4	08-NH-200-20SF
3/8	08-NH-200-30SF
1/2	08-NH-200-40SF



200SH
Hose
Socket

Size	Steel
	Code
1/4	08-NH-200-20SH
3/8	08-NH-200-30SH
1/2	08-NH-200-40SH



200SM
BSPT Male
Socket

Size	Steel
	Code
1/4	08-NH-200-20SM
3/8	08-NH-200-30SM
1/2	08-NH-200-40SM

Hi-Cupla One Touch 200 Series Combo packs.



Hose Size	Code
3/8	08-NC6K
1/2	08-NC8K

Code : 08-NCST1
Contents
5 x 20PM
2 x 20PF
2 x 200-20SM

Code : 08-NCST2
Contents
5 x 20PM
2 x 20PF
1 x 30PH
2 x 200-20SM
1 x 200-30SH
2 x O-Clips



Nut Cupla and Rotary Nut Cupla (For PU Tube)



SN
Nut
Socket

Tube Size	Steel
	Code
8x5 mm	08-NN-200-050SN
10x6.5 mm	08-NN-200-065SN
12x8 mm	08-NN-200-085SN
16x11 mm	08-NN-200-110SN



PN
Nut
Plug

Tube Size	Steel
	Code
8x5 mm	08-NN-050PN
10x6.5 mm	08-NN-065PN
12x8 mm	08-NN-085PN
16x11 mm	08-NN-110PN

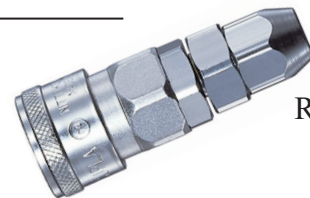

SNR
Rotary Nut
Socket

Equipped with ball bearing swivel

Tube Size	Steel
	Code
10x6.5 mm	08-NNR-65SNR
12x8 mm	08-NNR-85SNR



AIR COUPLERS (Category 8)

Lock Cupla (One Touch)



L-SF
BSP Female
Socket

Size	Steel	Stainless Steel
	Code	Code
1/4	08-NL-20SF	
3/8	08-NL-30SF	08-NLSS-30SF
1/2	08-NL-40SF	



L-SH
Hose
Socket

Size	Steel
	Code
1/4	08-NL-20SH
3/8	08-NL-30SH
1/2	08-NL-40SH



L-SM
BSPT Male
Socket

Size	Steel
	Code
1/4	08-NL-20SM
3/8	08-NL-30SM
1/2	08-NL-40SM

Purge Cuplas and Plugs

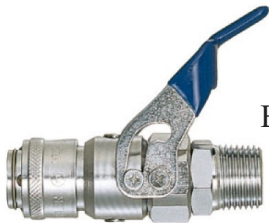

PV-SM
BSPT Male
Socket

Size	Steel
	Code
1/4	08-NPV-20SM
3/8	08-NPV-30SM
1/2	08-NPV-40SM



PV-PH Hose Plug

Size	Steel
	Code
1/4	08-NPV-20PH
3/8	08-NPV-30PH
1/2	08-NPV-40PH



PV-PN Nut Plug (For PU Tube)

Tube Size	Steel
	Code
10x6.5 mm	08-NPV-65PN
12x8 mm	08-NPV-85PN

Full Blow Cupla with Safety Lock and Purge Function



FB-SF
BSP Female
Socket

Size	Code
1/4	08-NFB-20SF
3/8	08-NFB-30SF
1/2	08-NFB-40SF



FB-SH
Hose Sock-
et

Size	Code
1/4	08-NFB-20SH
3/8	08-NFB-30SH
1/2	08-NFB-40SH



FB-SM
BSPT Male
Socket

Size	Code
1/4	08-NFB-20SM
3/8	08-NFB-30SM
1/2	08-NFB-40SM



FB-SN
Nut (PU Tube)
Socket

Tube Size	Code
10x6.5 mm	08-NFB-065SN
12x8 mm	08-NFB-085SN
16x11 mm	08-NFB-110SN



AIR COUPLERS (Category 8)

Rotary and Twist Plugs



45° Rotary Plug.
Swivels 360°

Thread	Code
1/4 BSPP Female	08-NRL-20PFF
1/4 BSPT Male	08-NRL-20PM
3/8 BSPT Male	08-NRL-30PM



Free Angle Twist Plug. Bend Angle 35°

Thread	Code
1/8 BSPT Male	08-NTS-10PM
1/4 BSPP Female	08-NTS-20PFF
1/4 BSPT Male	08-NTS-20PM
3/8 BSPT Male	08-NTS-30PM

Hi-Cupla Ace 250 (Plastic)



HA-SH
Hose
Socket

Size	Code
1/4	08-NP-HA-20SH
3/8	08-NP-HA-30SH



HA-SM
BSPT Male
Socket

Size	Code
1/4	08-NP-HA-20SM
3/8	08-NP-HA-30SM



HA-PFF
BSP Female
Plug

Size	Code
1/4	08-NP-HA-20PFF



HA-PH
Hose
Plug

Size	Code
3/8	08-NP-HA-30PH



HA-PM
BSPT
Male Plug

Size	Code
1/4	08-NP-HA-20PM
3/8	08-NP-HA-30PM



HA-PNG Nut Plug for PU Tube

Tube Size	Code
8x5 mm	08-NP-HA-50PNG
10x6.5 mm	08-NP-HA-65PNG
12x8 mm	08-NP-HA-85PNG



HA-SNG Nut Socket for PU Tube

Tube Size	Code
8x5 mm	08-NP-HA-50SNG
10x6.5 mm	08-NP-HA-65SNG
12x8 mm	08-NP-HA-85SNG

Duster Cupla (Dusts without removing the tool)



DCS-PH
Hose Sock-
et

Size	Code
1/4	08-NDCS-20PH
3/8	08-NDCS-30PH
1/2	08-NDCS-40PH



DCS-PN
PU Tube
Socket

Tube Size	Code
10x6.5 mm	08-NDCS-65PNG
12x8 mm	08-NDCS-85PNG



AIR COUPLERS (Category 8)

Large Bore Hi Cupla 100 Series

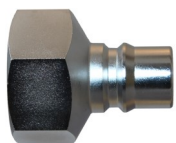

PF
BSP Female
Plug

	Steel	Brass	Stainless Steel
Size	Code	Code	Code
1/2	08-NHL-400PF	08-NHLB-400PF	08-NHLSS-400PF
3/4	08-NHL-600PF	08-NHLB-600PF	08-NHLSS-600PF
1"	08-NHL-800PF	08-NHLB-800PF	08-NHLSS-800PF



SF
BSP Female
Socket

	Steel	Brass	Stainless Steel
Size	Code	Code	Code
1/2	08-NHL-400SF	08-NHLB-400SF	08-NHLSS-400SF
3/4	08-NHL-600SF	08-NHLB-600SF	08-NHLSS-600SF
1"	08-NHL-800SF	08-NHLB-800SF	08-NHLSS-800SF



PH
Hose
Plug

	Steel	Brass	Stainless Steel
Size	Code	Code	Code
1/2	08-NHL-400PH	08-NHLB-400PH	08-NHLSS-400PH
3/4	08-NHL-600PH	08-NHLB-600PH	08-NHLSS-600PH
1"	08-NHL-800PH	08-NHLB-800PH	08-NHLSS-800PH



SH
Hose
Socket

	Steel	Brass	Stainless Steel
Size	Code	Code	Code
1/2	08-NHL-400SH	08-NHLB-400SH	08-NHLSS-400SH
3/4	08-NHL-600SH	08-NHLB-600SH	08-NHLSS-600SH
1"	08-NHL-800SH	08-NHLB-800SH	08-NHLSS-800SH



PM
BSPT Male
Plug

	Steel	Brass	Stainless Steel
Size	Code	Code	Code
1/2	08-NHL-400PM	08-NHLB-400PM	08-NHLSS-400PM
3/4	08-NHL-600PM	08-NHLB-600PM	08-NHLSS-600PM
1"	08-NHL-800PM	08-NHLB-800PM	08-NHLSS-800PM



SM
BSPT Male
Socket

	Steel	Brass	Stainless Steel
Size	Code	Code	Code
1/2	08-NHL-400SM	08-NHLB-400SM	08-NHLSS-400SM
3/4	08-NHL-600SM	08-NHLB-600SM	08-NHLSS-600SM
1"	08-NHL-800SM	08-NHLB-800SM	08-NHLSS-800SM

Seals for Large Bore Hi Cupla 100 Series



Code	Material	Temperature Rating
08-NHL-SN	Nitrile (Standard)	-20°C to +80°C
08-NHL-SV	Viton	-20°C to +180°C

Large Series Purge Cuplas

Size	Code
1/2	08-NPVL-400SM
3/4	08-NPVL-600SM

Dust Caps also available

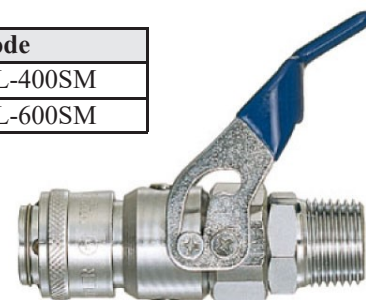



COUPLERS (Category 8)

PVR Cupla. Large series with Safety Lock and Purge Mechanism



PVR-SF
BSP Female
Socket

Size	Code
1/2	08-NPVR-400SF
3/4	08-NPVR-600SF
1"	08-NPVR-800SF



PVR-SH
Hose
Socket

Size	Code
1/2	08-NPVR-400SH
3/4	08-NPVR-600SH
1"	08-NPVR-800SH



PVR-SM
BSPT Male
Socket

Size	Code
1/2	08-NPVR-400SM
3/4	08-NPVR-600SM
1"	08-NPVR-800SM

Ball Lock Cupla. Large series

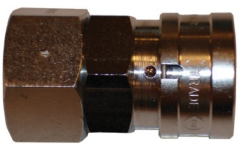

LL-SF
BSP Female
Socket

Size	Code
1/2	08-NLL-400SF
3/4	08-NLL-600SF
1"	08-NLL-800SF

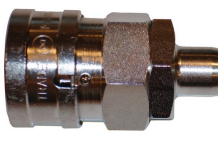

LL-SH
Hose Socket

Size	Code
1/2	08-NLL-400SH
3/4	08-NLL-600SH
1"	08-NLL-800SH



LL-SM
BSPT Male
Socket

Size	Code
1/2	08-NLL-400SM
3/4	08-NLL-600SM
1"	08-NLL-800SM

Micro Cupla



MC-PH
Hose
Plug

Size	Code
4mm	08-NM-MC04PH



MC-SH
Hose
Socket

Size	Code
4mm	08-NM-MC04SH



MC-SM
Male
Socket

Thread	Code
M5 x 0.8	08-NM-MC05SM
1/8 BSPT	08-NM-MC10SM

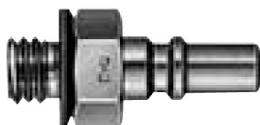

MC-PM
Male
Plug

Thread	Code
M5 x 0.8	08-NM-MC05PM
1/8 BSPT	08-NM-MC10PM



MC-SHB
Bulkhead
Hose Socket

Size	Code
4mm	08-NM-MC04SHB



MC-SHL
Hose Socket
Elbow

Size	Code
4mm	08-NM-MC04SHL



MC-PHL
Hose Plug
Elbow

Size	Code
4mm	08-NM-MC04PHL

- Material - Plated Brass
- Stainless Steel available in some sizes.
- Sleeve Outer Diameter confined to 9.5mm
- Max Working Pressure - 10 Bar (145 psi)
- Max Working Temperature - 80° C

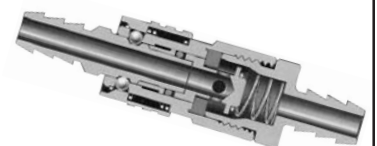



COUPLERS (Category 8)

Super Cupla



NS-PF
BSP Female
Plug

Size	Code
1/4	08-NS-02PFF



NS-PH
Hose
Plug

Size	Code
1/4	08-NS-02PH



NS-PM
BSPT
Male Plug

Size	Code
1/8	08-NS-01PM
1/4	08-NS-02PM



NS-PH
Nut
Plug

Tube Size	Code
8x5 mm	08-NS-01PN
10x6.5 mm	08-NS-02PN



NS-SF
BSP Female
Socket

Size	Code
1/4	08-NS-02SF



NS-SH
Hose
Socket

Size	Code
1/4	08-NS-02SH



NS-SM
BSPT Male
Socket

Size	Code
1/4	08-NS-02SM



NS-SN
Nut
Socket

Tube Size	Code
8x5 mm	08-NS-01SN
10x6.5 mm	08-NS-02SN

- Partly aluminium body for light weight
- Compact 19.5mm Sleeve O.D.
- Can connect to Nitto Khoki Mold Cuplas



Die Mold Cupla. Japanese Style



ND-PF
BSP Female
Plug

Size	Code
1/8	08-ND-K01PF
1/4	08-ND-K02PF
3/8	08-ND-K03PF



ND-PH
Hose
Plug

Size	Code
1/4	08-ND-K02PH
3/8	08-ND-K03PH



ND-PM
BSPT
Male Plug

Size	Code
1/8	08-ND-K01PM
1/4	08-ND-K02PM
3/8	08-ND-K03PM



ND-PML
BSPT Male
Elbow Plug

Size	Code
1/8	08-ND-K01PML
1/4	08-ND-K02PML
3/8	08-ND-K03PML



ND-SF
BSP Female
Socket

Size	Code
1/4	08-ND-K02SF



ND-SH
Hose
Socket

Size	Code
1/4	08-ND-K02SH
3/8	08-ND-K03SH



ND-SM
BSPT Male
Socket

Size	Code
1/4	08-ND-K02SM
3/8	08-ND-K03SM



ND-SHL
Hose Elbow
Socket

Size	Code
1/4	08-ND-K02SHL
3/8	08-ND-K03SHL

- Unvalved sockets available in some sizes
- Long sleeve socket facilitates connection / disconnection with plug embedded in mould.
- Space saving design for moulds with closely spaced coolant ports
- Max Working Pressure - 10 Bar (145 psi)
- Max Working Temp. - 80° C



COUPLERS (Category 8)

Mini Gas Cupla (For Oxy / Acetylene)

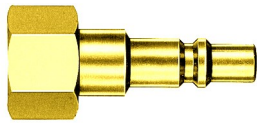

NG-PF
Female
Plug

Thread	Code	Usage
5/8 UNF R/H	08-NG-22PF	Oxygen
5/8 UNF L/H	08-NG-33PF	Acetylene



NG-SF
Female
Socket

Thread	Code	Usage
5/8 UNF R/H	08-NG-22SF	Oxygen
5/8 UNF L/H	08-NG-33SF	Acetylene



Packaged Sets	
Code	Contents
08-NGCF-22OXY	22PF + 22SF
08-NGCF-33ACET	33PF + 33SF



NG-PH
Hose
Plug

Size	Code	Usage
1/4	08-NG-22PH	Oxygen
1/4	08-NG-32PH	Acetylene



NG-SH
Hose
Socket

Size	Code	Usage
1/4	08-NG-22SH	Oxygen
1/4	08-NG-32SH	Acetylene



- Different coupling sizes prevent accidental connection of oxygen and acetylene
- Double lip seal prevents minor leaks during connection
- Pressure loss minimized for high flow rate.
- Temp Rating -20 to +80° C
- Max Working Pressure 100psi

TSP Cupla (Straight Through Japanese Series)



NT-PF
BSP Female
Plug

Size	Brass	Stainless Steel
	Code	Code
1/4	08-NT-2TPF	08-NTSS-2TPF
3/8	08-NT-3TPF	08-NTSS-3TPF
1/2	08-NT-4TPF	08-NTSS-4TPF
3/4	08-NT-6TPF	08-NTSS-6TPF
1"	08-NT-8TPF	08-NTSS-8TPF



NT-PM
BSPT Male
Plug

Size	Brass	Stainless Steel
	Code	Code
1/4	08-NT-2TPM	08-NTSS-2TPM
3/8	08-NT-3TPM	08-NTSS-3TPM
1/2	08-NT-4TPM	08-NTSS-4TPM
3/4	08-NT-6TPM	08-NTSS-6TPM
1"	08-NT-8TPM	08-NTSS-8TPM



NT-SF
BSP Female
Socket

Size	Brass	Stainless Steel
	Code	Code
1/4	08-NT-2TSF	08-NTSS-2TSF
3/8	08-NT-3TSF	08-NTSS-3TSF
1/2	08-NT-4TSF	08-NTSS-4TSF
3/4	08-NT-6TSF	08-NTSS-6TSF
1"	08-NT-8TSF	08-NTSS-8TSF



NT-PH
Hose
Plug

Size	Brass	Stainless Steel
	Code	Code
1/8	08-NT-1TPH	
1/4	08-NT-2TPH	08-NTSS-2TPH
3/8	08-NT-3TPH	08-NTSS-3TPH
1/2	08-NT-4TPH	08-NTSS-4TPH
3/4	08-NT-6TPH	08-NTSS-6TPH
1"	08-NT-8TPH	08-NTSS-8TPH



NT-SH
Hose
Socket

Size	Brass	Stainless Steel
	Code	Code
1/8	08-NT-1TSH	
1/4	08-NT-2TSH	08-NTSS-2TSH
3/8	08-NT-3TSH	08-NTSS-3TSH
1/2	08-NT-4TSH	08-NTSS-4TSH
3/4	08-NT-6TSH	08-NTSS-6TSH
1"	08-NT-8TSH	08-NTSS-8TSH



NT-SM
BSPT Male
Socket

Size	Brass	Stainless Steel
	Code	Code
1/8	08-NT-1TSM	
1/4	08-NT-2TSM	08-NTSS-2TSM
3/8	08-NT-3TSM	08-NTSS-3TSM
1/2	08-NT-4TSM	08-NTSS-4TSM
3/4	08-NT-6TSM	08-NTSS-6TSM
1"	08-NT-8TSM	08-NTSS-8TSM



COUPLERS (Category 8)

SP Cupla (Double Shut Off Japanese Series)



NSP-P
BSP Female
Plug

Size	Brass	Stainless Steel
	Code	Code
1/8	08-NSP-01P	08-NSPSS-01P
1/4	08-NSP-02P	08-NSPSS-02P
3/8	08-NSP-03P	08-NSPSS-03P
1/2	08-NSP-04P	08-NSPSS-04P
3/4	08-NSP-06P	08-NSPSS-06P
1"	08-NSP-08P	08-NSPSS-08P
1.1/4	08-NSP-10P	08-NSPSS-10P
1.1/2	08-NSP-12P	



NSP-S
BSP Female
Socket

Size	Brass	Stainless Steel
	Code	Code
1/8	08-NSP-01S	08-NSPSS-01S
1/4	08-NSP-02S	08-NSPSS-02S
3/8	08-NSP-03S	08-NSPSS-03S
1/2	08-NSP-04S	08-NSPSS-04S
3/4	08-NSP-06S	08-NSPSS-06S
1"	08-NSP-08S	08-NSPSS-08S
1.1/4	08-NSP-10S	08-NSPSS-10S
1.1/2	08-NSP-12S	

SP-V Cupla (Double Shut Off Series for Vacuum)

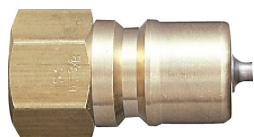

NSPV-P
BSP Female
Plug

Size	Brass
	Code
1/4	08-NSV-02P
3/8	08-NSV-03P
1/2	08-NSV-04P
3/4	08-NSV-06P



NSPV-S
BSP Female
Socket

Size	Brass
	Code
1/4	08-NSV-02S
3/8	08-NSV-03S
1/2	08-NSV-04S
3/4	08-NSV-06S

HSP Cupla (Hydraulic Cupla. Special steel body for vibration and Impact)



NHSP-HP
BSP Female
Plug

Size	Steel
	Code
1/4	08-NHSP-2HP
3/8	08-NHSP-3HP
1/2	08-NHSP-4HP
3/4	08-NHSP-6HP
1"	08-NHSP-8HP



NHSP-HS
BSP Female
Socket

Size	Steel
	Code
1/4	08-NHSP-2HS
3/8	08-NHSP-3HS
1/2	08-NHSP-4HS
3/4	08-NHSP-6HS
1"	08-NHSP-8HS

RYCO 200 INTERCHANGE COUPLERS (Category 8)



SR20F
BSP Female
Adaptor

	Brass	Steel
Size	Code	Code
1/4	08-SR20F4	08-SR20F4S
3/8	08-SR20F6	08-SR20F6S
1/2	08-SR20F8	



SR20M
BSPT Male
Adaptor

	Brass	Steel
Size	Code	Code
1/4	08-SR20M4	08-SR20M4S
3/8	08-SR20M6	08-SR20M6S
1/2	08-SR20M8	



SR200T
Hose
Coupling

	Brass	Steel
Size	Code	Code
1/4	08-SR200T4	
5/16	08-SR200T5	
3/8	08-SR200T6	08-SR200T6S
1/2	08-SR200T8	



SR20T
Hose
Adaptor

	Brass	Steel
Size	Code	Code
1/4	08-SR20T4	
5/16	08-SR20T5	
3/8	08-SR20T6	08-SR20T6S
1/2	08-SR20T8	



SR200F
BSP Female
Coupling

	Brass	Steel
Size	Code	Code
1/4	08-SR200F4	08-SR200F4S
3/8	08-SR200F6	
1/2	08-SR200F8	



SR200TWT
Twin Coupling

Code
08-SR200TWT



SR20TP
BSPT Swivel
Male
Adaptor

	Steel
Size	Code
1/4	08-SR20TP4



SR200M
BSPT Male
Coupling

	Brass	Steel
Size	Code	Code
1/4	08-SR200M4	08-SR200M4S
3/8	08-SR200M6	

- One Touch Connection
- Interchangeable with Ryco 200 and Pem F900 Series
- Will Pass approximately 60 CFM at 90 PSI

EURO / CEJN 320 INTERCHANGE COUPLERS (Category 8)



SR50F
BSP Female
Adaptor

Size	Code
1/4	08-SR50F4
3/8	08-SR50F6
1/2	08-SR50F8

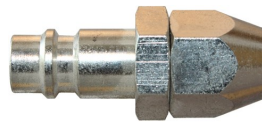

SR50P
PU Hose
Adaptor

Size	Code
8x5 mm	08-SR50P08
10x6.5 mm	08-SR50P10
12x8 mm	08-SR50P12



SR500M
BSPT Male
Coupling

Size	Code
1/4	08-SR500M4
3/8	08-SR500M6
1/2	08-SR500M8



SR50T
Hose
Adaptor

Size	Code
1/4	08-SR50T4
5/16	08-SR50T5
3/8	08-SR50T6
1/2	08-SR50T8



SR500F
BSP Female
Coupling

Size	Code
1/4	08-SR500F4
3/8	08-SR500F6
1/2	08-SR500F8



SR500P
PU Hose
Coupling

Size	Code
8x5 mm	08-SR500P08
10x6.5 mm	08-SR500P10
12x8 mm	08-SR500P12

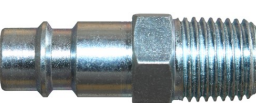

SR50M
BSPT Male
Adaptor

Size	Code
1/4	08-SR50M4
3/8	08-SR50M6
1/2	08-SR50M8



SR500T
Hose
Coupling

Size	Code
1/4	08-SR500T4
5/16	08-SR500T5
3/8	08-SR500T6
1/2	08-SR500T8

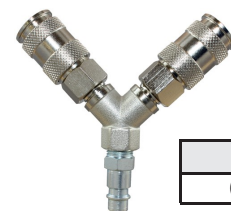

SR500TWT
Twin Coupling

Code
08-SR500TWT

- Interchangeable with CEJN 230, Euro and Ryco 500 Series.
- Nickel plated steel construction

RYCO AIR COUPLERS (Category 8)

Ryco 200 Series

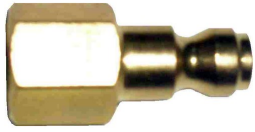

R20F
BSP Female
Adaptor

	Brass	Steel
Size	Code	Code
1/8	08-R20F2	
1/4	08-R20F4	08-R20F4S
3/8		08-R20F6S
Schrader	08-R20SHF	

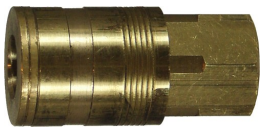

R200F
BSP Female
Coupling

	Brass	Steel
Size	Code	Code
1/4	08-R200F4	08-R200F4S
3/8	08-R200F6	08-R200F6S
1/2	08-R200F8	



R20M
BSPT Male
Adaptor

	Brass	Steel
Size	Code	Code
1/8	08-R20M2	
1/4	08-R20M4	08-R20M4S
3/8	08-R20M6	08-R20M6S
1/2		08-R20M8S



R200M
BSPT Male
Coupling

	Brass	Steel
Size	Code	Code
1/4	08-R200M4	08-R200M4S
3/8	08-R200M6	08-R200M6S

Will pass approx 45CFM at 90psi



R20T
Hose
Adaptor

	Brass	Steel
Size	Code	Code
3/16	08-R20T3	
1/4	08-R20T4	08-R20T4S
5/16	08-R20T5	08-R20T5S
3/8	08-R20T6	08-R20T6S
1/2	08-R20T8	08-R20T8S



R200T
Hose
Coupling

	Brass	Steel
Size	Code	Code
1/4	08-R200T4	
5/16	08-R200T5	08-R200T5S
3/8	08-R200T6	08-R200T6S
1/2	08-R200T8	

Ryco 290 Series



R290F
BSP Female
Coupling

Size	Code
1/4	08-R290F4
3/8	08-R290F6
1/2	08-R290F8



R290M
BSPT Male
Coupling

Size	Code
1/4	08-R290M4
3/8	08-R290M6
1/2	08-R290M8



R290T
Hose
Coupling

Size	Code
1/4	08-R290T4
5/16	08-R290T5
3/8	08-R290T6
1/2	08-R290T8

- Will pass approx 90 CFM at 90psi.
- Nickel Plated Steel Construction.
- One Touch Connection
- Connects with R200 Series Adaptors.

Ryco 300 Series

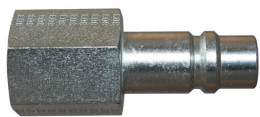

R30F
BSP Female
Adaptor

Size	Code
3/8	08-R30F6
1/2	08-R30F8



R30M
BSPT Male
Adaptor

Size	Code
1/4	08-R30M4
3/8	08-R30M6
1/2	08-R30M8



R30T
Hose
Adaptor

Size	Code
3/8	08-R30T6
1/2	08-R30T8



R300F
BSP Female
Coupling

Size	Code
3/8	08-R300F6
1/2	08-R300F8



R300M
BSPT Male
Coupling

Size	Code
3/8	08-R300M6
1/2	08-R300M8



R300T
Hose
Coupling

Size	Code
1/2	08-R300T8

Will pass approx 165CFM at 90psi
Nickel Plated Steel Construction

CAMOZZI MINI COUPLERS

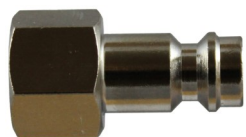

C5350
BSP Female
Adaptor

Size	Code
1/8	08-C5350-02
1/4	08-C5350-04



C5150
BSP Male
Adaptor

Size	Code
1/8	08-C5150-02
1/4	08-C5150-04

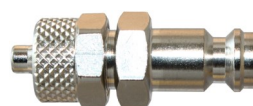

C5450
Rapid Tube
Adaptor

Size	Code
6x4 mm	08-C5450-06
8x6 mm	08-C5450-08



C5650
Hose
Adaptor

Size	Code
6 mm	08-C5650-06
9 mm	08-C5650-09

C5850 Rapid Tube Adaptor
with Spring



Size	Code
6x4 mm	08-C5850-06
8x6 mm	08-C5850-08



C5053
BSP Female
Coupling

Size	Code
1/8	08-C5053-02
1/4	08-C5053-04



C5051
BSP Male
Coupling

Size	Code
1/8	08-C5051-02
1/4	08-C5051-04

C5052
BSP Male Bulkhead Coupling



Size	Code
1/8	08-C5052-02
1/4	08-C5052-04



C5054
Rapid Tube
Coupling

Size	Code
6x4 mm	08-C5054-06
8x6 mm	08-C5054-08

C5055
Rapid Tube Bulkhead Coupling



Size	Code
6x4 mm	08-C5055-06
8x6 mm	08-C5055-08

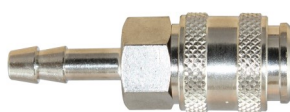

C5056
Hose
Coupling

Size	Code
6 mm	08-C5056-06
9 mm	08-C5056-09

C5058 Rapid Tube Coupling
with Spring



Size	Code
6x4 mm	08-C5058-06

RECTUS33 / ATLAS COPCO QIC10 COUPLERS



AC10AF
BSP Female
Adaptor

Size	Code
1/4	08-AC10AF4

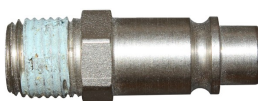

AC10AM
BSPT Male
Adaptor

Size	Code
1/4	08-AC10AM4



AC10AT
Hose
Adaptor

Size	Code
3/8	08-AC10AT6
1/2	08-AC10AT8



AC10CF
BSP Female
Coupling

Size	Code
1/4	08-AC10CF4
1/2	08-AC10CF8



AC10CT
Hose
Coupling

Size	Code
3/8	08-AC10CT6
1/2	08-AC10CT8



AC10CM
BSPT Male
Coupling

Size	Code
1/4	08-AC10CM4

US INDUSTRIAL INTERCHANGE COUPLERS



Female Adaptor

Body Size	Thread	Brass	Steel
		Code	Code
1/4	1/4 NPT	08-P24F4	08-P24F4S
3/8	1/4 NPT		08-P26F4S



Female Coupling

Body Size	Thread	Brass	Steel
		Code	Code
1/4	1/4 NPT	08-P240F4	
3/8	1/4 NPT		08-P260F4S
3/8	3/8 NPT		08-P260F6S



Male Adaptor

Body Size	Thread	Brass	Steel
		Code	Code
1/4	1/4 NPT	08-P24M4	08-P24M4S
1/4	1/4 BSPT	08-P24M4B	
3/8	1/4 NPT		08-P26M4S
3/8	3/8 NPT		08-P26M6S
3/8	1/2 NPT		08-P26M8S



Male Coupling

Body Size	Thread	Brass	Steel
		Code	Code
1/4	1/4 NPT	08-P240M4	
1/4	1/4 BSPT	08-P240M4B	
3/8	1/4 NPT		08-P260M4S
3/8	3/8 NPT		08-P260M6S
3/8	1/2 NPT		08-P260M8S



Hose Adaptor

Body Size	Hose ID	Steel
		Code
1/4	1/4	08-P24T4S
1/4	3/8	08-P24T6S
3/8	3/8	08-P26T6S



Hose Coupling

Body Size	Hose ID	Brass	Steel
		Code	Code
1/4	1/4	08-P240T4	
1/4	3/8	08-P240T6	
3/8	3/8		08-P260T6S
3/8	1/2		08-P260T8S

ISO B DOUBLE SHUT OFF COUPLERS



Female Adaptor

Thread	Brass
	Code
1/8 NPT	08-PBH1-61
1/4 NPT	08-PBH2-61-493
3/8 NPT	08-PBH3-61
1/2 NPT	08-PBH4-61
3/4 NPT	08-PBH6-61
1" NPT	08-PBH8-61



Female Coupling

Thread	Brass
	Code
1/8 NPT	08-PBH1-60
1/4 NPT	08-PBH2-60-493
3/8 NPT	08-PBH3-60
1/2 NPT	08-PBH4-60
3/4 NPT	08-PBH6-60
1" NPT	08-PBH8-60

Note : 1/4 NPT sizes listed above have Stainless Steel internals suitable for steam cleaner applications.

ISO B couplers are also available in steel and stainless steel. BSP threads are also available and dust plugs and caps. Please contact the sales office for further details

PLASTIC INJECTION MOULDING COUPLERS

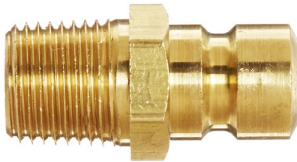

Male Adaptor

		Brass
Body Size	Thread	Code
1/4	1/8 BSPT	08-PN4-02
1/4	1/4 BSPT	08-PN4-04
1/4	1/8 NPT	08-PN4-N02
1/4	1/4 NPT	08-PN4-N04
1/4	3/8 NPT	08-PN4-N06
3/8	1/4 BSPT	08-PN6-04
3/8	3/8 BSPT	08-PN6-06
3/8	1/4 NPT	08-PN6-N04
3/8	3/8 NPT	08-PN6-N06
3/8	1/2 NPT	08-PN6-N08
1/2	1/2 NPT	08-PN8-N08
1/2	3/4 NPT	08-PN8-N12



Female Adaptor

		Steel
Body Size	Thread	Code
1/4	1/8 NPT	08-PN4-N02F
1/4	1/4 NPT	08-PN4-N04F
3/8	1/4 NPT	08-PN6-N04F
3/8	1/2 NPT	08-PN6-N08F



Hose Coupler

		Brass Unvalved	Brass Valved
Body Size	Hose ID	Code	Code
1/4	1/4	08-PC4-H04	08-PC4V-H04
1/4	5/16	08-PC4-H05	08-PC4V-H05
1/4	3/8	08-PC4-H06	08-PC4V-H06
3/8	3/8	08-PC6-H06	08-PC6V-H06
3/8	1/2	08-PC6-H08	08-PC6V-H08
1/2	1/2	08-PC8-H08	08-PC8V-H08
1/2	3/4	08-PC8-H12	08-PC8V-H12

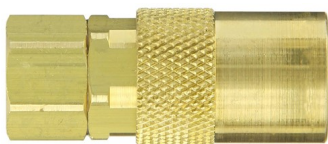

Female Coupler

		Brass Unvalved	Brass Valved
Body Size	Thread	Code	Code
1/4	1/8 BSPT	08-PC4-02	
3/8	1/4 NPT	08-PC6-N04	08-PC6V-N04
1/2	1/2 NPT	08-PC8-N08	

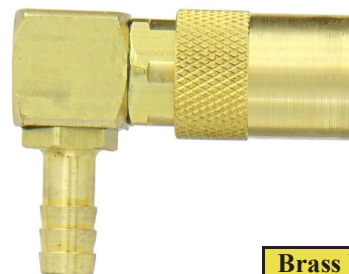

90° Hose Coupler

		Brass Unvalved	Brass Valved
Body Size	Hose ID	Code	Code
1/4	1/4	08-PC4-H0490	08-PC4V-H0490
1/4	3/8	08-PC4-H0690	08-PC4V-H0690
3/8	3/8	08-PC6-H0690	08-PC6V-H0690
3/8	1/2	08-PC6-H0890	08-PC6V-H0890

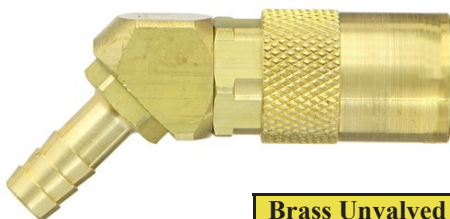

45° Hose Coupler

		Brass Unvalved	Brass Valved
Body Size	Hose ID	Code	Code
1/4	1/4	08-PC4-H0445	08-PC4V-H0445
1/4	3/8	08-PC4-H0645	08-PC4V-H0645
3/8	3/8	08-PC6-H0645	08-PC6V-H0645
3/8	1/2	08-PC6-H0845	08-PC6V-H0845

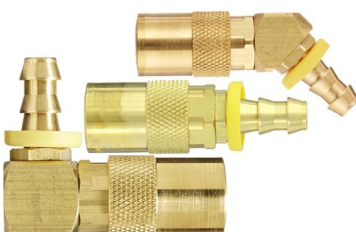

Some sizes available with Pushlok Tails.
Please contact the sales office for further details



Replacement Seal

Body Size	Material	Colour	Code
3/8	Silicon	Red	08-PC6-SS

TEMA[®] Genuine

T Series Couplers



- Manually operated locking sleeve prevents unintended disconnection
- Double 'O' Ring sealing
- Nitrile seals (Viton seals also available)
- Unvalved options for full flow
- Stainless steel types available
- Other sizes also available on request

Female Thread	Working Pressure Connected	Working Pressure Disconnected	Adaptor Code	Coupling Code	Adaptor Plug	Coupling Plug	Coupling Seal Kit
1/8 BSPP	200 Bar	100 Bar	08-T2320	08-T2310			
1/4 BSPP	450 Bar	300 Bar	08-T2520	08-T2510	08-T2526	08-T2516	08-T2500PSN
3/8 BSPP	350 Bar	280 Bar	08-T3820	08-T3810	08-T3826	08-T3816	08-T3800PSN
1/2 BSPP	300 Bar	250 Bar	08-T5020	08-T5010	08-T5026	08-T5016	08-T5000PSN
3/4 BSPP	280 Bar	200 Bar	08-T7520	08-T7510	08-T7526	08-T7516	08-T7500PSN
1" BSPP	250 Bar	200 Bar	08-T10020	08-T10010	08-T10026	08-T10016	08-T10000PSN

Materials

Coupling

Coupling Body Sleeve	Brass, Nickel Plated, Chromated Steel hardened, Zinc Plated, Yellow passivated
Locking Ring	Brass, Zinc-iron coated, Black passivated
Valve Springs	Brass
Locking Balls	AISI 301
Seals	AISI 420 C
Valve Holder	NBR/FKM
	Brass

Plug

Plug Body	Steel, hardened, Zinc Plated, Yellow passivated
Valve Springs	Brass
Seals	AISI 301
Valve Holder	NBR/FKM
	Brass

The Tema couplings offer an absolute dry break - no oil loss during uncoupling.

Due to the valve construction the Tema coupling has minimal pressure drop. It also features a safety locking device to prevent unintentional uncoupling.

Both coupling and Adaptor feature a shut off valve. A safety closing ring prevents accidental disconnection.

Large flow rate makes the Tema coupling ideal for elevating machinery. Also used in the Chemical industry, off-shore, deep sea and materials handling

Working Temperature: -40°C to +100°C

AGA approval N° 4444

TEMA[®] Dive Couplers

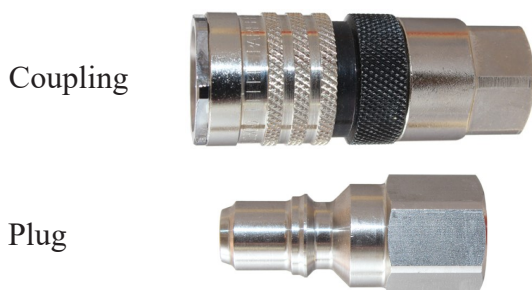

Code	Female
08-T2510ELRF	1/4 BSPP

Code	Female
08-T2520RF	1/4 BSPP

The Tema 2500 Series is specifically designed for the diving industry.

The coupler comprises of a safety locking ring to prevent accidental uncoupling

The 2520RF Adapter is manufactured from stainless steel.

CEJN Breathing Air Couplings

341 Series for Wet or Salty Conditions. (Nickel Plated Brass)



BSP Female Adaptor

Size	Code
1/4	08-C341-AF4
3/8	08-C341-AF6
1/2	08-C341-AF8

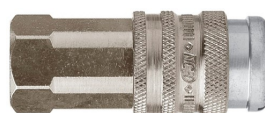

BSP Female Coupling

Size	Code
1/4	08-C341-CF4
3/8	08-C341-CF6



BSPT Male Adaptor

Size	Code
1/4	08-C341-AM4
3/8	08-C341-AM6
1/2	08-C341-AM8



BSPT Male Coupler

Size	Code
1/4	08-C341-CM4
3/8	08-C341-CM6
1/2	08-C341-CM8



Hose Adaptor

Size	Code
1/4	08-C341-AT4
5/16	08-C341-AT5
3/8	08-C341-AT6
1/2	08-C341-AT8



Hose Coupler

Size	Code
1/4	08-C341-CT4
5/16	08-C341-CT5
3/8	08-C341-CT6
1/2	08-C341-CT8

342 Series for Dry Conditions. (Zinc Plated Steel)

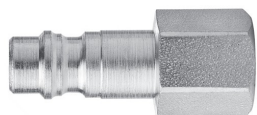

BSP Female Adaptor

Size	Code
1/4	08-C342-AF4
3/8	08-C342-AF6

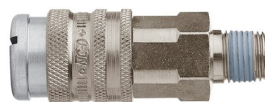

BSPT Male Coupler

Size	Code
1/4	08-C342-CM4
3/8	08-C342-CM6
1/2	08-C342-CM8

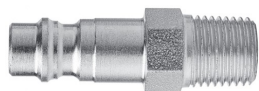

BSPT Male Adaptor

Size	Code
1/4	08-C342-AM4
3/8	08-C342-AM6
1/2	08-C342-AM8

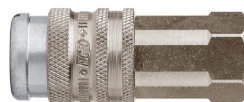

BSP Female Coupling

Size	Code
1/4	08-C342-CF4
3/8	08-C342-CF6
1/2	08-C342-CF8



Hose Adaptor

Size	Code
1/4	08-C342-AT4
3/8	08-C342-AT6
1/2	08-C342-AT8



Hose Coupler

Size	Code
1/4	08-C342-CT4
5/16	08-C342-CT5
3/8	08-C342-CT6
1/2	08-C342-CT8

ARS Quick Couplings

ARS 178 Series (Stainless Steel)

- Ball Type Straight Through Coupler typically used in the food industry.
- Rated Pressure : 250 bar (3650psi)
- Flow Rate : 50 l/min
- Max Temp : 90° C
- Viton Seals
- Internal Passage : 12mm



BSP Female Adaptor

Size	Code
1/4	08-ARS178-AF4
3/8	08-ARS178-AF6
1/2	08-ARS178-AF8



BSP Male Adaptor

Size	Code
1/2	08-ARS178-AM8



BSP Female Coupling

Size	Code
3/8	08-ARS178-CF6
1/2	08-ARS178-CF8



BSP Male Coupling

Size	Code
1/2	08-ARS178-CM8

ARS 250 Series (Nickel Plated Brass coupler / Nickel Plated Steel Adaptor)

- Ball Type Straight Through Coupler typically used in the high pressure water applications like pressure washers and car washes.
- Rated Pressure : 250 bar (3650psi)
- Flow Rate : 30 l/min
- Max Temp : 90° C
- NBR Seals
- Internal Passage : 8.5mm



BSP Female Adaptor

Size	Code
1/4	08-ARS250-AF4
3/8	08-ARS250-AF6



BSP Male Adaptor

Size	Code
3/8	08-ARS250-AM6
1/2	08-ARS250-AM8



BSP Female Coupling

Size	Code
1/4	08-ARS250-CF4
3/8	08-ARS250-CF6
1/2	08-ARS250-CF8



BSP Male Coupling

Size	Code
3/8	08-ARS250-CM6

4 Piece 1/2 (12mm) Brass Garden Hose Fitting Set



Code
08-BGHKIT



1/2 BSP Female Adaptor to connect thread on 40-HQR1020 hose reel to garden hose fittings.



Code
08-BGHA



TEFEN ACETAL TUBE FITTINGS (Category 9)



#1N
Spacer Set

Code	Size
09-001-08	1/2



#2N
Tube Nut

Code	Tube
09-002-03	3/16
09-002-04	1/4
09-002-05	5/16
09-002-06	3/8
09-002-08	1/2



#3N
Male
Connector

Code	Tube	BSP
09-003-0304	3/16	1/4
09-003-0402	1/4	1/8
09-003-0504	5/16	1/4
09-003-0806	1/2	3/8
09-303-0402	4mm	1/8
09-303-0404	4mm	1/4
09-303-0602	6mm	1/8
09-303-0604	6mm	1/4
09-303-1206	12mm	3/8
09-303-1208	12mm	1/2



#4N
Double
Union

Code	Tube
09-004-03	3/16
09-004-08	1/2
09-304-06	6mm
09-304-12	12mm



#4RN
Reducing
Union

Code	Tube	Tube
09-004R-0604	3/8	1/4
09-004R-0605	3/8	5/16
09-004R-0806	1/2	3/8



#5N
Male Elbow
Connector

Code	Tube	BSP
09-005-0302	3/16	1/8
09-005-0502	5/16	1/8
09-005-0504	5/16	1/4
09-005-0606	3/8	3/8
09-005-0806	1/2	3/8
09-005-0808	1/2	1/2
09-305-0402	4mm	1/8
09-305-0404	4mm	1/4
09-305-0602	6mm	1/8
09-305-1004	10mm	1/4
09-305-1006	10mm	3/8
09-305-1206	12mm	3/8
09-305-1208	12mm	1/2



#10N
Female
Connector

Code	Tube	BSP
09-010-0304	3/16	1/4
09-010-0402	1/4	1/8
09-010-0404	1/4	1/4
09-010-0502	5/16	1/8
09-010-0504	5/16	1/4
09-010-0604	3/8	1/4
09-010-0606	3/8	3/8
09-010-0808	1/2	1/2
09-310-0602	6mm	1/8



#11N
Union
Elbow

Code	Tube
09-011-05	5/16
09-011-06	3/8
09-011-08	1/2
09-311-06	6mm



#12N
Male Branch
Tee

Code	Tube	BSP
09-012-0402	1/4	1/8
09-012-0502	5/16	1/8
09-012-0604	3/8	1/4
09-012-0606	3/8	3/8
09-012-0806	1/2	3/8
09-012-0808	1/2	1/2
09-312-0402	4mm	1/8
09-312-0404	4mm	1/4



#13N
Male Run
Tee

Code	Tube	BSP
09-013-0806	1/2	3/8
09-013-0808	1/2	1/2



#14N
Union Tee

Code	Tube
09-014-04	1/4
09-014-05	5/16
09-014-06	3/8
09-314-06	6mm
09-314-12	12mm

NYLON SCREWED FITTINGS (Category 9)



#24N
Reducing
Bush

Code	Male	Female	Colour
09-024-0402	1/4 BSPT	1/8 BSP	Blue
09-024-0602	3/8 BSPT	1/8 BSP	Blue
09-024-0604	3/8 BSPT	1/4 BSP	Blue
09-024-0802	1/2 BSPT	1/8 BSP	Blue
09-024-0804	1/2 BSPT	1/4 BSP	Black
09-024-0806	1/2 BSPT	3/8 BSP	Black
09-024-1204	3/4 BSPT	1/4 BSP	Black
09-024-1206	3/4 BSPT	3/8 BSP	Blue
09-024-1208	3/4 BSPT	1/2 BSP	Black
09-024-1604	1" BSPT	1/4 BSP	Black
09-024-1606	1" BSPT	3/8 BSP	Black
09-024-1608	1" BSPT	1/2 BSP	Black
09-024-1612	1" BSPT	3/4 BSP	Black
09-024-2008	1.1/4 BSPT	1/2 BSP	Black
09-024-2012	1.1/4 BSPT	3/4 BSP	Black
09-024-2016	1.1/4 BSPT	1" BSP	Black
09-024-2408	1.1/2 BSPT	1/2 BSP	Black
09-024-2412	1.1/2 BSPT	3/4 BSP	Black
09-024-2416	1.1/2 BSPT	1" BSP	Black
09-024-2420	1.1/2 BSPT	1.1/4 BSP	Black
09-024-3208	2" BSPT	1/2 BSP	Black
09-024-3212	2" BSPT	3/4 BSP	Black
09-024-3216	2" BSPT	1" BSP	Black
09-024-3220	2" BSPT	1.1/4 BSP	Black
09-024-3224	2" BSPT	1.1/2 BSP	Black
09-024-4020	2.1/2 BSPT	1.1/4 BSP	Black
09-024-4024	2.1/2 BSPT	1.1/2 BSP	Black
09-024-4032	2.1/2 BSPT	2" BSP	Black
09-024-4824	3" BSPT	1.1/2 BSP	Black
09-024-4832	3" BSPT	2" BSP	Black
09-024-4840	3" BSPT	2.1/2 BSP	Black
09-024-6432	4" BSPT	2" BSP	Black
09-024-6440	4" BSPT	2.1/2 BSP	Black
09-024-6448	4" BSPT	3" BSP	Black



#25N
M&F
Elbow

Code	Male	Female	Colour
09-025-08	1/2 BSPT	1/2 BSP	Black
09-025-12	3/4 BSPT	3/4 BSP	Black
09-025-16	1" BSPT	1" BSP	Black
09-025-20	1.1/4 BSPT	1.1/4 BSP	Black
09-025-24	1.1/2 BSPT	1.1/2 BSP	Black
09-025-32	2" BSPT	2" BSP	Black

Note : Colours listed are correct at the time of publication, but are subject to change



#26N
Socket

Code	Female	Colour
09-026-02	1/8 BSP	Blue
09-026-04	1/4 BSP	Blue
09-026-06	3/8 BSP	Blue
09-026-08	1/2 BSP	Black
09-026-12	3/4 BSP	Black
09-026-16	1" BSP	Black
09-026-20	1.1/4 BSP	Black
09-026-24	1.1/2 BSP	Black
09-026-32	2" BSP	Black
09-026-40	2.1/2 BSP	Black
09-026-48	3" BSP	Black
09-026-64	4" BSP	Black

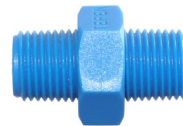

#27N
Hex
Nipple

Code	Male	Colour
09-027-02	1/8 BSPT	Blue
09-027-04	1/4 BSPT	Black
09-027-06	3/8 BSPT	Black
09-027-08	1/2 BSPT	Black
09-027-12	3/4 BSPT	Black
09-027-16	1" BSPT	Black
09-027-20	1.1/4 BSPT	Black
09-027-24	1.1/2 BSPT	Black
09-027-32	2" BSPT	Black
09-027-40	2.1/2 BSPT	Black
09-027-48	3" BSPT	Black
09-027-64	4" BSPT	Black



#33N
Hex
Cap

Code	Female	Colour
09-033-02	1/8 BSP	Blue
09-033-04	1/4 BSP	Blue
09-033-06	3/8 BSP	Blue
09-033-08	1/2 BSP	Blue
09-033-12	3/4 BSP	Blue
09-033-16	1" BSP	Black
09-033-20	1.1/4 BSP	Black
09-033-24	1.1/2 BSP	Black
09-033-32	2" BSP	Black
09-033-40	2.1/2 BSP	Black
09-033-48	3" BSP	Black
09-033-64	4" BSP	Black

NYLON SCREWED FITTINGS (Category 9)



#29N
Reducing
Socket

Code	Female	Female	Colour
09-029-0402	1/4 BSP	1/8 BSP	Blue
09-029-0602	3/8 BSP	1/8 BSP	Blue
09-029-0604	3/8 BSP	1/4 BSP	Blue
09-029-0804	1/2 BSP	1/4 BSP	Blue
09-029-0806	1/2 BSP	3/8 BSP	Blue
09-029-1208	3/4 BSP	1/2 BSP	Black
09-029-1608	1" BSP	1/2 BSP	Black
09-029-1612	1" BSP	3/4 BSP	Black
09-029-2012	1.1/4 BSP	3/4 BSP	Black
09-029-2016	1.1/4 BSP	1" BSP	Black
09-029-2412	1.1/2 BSP	3/4 BSP	Black
09-029-2416	1.1/2 BSP	1" BSP	Black
09-029-2420	1.1/2 BSP	1.1/4 BSP	Black
09-029-3212	2" BSP	3/4 BSP	Black
09-029-3216	2" BSP	1" BSP	Black
09-029-3220	2" BSP	1.1/4 BSP	Black
09-029-3224	2" BSP	1.1/2 BSP	Black
09-029-4024	2.1/2 BSP	1.1/2 BSP	Black
09-029-4032	2.1/2 BSP	2" BSP	Black
09-029-4832	3" BSP	2" BSP	Black
09-029-4840	3" BSP	2.1/2 BSP	Black
09-029-6440	4" BSP	2.1/2 BSP	Black
09-029-6448	4" BSP	3" BSP	Black



#34N
F&F
Elbow

Code	Female	Colour
09-034-08	1/2 BSP	Black
09-034-12	3/4 BSP	Black
09-034-16	1" BSP	Black
09-034-20	1.1/4 BSP	Black
09-034-24	1.1/2 BSP	Black
09-034-32	2" BSP	Black
09-034-40	2.1/2 BSP	Black
09-034-48	3" BSP	Black
09-034-64	4" BSP	Black



#35MN
Male Tee

Code	Male	Colour
09-035M-02	1/8 BSPT	Blue
09-035M-04	1/4 BSPT	Blue
09-035M-06	3/8 BSPT	Blue
09-035M-08	1/2 BSPT	Blue



#35N
Female
Tee

Code	Female	Colour
09-035-08	1/2 BSP	Black
09-035-12	3/4 BSP	Black
09-035-16	1" BSP	Black
09-035-20	1.1/4 BSP	Black
09-035-24	1.1/2 BSP	Black
09-035-32	2" BSP	Black
09-035-40	2.1/2 BSP	Black
09-035-48	3" BSP	Black
09-035-64	4" BSP	Black

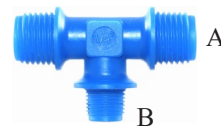

#35MRN
Male Branch
Reducing Tee

Code	Male A	Male B	Colour
09-035MR-0204	1/8 BSPT	1/4 BSPT	Blue
09-035MR-0402	1/4 BSPT	1/8 BSPT	Blue



#48N
Male
Elbow

Code	Male	Colour
09-048-04	1/4 BSPT	Blue
09-048-06	3/8 BSPT	Blue
09-048-08	1/2 BSPT	Blue



#48RN
Reducing
Male Elbow

Code	Male	Male	Colour
09-048R-0402	1/4 BSPT	1/8 BSPT	Blue



#64N
Hex
Plug

Code	Male	Colour
09-064-02	1/8 BSPT	Black
09-064-04	1/4 BSPT	Black
09-064-06	3/8 BSPT	Black
09-064-08	1/2 BSPT	Black
09-064-12	3/4 BSPT	Black
09-064-16	1" BSPT	Black
09-064-20	1.1/4 BSPT	Black
09-064-24	1.1/2 BSPT	Black
09-064-32	2" BSPT	Black
09-064-40	2.1/2 BSPT	Black
09-064-48	3" BSPT	Black
09-064-64	4" BSPT	Black

Note : Colours listed are correct at the time of publication, but are subject to change

NYLON SCREWED FITTINGS (Category 9)



#72N
M&F
Adaptor

Code	Female	Male	Colour
09-072-0202	1/8 BSP	1/8 BSPT	Blue
09-072-0402	1/4 BSP	1/8 BSPT	Blue
09-072-0404	1/4 BSP	1/4 BSPT	Blue
09-072-0602	3/8 BSP	1/8 BSPT	Blue
09-072-0604	3/8 BSP	1/4 BSPT	Blue
09-072-0606	3/8 BSP	3/8 BSPT	Blue
09-072-0802	1/2 BSP	1/8 BSPT	Blue
09-072-0804	1/2 BSP	1/4 BSPT	Blue
09-072-0806	1/2 BSP	3/8 BSPT	Blue
09-072-0808	1/2 BSP	1/2 BSPT	Blue



#73N
Reducing
Nipple

Code	Male	Male	Colour
09-073-0402	1/4 BSPT	1/8 BSPT	Blue
09-073-0602	3/8 BSPT	1/8 BSPT	Blue
09-073-0604	3/8 BSPT	1/4 BSPT	Blue
09-073-0802	1/2 BSPT	1/8 BSPT	Black
09-073-0804	1/2 BSPT	1/4 BSPT	Black
09-073-0806	1/2 BSPT	3/8 BSPT	Black
09-073-1206	3/4 BSPT	3/8 BSPT	Black
09-073-1208	3/4 BSPT	1/2 BSPT	Black
09-073-1608	1" BSPT	1/2 BSPT	Black
09-073-1612	1" BSPT	3/4 BSPT	Black
09-073-2012	1.1/4 BSPT	3/4 BSPT	Black
09-073-2016	1.1/4 BSPT	1" BSPT	Black
09-073-2412	1.1/2 BSPT	3/4 BSPT	Black
09-073-2416	1.1/2 BSPT	1" BSPT	Black
09-073-2420	1.1/2 BSPT	1.1/4 BSPT	Black
09-073-3212	2" BSPT	3/4 BSPT	Black
09-073-3216	2" BSPT	1" BSPT	Black
09-073-3220	2" BSPT	1.1/4 BSPT	Black
09-073-3224	2" BSPT	1.1/2 BSPT	Black
09-073-4020	2.1/2 BSPT	1.1/4 BSPT	Black
09-073-4024	2.1/2 BSPT	1.1/2 BSPT	Black
09-073-4032	2.1/2 BSPT	2" BSPT	Black
09-073-4824	3" BSPT	1.1/2 BSPT	Black
09-073-4832	3" BSPT	2" BSPT	Black
09-073-4840	3" BSPT	2.1/2 BSPT	Black
09-073-6432	4" BSPT	2" BSPT	Black
09-073-6440	4" BSPT	2.1/2 BSPT	Black
09-073-6448	4" BSPT	3" BSPT	Black

Note : Colours listed are correct at the time of publication, but are subject to change



#74FN
Flanged
Locknut

Code	Female	Colour
09-074F-08	1/2 BSP	Black
09-074F-12	3/4 BSP	Black
09-074F-16	1" BSP	Black
09-074F-20	1.1/4 BSP	Black
09-074F-24	1.1/2 BSP	Black
09-074F-32	2" BSP	Black



#85N
Barrel
Union

Code	Female	Colour
09-085-12	3/4 BSP	Black
09-085-16	1" BSP	Black
09-085-20	1.1/4 BSP	Black
09-085-24	1.1/2 BSP	Black
09-085-32	2" BSP	Black



Nylon
M&F Skin
Fitting

Code	Female	Male	Colour
09-SK08	1/2 BSP	1/2 BSP	Black
09-SK12	3/4 BSP	3/4 BSP	Black
09-SK16	1" BSP	1" BSP	Black
09-SK20	1.1/4 BSP	1.1/4 BSP	Black
09-SK24	1.1/2 BSP	1.1/2 BSP	Black
09-SK32	2" BSP	2" BSP	Black

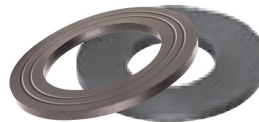

Spare
Washers

Size	Black Rubber Sealing Washer	Black Poly Slip Washer
1/2	09-WR08	09-WS08
3/4	09-WR12	09-WS12
1"	09-WR16	09-WS16
1.1/4	09-WR20	09-WS20
1.1/2	09-WR24	09-WS24
2"	09-WR32	09-WS32

Also Available :

- Polypropylene Screwed Fittings.
- Polypropylene Hose Tails.
- Polypropylene Tube Fittings.
- PVC Ball Valves
- Plastic Quick Couplers.
- Polypropylene Camlocks.

NYLON HOSE FITTINGS (Category 9)



P3N
Male
Hosetail

Code	Hose ID	Male	Colour
09-603-0402	4mm	1/8 BSPT	Blue
09-603-0404	4mm	1/4 BSPT	Blue
09-603-0502	5mm	1/8 BSPT	Blue
09-603-0504	5mm	1/4 BSPT	Blue
09-603-0602	6mm	1/8 BSPT	Blue
09-603-0604	6mm	1/4 BSPT	Blue
09-603-0606	6mm	3/8 BSPT	Blue
09-603-0608	6mm	1/2 BSPT	Blue
09-603-0802	8mm	1/8 BSPT	Blue
09-603-0804	8mm	1/4 BSPT	Blue
09-603-0806	8mm	3/8 BSPT	Blue
09-603-0808	8mm	1/2 BSPT	Blue
09-603-1004	10mm	1/4 BSPT	Blue
09-603-1006	10mm	3/8 BSPT	Blue
09-603-1008	10mm	1/2 BSPT	Blue
09-603-1012	10mm	3/4 BSPT	Blue
09-603-1204	12mm	1/4 BSPT	Blue
09-603-1206	12mm	3/8 BSPT	Blue
09-603-1208	12mm	1/2 BSPT	Blue
09-603-1212	12mm	3/4 BSPT	Blue
09-603-1406	14mm	3/8 BSPT	Blue
09-603-1608	16mm	1/2 BSPT	Blue
09-603-1612	16mm	3/4 BSPT	Blue
09-603-1908	19mm	1/2 BSPT	Blue
09-603-1912	19mm	3/4 BSPT	Blue
09-603-2516	25mm	1" BSPT	Black
09-603-3220	32mm	1.1/4 BSPT	Black
09-603-4024	40mm	1.1/2 BSPT	Black
09-603-5032	50mm	2" BSPT	Black



P7N
Hose
Joiner

Code	Hose ID	Colour
09-607-03	3mm	White
09-607-04	4mm	Blue
09-607-05	5mm	White
09-607-06	6mm	Blue
09-607-08	8mm	Blue
09-607-10	10mm	Blue
09-607-12	12mm	Blue
09-607-14	14mm	Blue
09-607-16	16mm	Blue
09-607-19	19mm	Blue
09-607-25	25mm	Black



P5N
Nut & Tail
Cone Seat

Code	Hose ID	Female	Colour
09-605-0402	4mm	1/8 BSP	Blue
09-605-0404	4mm	1/4 BSP	Blue
09-605-0502	5mm	1/8 BSP	Blue
09-605-0504	5mm	1/4 BSP	Blue
09-605-0506	5mm	3/8 BSP	Blue
09-605-0604	6mm	1/4 BSP	Blue
09-605-0606	6mm	3/8 BSP	Blue
09-605-0608	6mm	1/2 BSP	Blue
09-605-0804	8mm	1/4 BSP	Blue
09-605-0806	8mm	3/8 BSP	Blue
09-605-0808	8mm	1/2 BSP	Blue
09-605-0812	8mm	3/4 BSP	Blue
09-605-1006	10mm	3/8 BSP	Blue
09-605-1008	10mm	1/2 BSP	Blue
09-605-1012	10mm	3/4 BSP	Blue
09-605-1208	12mm	1/2 BSP	Blue
09-605-1212	12mm	3/4 BSP	Blue
09-605-1612	16mm	3/4 BSP	Blue
09-605-1912	19mm	3/4 BSP	Blue



P6N
Male Hose
Elbow

Code	Hose ID	Male	Colour
09-606-0402	4mm	1/8 BSPT	Blue
09-606-0404	4mm	1/4 BSPT	Blue
09-606-0502	5mm	1/8 BSPT	Blue
09-606-0504	5mm	1/4 BSPT	Blue
09-606-0602	6mm	1/8 BSPT	Blue
09-606-0604	6mm	1/4 BSPT	Blue
09-606-0606	6mm	3/8 BSPT	Blue
09-606-0608	6mm	1/2 BSPT	Blue
09-606-0802	8mm	1/8 BSPT	Blue
09-606-0804	8mm	1/4 BSPT	Blue
09-606-0806	8mm	3/8 BSPT	Blue
09-606-0808	8mm	1/2 BSPT	Blue
09-606-1004	10mm	1/4 BSPT	Blue
09-606-1006	10mm	3/8 BSPT	Blue
09-606-1008	10mm	1/2 BSPT	Blue
09-606-1012	10mm	3/4 BSPT	Blue
09-606-1204	12mm	1/4 BSPT	Blue
09-606-1206	12mm	3/8 BSPT	Blue
09-606-1208	12mm	1/2 BSPT	Blue
09-606-1212	12mm	3/4 BSPT	Blue
09-606-1406	14mm	3/8 BSPT	Blue
09-606-1408	14mm	1/2 BSPT	Blue
09-606-1608	16mm	1/2 BSPT	Blue
09-606-1612	16mm	3/4 BSPT	Blue
09-606-1908	19mm	1/2 BSPT	Blue
09-606-1912	19mm	3/4 BSPT	Blue
09-606-2516	25mm	1" BSPT	Grey

NYLON HOSE FITTINGS (Category 9)



P7RN
Reducing
Hose Joiner

Code	Hose	Hose	Colour
09-607R-0504	5mm	4mm	Blue
09-607R-0604	6mm	4mm	Blue
09-607R-0605	6mm	5mm	Blue
09-607R-0805	8mm	5mm	Blue
09-607R-0806	8mm	6mm	Blue
09-607R-1006	10mm	6mm	Blue
09-607R-1008	10mm	8mm	Blue
09-607R-1208	12mm	8mm	Blue
09-607R-1210	12mm	10mm	Blue
09-607R-1612	16mm	12mm	Blue
09-607R-1916	19mm	16mm	Blue



P10N
Female
Hosetail

Code	Hose	Female	Colour
09-610-0602	6mm	1/8 BSP	Blue
09-610-0604	6mm	1/4 BSP	Blue
09-610-0804	8mm	1/4 BSP	Blue
09-610-1004	10mm	1/4 BSP	Blue
09-610-1006	10mm	3/8 BSP	Blue
09-610-1008	10mm	1/2 BSP	Blue
09-610-1204	12mm	1/4 BSP	Blue
09-610-1206	12mm	3/8 BSP	Blue
09-610-1208	12mm	1/2 BSP	Blue
09-610-1608	16mm	1/2 BSP	Blue
09-610-1908	19mm	1/2 BSP	Blue



P11N
Hose
Elbow

Code	Hose	Colour
09-611-04	4mm	Blue
09-611-05	5mm	Blue
09-611-06	6mm	Blue
09-611-08	8mm	Blue
09-611-10	10mm	Blue
09-611-12	12mm	Blue
09-611-16	16mm	Blue
09-611-19	19mm	Blue
09-611-25	25mm	White

Note : Colours listed are correct at the time of publication, but are subject to change



P11RN
Reducing
Hose
Elbow

Code	Hose	Hose	Colour
09-611R-1008	10mm	8mm	Blue
09-611R-1210	12mm	10mm	Blue
09-611R-1916	19mm	16mm	Blue



P12N
Male Branch
Hose Tee

Code	Hose	Male	Colour
09-612-0402	4mm	1/8 BSPT	Blue
09-612-0404	4mm	1/4 BSPT	Blue
09-612-0502	5mm	1/8 BSPT	Blue
09-612-0504	5mm	1/4 BSPT	Blue
09-612-0602	6mm	1/8 BSPT	Blue
09-612-0604	6mm	1/4 BSPT	Blue
09-612-0606	6mm	3/8 BSPT	Blue
09-612-0608	6mm	1/2 BSPT	Blue
09-612-0802	8mm	1/8 BSPT	Blue
09-612-0804	8mm	1/4 BSPT	Blue
09-612-0806	8mm	3/8 BSPT	Blue
09-612-0808	8mm	1/2 BSPT	Blue
09-612-1004	10mm	1/4 BSPT	Blue
09-612-1006	10mm	3/8 BSPT	Blue
09-612-1008	10mm	1/2 BSPT	Blue
09-612-1012	10mm	3/4 BSPT	Blue
09-612-1204	12mm	1/4 BSPT	Blue
09-612-1206	12mm	3/8 BSPT	Blue
09-612-1208	12mm	1/2 BSPT	Blue
09-612-1212	12mm	3/4 BSPT	Blue
09-612-1608	16mm	1/2 BSPT	Blue
09-612-1612	16mm	3/4 BSPT	Blue
09-612-1908	19mm	1/2 BSPT	Blue
09-612-1912	19mm	3/4 BSPT	Blue



P14N
Hose
Tee

Code	Hose	Colour
09-614-03	3mm	White
09-614-04	4mm	White
09-614-05	5mm	White
09-614-06	6mm	Blue
09-614-08	8mm	Blue
09-614-10	10mm	Blue
09-614-12	12mm	Blue
09-614-16	16mm	Blue
09-614-19	19mm	Blue
09-614-25	25mm	White



P14RN
Reducing
Hose Tee

Code	Hose	Hose	Colour
09-614R-0504	5mm	4mm	Blue
09-614R-0605	6mm	5mm	Blue
09-614R-0806	8mm	6mm	Blue
09-614R-1008	10mm	8mm	Blue
09-614R-1210	12mm	10mm	Blue
09-614R-1916	19mm	16mm	Blue



P25N
Nut & Tail
Flat Seat

Code	Hose	Female	Colour
09-625-1012	10mm	3/4 BSP	Black
09-625-1212	12mm	3/4 BSP	Black
09-625-1216	12mm	1" BSP	Black
09-625-1612	16mm	3/4 BSP	Black
09-625-1912	19mm	3/4 BSP	Black
09-625-1916	19mm	1" BSP	Black
09-625-2516	25mm	1" BSP	Black
09-625-3220	32mm	1.1/4 BSP	Black
09-625-4024	40mm	1.1/2 BSP	Black
09-625-5032	50mm	2" BSP	Black



P68N
Hose
Cross

Code	Hose	Colour
09-668-04	4mm	White
09-668-05	5mm	White
09-668-06	6mm	White
09-668-12	12mm	White



P75
Hose
"Y"

Code	Hose	Colour
09-675-03	3mm	White
09-675-04	4mm	Blue
09-675-05	5mm	White
09-675-06	6mm	Blue
09-675-08	8mm	Blue
09-675-10	10mm	White
09-675-12	12mm	White
09-675-16	16mm	White

AUTOMOTIVE SPECIAL FITTINGS (Category 10)



Master Cylinder Adaptors

Code	Female		Male Inverted Flare Thread
	Tube	Thread	
10-7910	3/16	3/8x24 UNF	9/16x20
10-7911	3/16	3/8x24 UNF	9/16x18

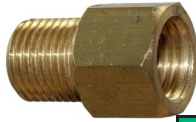

Metric Brake Adaptors

Code	Tube	Female		Male Thread
		Thread		
10-M120-5	1/4	M12x1		M10x1
10-M120-7	3/16	3/8x24 UNF		M10x1

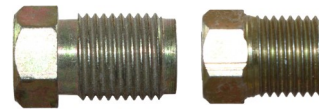

Non Standard Tube Nuts

Code	Tube	Thread	Length	Relieved
10-P4276	3/16	3/8x20	23mm	Yes
10-P4285	3/16	3/8x24	20mm	Yes
10-P5842	3/16	7/16x24	15mm	No
10-P4511	3/16	M10x1	15mm	No
10-P4743	3/16	M10x1	18mm	No
10-P4511L	3/16	M10x1	20mm	Yes
10-P4511LT	3/16	M10x1	20mm	No
10-P5532	1/4	7/16x24	20mm	Yes
10-P105-6-7	3/8	11/16x18	16mm	No
10-P4512	5mm	M10x1.25	15mm	No



Metric Bracketed Tube Tee

Code	Tube	Thread
10-M702-10	3/16	M10x1



Dole Pattern Tube Nuts

Code	Tube	Thread
10-DP02	1/8	5/16x24
10-DP03	3/16	3/8x24
10-DP04	1/4	7/16x24



Male Inverted Flare Tails

Code	Hose	Male
10-P.306M16	10mm	M16x1.5



Female Inverted Flare Tails

Code	Hose	Male
10-P1006M16	10mm	M16x1.5
10-P1006U10	10mm	5/8 UNF



CAV Fuel Filter Fittings

Code	Hose	Male
10-CAV04	1/4	1/2x20 CAV
10-CAV05	5/16	1/2x20 CAV
10-CAV06	3/8	1/2x20 CAV



1/4 BSPT x 1/2x20 CAV Straight Adaptor

Code : 10-CAV02



1/4 BSPT x 1/2x20 CAV Elbow Adaptor

Code : 10-CAV03



XF Falcon temp sender adaptor. 5/8 Hose x 3/8 NPT

Code : 10-FT10



XF Falcon heater hose rear Tee piece 5/8 Hose x 3/8 NPT

Code : 10-FT11



Holley Carburetor Hose Fittings

Code	Hose	Male
10-HOL002	3/8	7/8x20 Holley
10-HOL001	1/2	7/8x20 Holley



Impco LPG Mixer Screw

Code : 10-F4-2



Impco LPG 10mm Nipple

Code : 10-LPG2710



Impco LPG 10mm x 5/16 Flare Nipple

Code : 10-LPG70510



Impco LPG 10mm x 5/16 Flare Elbow

Code : 10-LPG80510



Impco LPG 10mm Adaptors

Code	Male	Male
10-LPG731002N	M10	1/8 NPT
10-LPG731004	M10	1/4 BSPT
10-LPG731004N	M10	1/4 NPT



Temperature Sender Adaptors

Refer to #54 fittings in flare section of Category 1

Standard SAE Inverted Flare fittings can be found in Category 1 if they are tube to tube or tube to BSP Fittings. Tube to NPT fittings can be found in Category 2.

Black Nylon Cable Ties (Category 11)

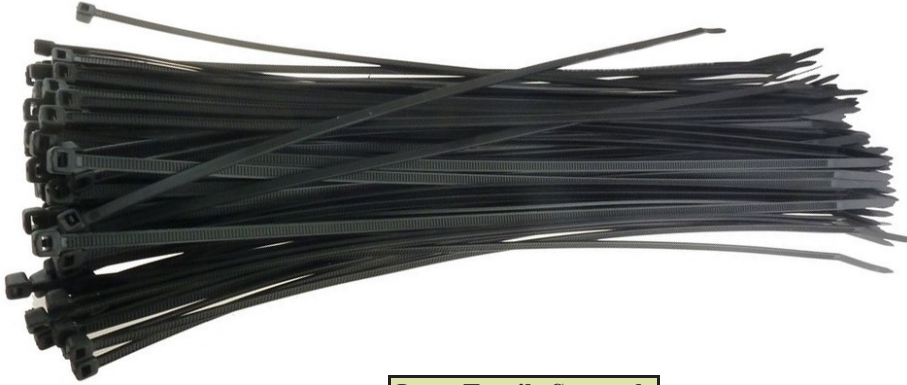

Code	Length	Width	Qty	Loop Tensile Strength	
				Newton	lbf
11-CT010025	100mm	2.5mm	100	80	18
11-CT015035	150mm	3.5mm	100	178	40
11-CT020025	200mm	2.5mm	100	80	18
11-CT020035	200mm	3.5mm	100	178	40
11-CT020047	200mm	4.7mm	100	222	50
11-CT025035	250mm	3.5mm	100	178	40
11-CT025047	250mm	4.7mm	100	222	50
11-CT030035	300mm	3.5mm	100	178	40
11-CT030047	300mm	4.7mm	100	222	50
11-CT030075	300mm	7.5mm	100	534	120
11-CT037075	370mm	7.5mm	100	534	120
11-CT038047	380mm	4.7mm	100	222	50
11-CT043047	430mm	4.7mm	100	222	50
11-CT053013	530mm	13mm	25	1112	250
11-CT055075	550mm	7.5mm	50	534	120
11-CT055090	550mm	9mm	50	778	175
11-CT076090	760mm	9mm	25	778	175
11-CT102090	1020mm	9mm	25	778	175

- Manufactured from Black Nylon 66
- UV Stabilised and Weather Resistant.
- Heat Resistant. Certified 94V-2 by Underwriters Laboratories Inc
- Operating Temperature -
- -35°C to 85°C



Certification File E359184

Cable Tie Stands Also Available

Nylon Cable Tie Assortments (Category 11)



Code : 11-CT1000K

Size	Colour	Qty
100x2.5	Black	200
150x3.5	Black	200
200x4.7	Black	200
300x4.7	Black	200
370x7.5	Black	200

Code : 11-CT1000TP

Size	Colour	Qty
100x2.5	Black	200
150x3.5	Black	200
200x4.7	Black	200
250x4.7	Black	200
300x4.7	Black	200



Code : 11-CTP850

Size	Colour	Qty
100x2.5	Blue	100
100x2.5	Red	100
100x2.5	Yellow	100
100x2.5	Green	100
100x2.5	Natural	100
200x4.8	Natural	300
280x4.8	Natural	50

Code : 11-CTP400

Size	Colour	Qty
100x2.5	Blue	50
100x2.5	Red	50
100x2.5	Yellow	50
100x2.5	Green	50
100x2.5	Natural	100
150x3.3	Natural	100

Code : 11-CTP1200

Size	Colour	Qty
100x2.5	Black	200
100x2.5	Natural	200
100x2.5	Red	100
100x2.5	Green	100
100x2.5	Blue	100
100x2.5	Yellow	100
200x4.8	Natural	350
280x4.8	Natural	50

Stainless Steel Cable Ties (Category 11)



Code	Length	Width	Qty	Tensile Strength	
				Newton	lbf
11-CTSS020046	200mm	4.6mm	50	445	100
11-CTSS030046	300mm	4.6mm	50	445	100
11-CTSS030079	300mm	7.9mm	25	783	176
11-CTSS040046	400mm	4.6mm	50	445	100
11-CTSS040079	400mm	7.9mm	25	783	176
11-CTSS052046	520mm	4.6mm	50	445	100
11-CTSS052079	520mm	7.9mm	25	783	176
11-CTSS084079	840mm	7.9mm	10	783	176
11-CTSS105079	1050mm	7.9mm	10	783	176

Cable Tie Tools (Category 11)



Code : 11-CTG519

Heavy Duty Metal Tensioning and Cutting for Ties up to 9mm wide. Has automatic Cut Off



Code : 11-CTG100

Light Duty Tensioning and Cutting for Ties up to 4.8mm wide. Recommended for DIY use



Code : 11-CTG600A

Heavy Duty Metal Tensioning and Cutting for Ties up to 4.8mm wide. Has automatic Cut Off



Code : 11-CTG001

Tensioning and Cutting for Stainless Steel Cable Ties up to 7.9 mm wide.

Zinc Plated Steel Saddles & Clips (Category 11)



Double Sided Zinc Plated Steel Saddle

Code	Size
11-ZPS04	1/4
11-ZPS05	5/16
11-ZPS06	3/8
11-ZPS08	1/2
11-ZPS10	5/8
11-ZPS12	3/4
11-ZPS16	1"
11-ZPS20	1.1/4
11-ZPS24	1.1/2
11-ZPS32	2"



Single Sided Zinc Plated Steel Clip

Code	Size
11-ZPC03	3/16
11-ZPC04	1/4
11-ZPC05	5/16
11-ZPC06	3/8
11-ZPC08	1/2
11-ZPC10	5/8
11-ZPC12	3/4
11-ZPC16	1"

Some saddles and clips available in powder coated or Chrome finish. Contact the sales office to discuss your requirements.

Copper Saddles & Clips (Category 11)



Double Sided Copper Saddle

Code	Size
11-CS04	1/4
11-CS05	5/16
11-CS06	3/8
11-CS08	1/2
11-CS10	5/8
11-CS12	3/4
11-CS14	7/8
11-CS16	1"

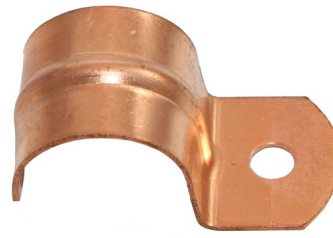

Single Sided Copper Clip

Code	Size
11-CC03	3/16
11-CC04	1/4
11-CC05	5/16
11-CC06	3/8
11-CC10	5/8
11-CC12	3/4

Stainless Steel Saddles (Category 11)



Code	Description
11-SS04	1/4 - 1 Way
11-SS04-2	1/4 - 2 Way
11-SS04-3	1/4 - 3 Way
11-SS04-4	1/4 - 4 Way
11-SS05	5/16 - 1 Way
11-SS05-2	5/16 - 2 Way
11-SS05-3	5/16 - 3 Way
11-SS05-4	5/16 - 4 Way
11-SS05-5	5/16 - 5 Way
11-SS05-6	5/16 - 6 Way

Code	Description
11-SS06	3/8 - 1 Way
11-SS06-2	3/8 - 2 Way
11-SS06-3	3/8 - 3 Way
11-SS06-4	3/8 - 4 Way
11-SS08	1/2 - 1 Way
11-SS08-2	1/2 - 2 Way
11-SS08-3	1/2 - 3 Way
11-SS08-4	1/2 - 4 Way
11-SS12	3/4 - 1 Way
11-SS16	1" - 1 Way
11-SS24	1.1/2 - Way

Rubber Lined P Clips (Category 11)



W1



These rubber lined connecting clamps, known in the market as P-Clips are composed of a zinc plated mild steel band lined with EPDM rubber. This rubber lining allows for firm and safe clamping in the application zone and prevents potential damage due to vibration. The screw holes at either end of the band are reinforced with steel plates to ensure they clamp down firmly. The zinc plating increases the resistance to corrosion. P-Clips are particularly recommended for mounting pipes, electric cable ducting and hoses in a multitude of different applications.

W1 Materials

Band:
Mild steel reinforced at both ends

Finish:
Galvanized and lined with EPDM rubber

Code	Size	a	d
11-P03	3 mm	12	6.0
11-P05	5 mm	12	5.3
11-P06	6 mm	12	5.3
11-P08	8 mm	12	5.3
11-P10	10 mm	12	5.3
11-P12	12 mm	12	5.3
11-P13	13 mm	12	5.3
11-P14	14 mm	12	5.3
11-P16	16 mm	12	5.3
11-P18	18 mm	12	5.3
11-P19	19 mm	12	5.3
11-P20	20 mm	12	5.3
11-P22	22 mm	12	5.3
11-P24	24 mm	12	5.3
11-P25	25 mm	12	5.3
11-P27	27 mm	12	5.3
11-P28	28 mm	15	6.4
11-P30	30 mm	15	6.4
11-P32	32 mm	15	6.4
11-P34	34 mm	15	6.4
11-P35	35 mm	15	6.4
11-P37	37 mm	15	6.4
11-P38	38 mm	15	6.4
11-P45	45 mm	15	6.0
11-P50	50 mm	20	6.0
11-P60	60 mm	20	6.0
11-P76	76 mm	20	6.0

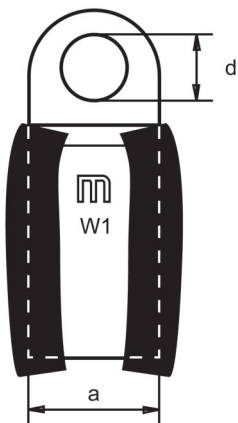

SWIVEL FITTINGS (Category 12)

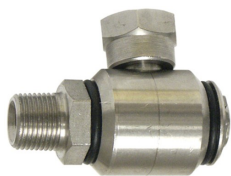

High Pressure 90 Degree Boom Swivels. 360 Degree Rotation

		Brass		Stainless Steel	
Male	Female	Code	W/Pres	Code	W/Pres
3/8 NPT	3/8 NPSM	12-BH25N-0606	3000 psi	12-SSH25N-0606	5000 psi



High Pressure M&F Swivels

		Brass		Stainless Steel	
Male	Female	Code	W/Pres	Code	W/Pres
1/4 NPT	1/4 NPT	12-BH72N-0404	3000 psi	12-SSH72N-0404	5000 psi
3/8 NPT	3/8 NPT	12-BH72N-0606	3000 psi	12-SSH72N-0606	5000 psi



3/8 NPT Brass Female
3000 psi Swivel

Code : 12-BH26N-0606



1/4 BSPT Male
Ball Swivel

Code : 12-BSM04



1/2 NPT Brass Female 90 Degree
3000 psi Swivel

Code : 12-BH34N-0808

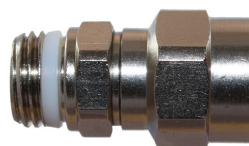

Low Pressure Nickel Plated
Brass M&F Swivels

Repair Kits for High Pressure Swivels



Male	Female	Code	W/Pres
1/8 BSPT	1/8 BSP	12-BL72-0202	500psi
1/4 BSPT	1/4 BSP	12-BL72-0404	500psi
3/8 BSPT	3/8 BSP	12-BL72-0606	500psi

Code	Suits
12-RK04	1/4 Swivels SSH72N. BH72N
12-RK06	3/8 Swivels SSH72N. BH72N. BH26N
12-RK06-90	3/8 90 Degree Swivels BH25N. SSH25N
12-RK08-90	1/2 90 Degree Swivels BH34N

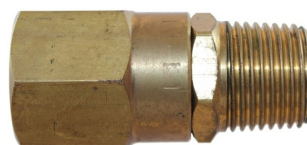

IFS Low Pressure Brass
M&F Swivels

Male	Female	Code	W/Pres
1/2 BSPT	1/2 BSP	12-BL72-0808	300 psi
3/4 BSPT	3/4 BSP	12-BL72-1212	300 psi
1" BSPT	1" BSP	12-BL72-1616	300 psi

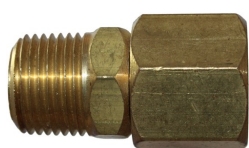

Medium Pressure Brass
M&F Swivels

Male	Female	Code	W/Pres
3/8 NPT	1/4 NPT	12-BL72N-0604	1200 psi
3/8 NPT	3/8 NPT	12-BL72N-0606	1200 psi
1/2 NPT	1/2 NPT	12-BL72N-0808	1000 psi

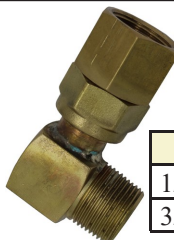

Medium Pressure Brass 90
Degree M&F Swivels

Male	Female	Code	W/Pres
1/2 BSPT	1/2 BSP	12-BL25-0808	2200 psi
3/4 BSPT	3/4 BSP	12-BL25-1212	800 psi

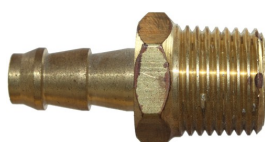

3/8 Pushlok x 1/2 NPT Male
Brass Swivel

Code : 12-BP3N-0608



1/4 BSP M&F
Ball Swivel

Code : 12-BSF04

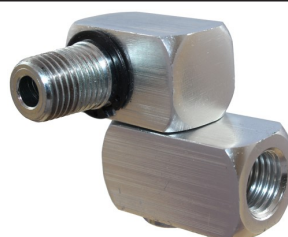

1/4 BSP M&F Swivel.
Full 360° Rotation.
Allows Air Hose to Drop
Directly to the Floor

Code : 12-S322

PVC Hose (Category 13)

Super Uniflex Air Hose



Blue with Yellow Stripe



Australian Made

Code	I.D	O.D	Working Pressure	Burst Pressure	Coil Length	Reel Length
13-SUF04	6.3mm (1/4)	12.9mm	232 psi / 1600 kpa	928 psi / 6400 kpa	20m/100m	300m
13-SUF05	8mm (5/16)	14.6mm	232 psi / 1600 kpa	928 psi / 6400 kpa	20m/100m	300m
13-SUF06	10mm (3/8)	16.6mm	232 psi / 1600 kpa	928 psi / 6400 kpa	20m/30m/50m/100m	300m
13-SUF08	12.5mm (1/2)	19.1mm	232 psi / 1600 kpa	928 psi / 6400 kpa	20m/30m/50m/100m	200m
13-SUF12	20mm (3/4)	27.6mm	204 psi / 1400 kpa	812 psi / 5600 kpa	20m/30m/100m	
13-SUF16	25mm (1")	33.5mm	204 psi / 1400 kpa	812 psi / 5600 kpa	20m/30m/100m	

- Ease of handling in extreme cold conditions
- Manufactured from oil resistant compounds
- High abrasion resistance for long life
- Good weathering properties
- Blue cover denoting air line
- Identifiable by bright Yellow stripe

Esdan Super Uniflex hose is specifically designed for air tool applications such as staple machines, air screw drivers, car tyre pump hose, nail guns and pneumatic tools. The hose is tough and abrasion resistant, yet extremely flexible so as to ensure maximum reduction in operator wrist strain. All the stringent requirements of AS 2554 Class B are met by the Super Uniflex.



Most hoses available with various fitted ends including couplers, male and female threads, blowguns and tyre chucks.

Contact the sales office with your requirements

Clear Multi Purpose Hose

Food Grade and Fuel Resistant



Code	I.D.	O.D	Working Pressure @23°C	Burst Pressure @23°C	Coil Length	Reel Length
13-CMP04	6.3mm (1/4)	10.4 mm	232 psi / 1600 kpa	928 psi / 6400 kpa	20m/50m/100m	300m
13-CMP05	8mm (5/16)	12.4 mm	232 psi / 1600 kpa	928 psi / 6400 kpa	20m/100m	300m
13-CMP06	10mm (3/8)	15.2 mm	232 psi / 1600 kpa	928 psi / 6400 kpa	20m/100m	200m/300m
13-CMP08	12.5mm (1/2)	18.1 mm	232 psi / 1600 kpa	928 psi / 6400 kpa	20m/100m	200m/300m
13-CMP10	16mm (5/8)	22.4 mm	232 psi / 1600 kpa	928 psi / 6400 kpa	20m/100m	
13-CMP12	20mm (3/4)	27.6 mm	232 psi / 1600 kpa	928 psi / 6400 kpa	10m/20m/100m	
13-CMP16	25mm (1")	33.5 mm	203 psi / 1400 kpa	812 psi / 5600 kpa	10m/20m/100m	
13-CMP20	32mm (1.1/4)	41.8 mm	145 psi / 1000 kpa	580 psi / 4000 kpa	5m/10m/20m/60m	
13-CMP24	38mm (1.1/2)	49.7 mm	130 psi / 900 kpa	522 psi / 3600 kpa	5m/10m/20m/40m	
13-CMP32	50mm (2")	62 mm	130 psi / 900 kpa	522 psi / 3600 kpa	5m/10m/20m/40m	

- High resistance to crushing & abrasion
- Excellent clarity
- Conforms to AS2070 standard
- Temperature range: 0°C to +50°C



Australian Made

CMP hose is a reinforced pressure hose designed for food contact applications such as potable water, beverages and other food lines where inspection of hose and product is required. It has a smooth bore which reduces pressure drop and provides excellent flow characteristics. Suitable for a broad range of industrial uses including conveying petrol, kerosene & oil, the hose has a red spiralled tracer yarn to indicate it's suitability for petrol transfer. CMP is ideally suited for marine, recreational, agricultural & other industries.

PVC Hose (Category 13)

ExtraFlex Air and Water Hose

- All Australian made
- Tough ribbed cover for abrasion resistance
- Bright Yellow cover with blue stripe for safety
- Oil resistant inner tube.
- Ozone resistant outer for long service life
- Conforms to AS2554 Class E standard
- Temperature range: -0°C to +60°C
- Minimum safety factor of 4:1 allowing for pressure surges & variation in temperature
- Fully reinforced with high tensile polyester



Esdan Extraflex is an air-water hose is designed to comply with AS 2554 Class E, and is probably the most versatile hose available today with its unique low temperature characteristics and outstanding flexibility in any climatic condition.

The abrasion resistant hose is reinforced with high tensile polyester cord and is the first choice in any market sector.

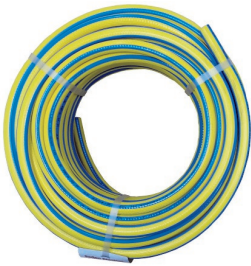

Code	I.D.	O.D.	Working Pressure @23°C	Burst Pressure @23°C	Coil Length	Reel Length
13-EF06	10mm (3/8)	17.2mm	290 psi / 2000 kpa	928 psi / 6400 kpa	20m/100m	300m
13-EF08	12.5mm (1/2)	18.9mm	290 psi / 2000 kpa	928 psi / 6400 kpa	20m/100m	200m/300m
13-EF12	19mm (3/4)	27.6mm	232 psi / 1600 kpa	928 psi / 6400 kpa	20m/100m	
13-EF16	25mm (1")	34.2mm	232 psi / 1600 kpa	928 psi / 6400 kpa	20m/100m	

Safety Yellow Hose

- All Australian made
- Tough ribbed cover for abrasion resistance
- Bright Yellow cover for industrial safety
- Oil resistant inner tube.
- Ozone resistant outer for long service life
- Temperature range: -0°C to +50°C
- Minimum safety factor of 4:1 allowing for pressure surges & variation in temperature
- Fully reinforced with high tensile polyester



Code	I.D.	O.D.	Working Pressure @23°C	Burst Pressure @23°C	Coil Length
13-SY16	25mm (1")	34.2 mm	232 psi / 1600 kpa	928 psi / 6400 kpa	20m/100m
13-SY20	32mm (1.1/4)	41.8 mm	232 psi / 1600 kpa	928 psi / 6400 kpa	20m/60m
13-SY24	40mm (1.1/2)	52.4 mm	232 psi / 1600 kpa	928 psi / 6400 kpa	20m/40m
13-SY32	50mm (2")	62 mm	232 psi / 1600 kpa	928 psi / 6400 kpa	20m/40m

Please note : Safety Yellow Hose replaced by Super Uniflex in 1/4 and 5/16. For 3/8, 1/2 or 3/4, please refer to Super Uniflex or Extraflex Hose.

Esdan SY is a general purpose hose suitable for industrial air and water applications. Its yellow ribbed cover and heavy duty construction gives this hose excellent abrasion and kink resistance maintaining good flexibility and weathering properties. SY has been designed to perform in the tough Australian industrial environment and accordingly it exceeds all the requirements of AS2554 Class B

Divers Air Breathing Hose

Hookah Diving Hose

- Bright Yellow Outer
- Excellent kink resistance
- Low temperature flexibility
- For use in the applications of Australian standards AS 2299 & AS/NZS 1716
- Fits all hookah diving apparatus



Code	I.D.	O.D.	Working Pressure @23°C	Burst Pressure @23°C	Coil Length	Reel Length
13-DB05	8mm (5/16)	14.4 mm	348 psi / 2400 kpa	1392 psi / 9600 kpa	20m/100m	300m
13-DB06	10mm (3/8)	17.6 mm	348 psi / 2400 kpa	1392 psi / 9600 kpa	20m/50m/100m	300m

A bright yellow hose with an inner of food grade P.V.C. The divers air breathing hose has excellent kink resistance Primarily used in the diving industry but is now used extensively for all breathing apparatus. For use in the applications of AS 2299 and AS/NZS 1716. This hose is ideal for the use in all Hookah diving systems and applications.

PVC Hose (Category 13)

Clear Vinyl Tube (CVT)

Non Toxic Food Grade Tube



Esdan high grade clear CVT tubes are suitable for transferring air, water and some petrochemicals at low pressure. Esdan CVT tube is also highly flexible, light in weight, corrosion & abrasion resistant, whilst its clearness allows any blockages to be easily detected.

- All Australian made
- Does not taint liquid
- Crystal clear for ease of inspection
- Conforms to AS2070 standard
- Temperature range: -0°C to +50°C
- Abrasion resistant

Code	I.D.	O.D	Working Pressure @23°C	Burst Pressure @23°C	Coil/Spool Length
13-CVT02	3mm (1/8)	5 mm	116 psi / 800 kpa	464 psi / 3200 kpa	30m/50m/100m
13-CVT025	4mm (5/32)	6 mm	101 psi / 700 kpa	404 psi / 2780 kpa	30m/50m/100m
13-CVT03	5mm (3/16)	8 mm	101 psi / 700 kpa	404 psi / 2780 kpa	30m/50m/100m
13-CVT04	6mm (1/4)	9 mm	87 psi / 600 kpa	348 psi / 2400 kpa	30m/50m/100m
13-CVT05	8mm (5/16)	11 mm	72 psi / 500 kpa	288 psi / 1980 kpa	30m/50m/100m
13-CVT06	10mm (3/8)	13 mm	58 psi / 400 kpa	232 psi / 1600 kpa	30m/50m/100m
13-CVT06H	10mm (3/8)	15 mm	72 psi / 500 kpa	288 psi / 1980 kpa	30m
13-CVT08	12.5mm (1/2)	15.5 mm	58 psi / 400 kpa	232 psi / 1600 kpa	30m/50m/100m
13-CVT10	16mm (5/8)	19 mm	58 psi / 400 kpa	232 psi / 1600 kpa	30m
13-CVT12	19mm (3/4)	23 mm	43 psi / 300 kpa	172 psi / 1190 kpa	30m
13-CVT16	25mm (1")	31 mm	43 psi / 300 kpa	172 psi / 1190 kpa	30m
13-CVT20	32mm (1.1/4)	38 mm	25 psi / 170 kpa	100 psi / 690 kpa	15m/30m
13-CVT24	40mm (1.1/2)	47 mm	25 psi / 170 kpa	100 psi / 690 kpa	15m/30m
13-CVT32	50mm (2")	58 mm	29 psi / 200 kpa	116 psi / 800 kpa	15m/30m

PR Clear Vinyl Tube

Petrol Resistant



- All Australian made
- Petrol resistant
- Corrosion & abrasion resistant
- Light weight
- Translucent Pink for easy identification
- Capable of carrying dilute acids
- Temperature range: -0°C to +50°C
- Oil resistant
- Capable of carrying most alkalies

Code	I.D.	O.D	Working Pressure @23°C	Burst Pressure @23°C	Spool Length
13-CVTR02	3mm (1/8)	5 mm	116 psi / 800 kpa	464 psi / 3200 kpa	50m
13-CVTR03	5mm (3/16)	8 mm	101 psi / 700 kpa	404 psi / 2780 kpa	50m
13-CVTR04	6mm (1/4)	9 mm	87 psi / 600 kpa	348 psi / 2400 kpa	50m
13-CVTR05	8mm (5/16)	11 mm	72 psi / 500 kpa	288 psi / 1980 kpa	50m
13-CVTR06	10mm (3/8)	13 mm	58 psi / 400 kpa	232 psi / 1600 kpa	50m
13-CVTR08	12.5mm (1/2)	15.5 mm	58 psi / 400 kpa	232 psi / 1600 kpa	50m

Esdan high grade clear pink tint PRCVT tubes are suitable for conveying most liquids including dilute acids and alkalies as well as low pressure gases. It is also resistant to oil and most petrochemicals. Esdan Pink PRCVT tube is also highly flexible, light in weight, corrosion and abrasion resistant, whilst its clearness allows any blockages to be easily detected.

Black Vinyl Tube



Esdan high grade black Industrial Vinyl tubes are manufactured from food grade PVC ingredients. The tubes have a high gloss appearance and are highly flexible, light in weight, corrosion & abrasion resistant. It is oil resistant and capable of carrying most dilute acids and alkalies. All Esdan black Industrial PVC tubes are self extinguishing.

- Temperature range: -0°C to +50°C

Code	I.D.	O.D	Working Pressure @23°C	Burst Pressure @23°C	Coil Length
13-BVT02	3mm (1/8)	5 mm	116 psi / 800 kpa	464 psi / 3200 kpa	30m
13-BVT03	5mm (3/16)	8 mm	101 psi / 700 kpa	404 psi / 2780 kpa	30m
13-BVT04	6mm (1/4)	9 mm	87 psi / 600 kpa	348 psi / 2400 kpa	30m
13-BVT05	8mm (5/16)	11 mm	72 psi / 500 kpa	288 psi / 1980 kpa	30m
13-BVT06	10mm (3/8)	13 mm	58 psi / 400 kpa	232 psi / 1600 kpa	30m
13-BVT08	12.5mm (1/2)	15.5 mm	58 psi / 400 kpa	232 psi / 1600 kpa	30m

PVC Hose (Category 13)

Eliminator Pesticide Hose

Pesticide / Weedicide



- Specially formulated yellow inner for use with agricultural chemicals
- High kink resistance.
- Great flexibility for ease of handling.
- Operating temperature 0°C - +50°C

Code	I.D.	O.D	Working Pressure @23°C	Burst Pressure @23°C	Coil Length	Reel Length
13-EL05	8mm (5/16)	12.6mm	246 psi / 1700 kpa	985 psi / 6800 kpa	20m/100m	
13-EL06	10mm (3/8)	16.4 mm	246 psi / 1700 kpa	985 psi / 6800 kpa	20m/100m	
13-EL08	12.5mm (1/2)	18.9 mm	246 psi / 1700 kpa	985 psi / 6800 kpa	20m/100m	200m
13-EL12	20mm (3/4)	27.6 mm	246 psi / 1700 kpa	985 psi / 6800 kpa	20m/100m	
13-EL16	25mm (1")	34.2 mm	232 psi / 1600 kpa	928 psi / 6400 kpa	20m/100m	

Esdan Eliminator hose is a heavy duty PVC hose designed specifically for the demanding pest control industry. Suitable for the transfer of weedicides and pesticides in general horticultural, agricultural, pest and weed control applications. This hose is manufactured from compounds formulated specifically for their purpose and show good resistance to most solvent-based chemicals. Inherited in the design of this hose is a very high kink resistance essential in the pest control industry, yet maintains a high degree of flexibility for ease of handling.

Eliminator Pro High Pressure Pesticide Hose

Esdan Eliminator Pro is primarily designed for applications involving the high pressure transference of pesticides, weedicides and other chemicals generally involved in horticulture. The black outer layer gives this hose excellent UV stability, and the yellow stripe gives this hose an extra mark for identification purposes. Due to its high tensile reinforcing yarn, this hose has a working pressure of 600PSI and can be used for things like high pressure spraying and weedicide/pesticide sprayers.



- Australian made
- Abrasion resistant
- High tensile reinforcing yarn
- Made of UV resistant materials.
- Inner tubing is resistant to most chemicals
- Working pressure of 600PSI @ 23°C

Code	I.D.	O.D	Working Pressure @23°C	Coil Length
13-HPEL06	10mm (3/8)	17.4 mm	600 psi / 4130 kpa	20m/50m/100m/200m
13-HPEL08	12.5mm (1/2)	20.4 mm	600 psi / 4130 kpa	20m/50m/100m/200m

Black Fire Reel Hose

- Ribbed outer for high abrasion resistance
- UV stabilised for long life
- Excellent flexibility
- Meets Australian standards AS 1221
- Reinforced with high tenacity polyester yarn



Code	I.D.	O.D	Coil Length
13-FR12	19.25mm (3/4)	26.25 mm	20m/36m/100m
13-FR16	25mm (1")	34.2 mm	20m/36m/100m

A black PVC pressure hose suitable for use on fire reels. Excellent U.V resistance and stability for long life. With outstanding flexibility, this hose has a ribbed outer for high abrasion resistance. Meets Australian Standard AS 1221

Red & Yellow fire hose can be made to order

Working Pressure 145 psi (1000 kpa). Burst Pressure 580 psi (4000 kpa)



Fitted Assemblies also available

PVC Hose (Category 13)

Lawnmaster Garden Hose

- U.V Protected
- Fully Re-inforced
- Kink Resistant
- Thick Inner wall
- 3 year guarantee
- Australian Made

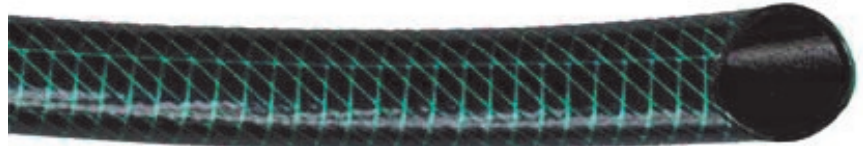

Fitted Garden Hoses also available. They are fitted with 2 x hose connectors, a tap adaptor and a spray nozzle.

Code	I.D.	Coil Length
13-G08	12mm (1/2)	18m/30m/50m/100m/200m
13-G12	18mm (3/4)	18m/30m/50m/100m
13-G16	25mm (1")	20m/100m

This general purpose budget green garden hose is great for domestic yards & many other general purpose applications.

Lawnflex Medium Duty Garden Hose

Esdan Safety LAWN FLEX is a premium quality strong and reliable hose for general agricultural and Industrial applications.

Especially designed for Australian conditions, It is perfect for domestic yards & commercial use. This hose has excellent kink resistance.

Esdan safety LAWN FLEX is designed as a highly visible safety hose to be identified with exceptional visibility in any environment. It is manufactured from quality virgin translucent PVC with excellent flexibility.

Esdan Safety Lawn Flex meets Australian Standard AS 2620-1

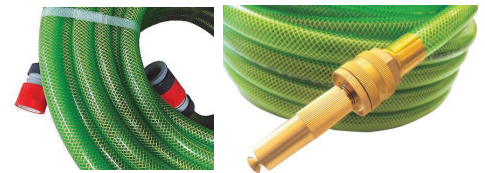

- Australian made Hose
- U.V Protected
- Fully Re-inforced, Thick Inner wall
- Outstanding Flexibility
- Distinctive Green/Yellow colour for exceptional visibility
- Excellent kink resistance

Brass fitted hose supplied with 2 x brass hose connectors and brass nozzle

Plastic fitted hose supplied with 2 x hose connectors and 1 x tap nut

Code	I.D.	Fitted Coil Length	Unfitted Coil Length
13-LFG08	12mm (1/2)	20m/30m	50m/100m
13-LFG12	18mm (3/4)	20m/35m	100m
13-LFG16	25mm (1")		20m/100m

Star Premium Duty Garden Hose

The Esdan Star Premium is the All-Australian quality green garden hose that has been especially designed to cope with the tough Australian conditions, including the harsh outback.

Star Premium is perfect for domestic yards & also commercial use. The hose has excellent kink resistance, a thick inner wall and is UV protected.

Esdan Star Premium Meets the Australian Standards AS 2620-1



- All Australian made
- U.V Protected
- Fully Re-inforced
- Meets Australian Standard AS 2620-1
- Excellent Kink Resistance
- Thick Inner wall
- 8 year guarantee
- Suits all click-on fittings, plastic or brass

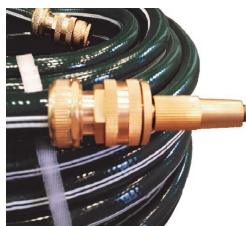
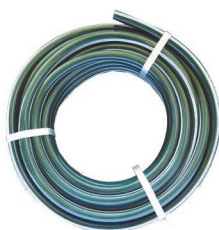

Fitted Coils Also Available

Code	I.D.	Coil Length
13-PG08	12mm (1/2)	20m/30m/50m/100m
13-PG12	18mm (3/4)	20m/30m/50m/100m

PVC Hose (Category 13)

Summer Blue Hose



The Esdan Summer Blue premium water hose is the All Australian quality hose that has been especially designed to cope with the tough Australian conditions, including the harsh outback.

Summer Blue is perfect for domestic yards & also commercial use. The hose has excellent kink resistance, a thick inner wall and is UV protected.

Esdan Summer Blue meets the Australian Standard AS 2620-1

- Fully Re-inforced
- Outstanding flexibility
- Suits all click-on fittings, plastic or brass
- Distinctive Blue colour offers exceptional visibility
- 6 year guarantee

Code	I.D.	Coil Length
13-SB12	18mm (3/4)	20m/30m/50m/100m
13-SB16	25mm (1")	20m/30m/50m/100m

Estate Washdown Hose

- All Australian made
- Tough, high abrasion resistant cover
- Bright white cover for high visibility
- Good flexibility for ease of handling
- UV Stabilised for outdoor use
- Self extinguishing / fire resistant
- Temperature range: -15°c to +50°c
- Minimum safety factor of 4:1 allowing for pressure surges



Code	I.D.	O.D	Coil Length
13-WD08	12.5mm (1/2)	18.9 mm	20m/100m
13-WD12	20mm (3/4)	26.6 mm	20m/100m
13-WD16	25mm (1")	34.2 mm	20m/100m
13-WD20	32mm (1.1/4)	43.0 mm	20m/100m
13-WD24	38mm (1.1/2)	49.0 mm	20m/100m

Esdan Estate Washdown is a specially designed hose for washdown of floors. It is also ideal for use as a commercial watering hose, with its tough white ribbed cover for high abrasion resistance and excellent visibility. Estate Washdown is ideal for use in parks, golf courses, bowling greens, sports grounds, mobile sprinklers and all general washdown applications.

Blue Stripe Dairy Washdown Hose

- All Australian made
- For use in dairy environments
- Low temperature flexibility
- Smooth cover for ease of handling
- Metre marked for convenience
- Distinctive blue line for visibility



Code	I.D.	O.D	Coil Length
13-DWD08	12.5mm (1/2)	18.5 mm	20m/100m
13-DWD12	20mm (3/4)	26.1 mm	20m/50m/100m
13-DWD16	25mm (1")	34.0 mm	20m/50m/100m
13-DWD20	32mm (1.1/4)	42.0 mm	20m/40m/100m
13-DWD24	38mm (1.1/2)	49.9 mm	20m/40m/100m

A smooth, easy to handle flexible premium wash down hose designed for use in dairy wash down sheds. The hose has been designed for the dairy industry, where the hose is used to wash down floors, and come into contact with animal fats. Also suitable for most other wash down applications in nurseries, golf courses and paper mills.

PVC Hose (Category 13)

Hot Wash Hose

- All Australian made
- Tough, high abrasion resistant cover
- Bright white cover for high visibility
- Good flexibility for ease of handling
- UV Stabilised for outdoor use
- Self extinguishing
- Temperature range: up to +80°C
- Minimum safety factor of 4:1 allowing for pressure surges.



Washing Machine / Dishwasher Hose

Code	I.D.	O.D	Coil Length
13-HW08	12.5mm (1/2)	18.9 mm	20m/100m
13-HW12	20mm (3/4)	28.0 mm	20m/100m
13-HW16	25mm (1")	34.2 mm	20m

Esdan Hotwash hose is a Heavy duty outer ribbed hose specifically designed for the conveyance of hot water under pressure. This multi-functional hot water hose can be used in washdown applications and is ideally suited for dish washers and washing machines. The hose has excellent abrasion resistance, is light weight and is U.V. stabilised for outdoor use.

Blue Layflat Hose

ESDAN Blue Layflat PVC hose is designed for light to medium duty water discharge applications in construction, agriculture, general industry and mining. The hose is a strong and economical lightweight hose which lies flat to the ground when not in use and rolls up flat for easy storage. Outlet water pressure is sufficient to open it up to deliver pumped water to exactly where it's required.



Applications include: Water transfer / dewatering / Irrigation sprinklers / sump/trash pumps and Trickle irrigation.

- Construction:** Blue PVC tube and cover are extruded simultaneously to obtain maximum bonding
- Reinforcement:** 3-ply polyester yarn
- Temperature:** -23°C to +65°C (-10°F to +150°F)

Code	I.D.	Working Pressure	Coil Length
13-BLF20	32mm (1.1/4)	70 psi / 482 kpa	100m
13-BLF24	38mm (1.1/2)	70 psi / 482 kpa	100m
13-BLF32	51mm (2")	65 psi / 448 kpa	100m
13-BLF40	65mm (2.1/2)	60 psi / 413 kpa	100m
13-BLF48	76mm (3")	60 psi / 413 kpa	100m
13-BLF64	102mm (4")	60 psi / 413 kpa	100m

Drinking Water Hose

- Australian Made
- No 'plastic' taste in water
- Meets FDA 21 CFR 177
- High quality food grade compound
- Uses standard 12mm hose fittings
- Australian Standard AS 2070



Code	I.D.	O.D	Coil Length	Reel Length
13-DW08	12.5mm (1/2)	16.9 mm	10m/20m/100m	200m

Self Recoil Drinking Water Hose
12mm (1/2) I.D.
10 metre working length.

Fitted with plastic garden hose fittings

Code : 13-DWC08-010FP

Esdan food grade general purpose drinking water hose has been specifically designed for the caravan/motor home / RV market. The tube is flexible and reinforced to withstand normal town and country water pressure. The hose is manufactured from materials meeting USA FDA requirements. Ideal for camping, farms, tanks, aquariums and boating applications. And anywhere that requires safe and clean transfer of drinking water.

Working Pressure 232 psi (1600 kpa)
Burst Pressure 928 psi (6400 kpa)

PVC Hose (Category 13)

Low Pressure L.P.G. Hose

- All Australian made
- Meets AS 1869/C Australian Standard
- Bright orange colour
- U.V protected
- Fully reinforced double wall
- Excellent flexibility



Code	I.D.	O.D	Working Pressure @23°C	Burst Pressure @23°C	Coil Length	Reel Length
13-LPG05	5mm (3/16)	12.5 mm	377 psi / 2600 kpa	1508 psi / 10400 kpa	20m/100m	300m
13-LPG06	6.3mm (1/4)	13.8 mm	377 psi / 2600 kpa	1508 psi / 10400 kpa	20m/100m	300m
13-LPG08	8mm (5/16)	15.5 mm	377 psi / 2600 kpa	1508 psi / 10400 kpa	20m/100m	300m

The Esdan low pressure LPG gas hose is designed for low pressure gas use such as barbecue gas bottle connections between the bottle and the barbecue. The hose has excellent outdoor characteristics and the outer cover is pin-pricked to prevent ballooning in the sun.

Air Seeder Hose

Esdan Clear Air Seeder is a PVC suction and discharge hose with a smooth bore, suitable for use as primary, secondary and tertiary lines on air seeder machines. Lightweight and flexible, Esdan Plastics air seeder hose is also suitable for many other less demanding applications. The hose is clear with a black Spiral, perfect for using in applications where the material being conveyed needs to be seen.



Code	I.D.	O.D	Bend Radius	Working Pressure	Vacuum Rating	Coil Length
13-AS16	25mm (1")	32mm	140mm (5.5")	90 psi / 620 kpa	24 inHg	20m
13-AS20	32mm (1.1/4)	39mm	160mm (6.3")	90 psi / 620 kpa	24 inHg	20m
13-AS24	38mm (1.1/2)	45mm	190mm (7.5")	70 psi / 482 kpa	24 inHg	20m
13-AS28	44mm (1.3/4)	51mm	235mm (9.2")	70 psi / 482 kpa	24 inHg	20m
13-AS32	51mm (2")	59mm	250mm (9.8")	70 psi / 482 kpa	24 inHg	20m
13-AS40	63mm (2.1/2)	73mm	315mm (12.4")	70 psi / 482 kpa	24 inHg	20m
13-AS48	76mm (3")	87mm	375mm (14.8")	70 psi / 482 kpa	24 inHg	20m

For use in Vacuum cleaning, Water Conveyance, Air Conveyance, Slurry and Sludge Transfer, Gravity Feed, Exhaust Removal, Dust Extraction, Air Seeding, Irrigation, and many other applications suitable to a light weight highly flexible hose. Resistant to crushing. Abrasion and weather resistant. Shock resistant PVC spiral.

Blue Nitrile / PVC Suction Hose

Esdan Blue Nitrile/PVC Suction hose is a general purpose strong, flexible & smooth plasticized PVC hose. Lightly corrugated on the outside, it is reinforced with a continuous high impact PVC helix. It is ideal for use in medium duty suction and delivery of water, salt water, light chemical and liquids. It is also suitable for use in agricultural and industrial applications and constructions. Resistant to crushing, abrasion and weather resistant.



	Code	I.D.	O.D	Bend Radius	Working Pressure	Vacuum Rating	Coil Length
<ul style="list-style-type: none"> • Blue specially compounded oil resistant PVC w/rigid PVC helix • Resistance to crushing & abrasion • UV stabilised & weather resistant • Smooth bore • Temp range: 0.5°C to +60°C • Designed to handle light oils and animal fats 	13-BS16	25mm (1")	32mm	140mm (5.5")	85 psi / 585 kpa	29.8 inHg	20m
	13-BS20	32mm (1.1/4)	39mm	160mm (6.3")	80 psi / 550 kpa	29.8 inHg	20m
	13-BS24	38mm (1.1/2)	45mm	190mm (7.5")	75 psi / 516 kpa	29.8 inHg	20m
	13-BS32	51mm (2")	59mm	250mm (9.8")	75 psi / 516 kpa	29.8 inHg	20m
	13-BS40	63mm (2.1/2)	73mm	315mm (12.4")	75 psi / 516 kpa	29.8 inHg	20m
	13-BS48	76mm (3")	87mm	375mm (14.8")	65 psi / 448 kpa	29.8 inHg	20m
	13-BS64	102mm (4")	116mm	500mm (19.7")	55 psi / 380 kpa	29.8 inHg	20m

PVC Hose (Category 13)

Steel Wire Helix Suction Hose

- Clear Non Toxic
- FDA Compliant
- Light and Flexible



Code	I.D.	O.D	Bend Radius	Working Pressure	Vacuum Rating	Coil Length
13-SWHS08	12.5mm (1/2)	20mm	51mm (2")	100 psi / 690 kpa	29 inHg	30m
13-SWHS10	16mm (5/8)	25mm	63mm (2.5")	100 psi / 690 kpa	29 inHg	30m
13-SWHS12	20mm (3/4)	26mm	76mm (3")	70 psi / 480 kpa	29 inHg	30m
13-SWHS16	25mm (1")	33mm	102mm (4")	70 psi / 480 kpa	29 inHg	30m
13-SWHS20	32mm (1.1/4)	41mm	127mm (5")	70 psi / 480 kpa	29 inHg	30m
13-SWHS24	38mm (1.1/2)	47mm	152mm (6")	50 psi / 345 kpa	29 inHg	30m
13-SWHS32	51mm (2")	61mm	203mm (8")	50 psi / 345 kpa	29 inHg	30m

A flexible, heavy duty food grade PVC suction hose, specifically designed for the food and beverage dispensing industry. Ideal for use in abattoirs, canneries etc... The steel wire helix provides full suction capability. The crystal clear wall allows visual confirmation of product flow. The hose is manufactured from a non-toxic formulation conforming to FDA requirements.

Lightweight and flexible, the Esdan Plastics steel helix is also suitable for many other less demanding applications.

Construction: Clear non-toxic PVC w/rigid steel wire helix. FDA compliant

Temperature: +5°C to +65°C

Grey Suction Hose



- High impact PVC helix reinforcement
- Resistant to crushing & abrasion
- UV Stabilised & Weather resistant
- Smooth bore
- Excellent flow characteristics
- Temperature range: 0.5°C to +60°C
- Suitable for liquid, powder & granular materials

Code	I.D.	O.D	Bend Radius	Working Pressure	Vacuum Rating	Coil Length
13-GRS16	25mm (1")	32mm	140mm (5.5")	90 psi / 620 kpa	26 inHg	20m
13-GRS20	32mm (1.1/4)	39mm	160mm (6.3")	90 psi / 620 kpa	26 inHg	20m
13-GRS24	38mm (1.1/2)	45mm	190mm (7.5")	70 psi / 482 kpa	26 inHg	20m
13-GRS32	51mm (2")	59mm	250mm (9.8")	70 psi / 482 kpa	26 inHg	20m
13-GRS40	63mm (2.1/2)	73mm	315mm (12.4")	70 psi / 482 kpa	23 inHg	20m
13-GRS48	76mm (3")	87mm	375mm (14.8")	70 psi / 482 kpa	23 inHg	10m/20m
13-GRS64	102mm (4")	116mm	500mm (19.7")	60 psi / 413 kpa	23 inHg	20m
13-GRS80	127mm (5")	142mm	625mm (24.6")	60 psi / 413 kpa	23 inHg	20m
13-GRS96	152mm (6")	170mm	850mm (33.5")	60 psi / 413 kpa	23 inHg	20m

Esdan grey Suction and Delivery hose is a general purpose strong, flexible & smooth plasticized PVC hose. Lightly corrugated on the outside, it is reinforced with a continuous high impact PVC helix. It is ideal for use in medium duty suction and delivery of water, salt water, light chemicals and liquids.

Also suitable for use in agricultural and industrial applications and constructions.

Resistant to crushing. Abrasion and weather resistant.

PVC Hose (Category 13)

Multi-Flex Hose

- Black PVC hose with a rigid PVC helix
- Excellent flexibility
- Applications:
 - Discharge hose for Bilge pumps
 - Dust extraction ducting
 - Cable conduit
 - Marine use
 - Caravan
 - Ponds



The Esdan Multi-Flex is light weight and flexible with kink and crush resistance and is also particularly effective in the harsh sea water environment of ocean going vessels. The Multi-Flex Hose is ideal for supplying water, oil based liquids and chemical agents. The hose is reinforced with a PVC spiral helix which gives it a corrugated external finish with a smooth bore.

With its light weight and excellent flexibility it is suitable as a caravan sullage hose, bilge pump hose, cable protection on outboards, LPG vent hose on LPG conversions and an air seeder hose.



Code	I.D.	O.D	Bend Radius	Working Pressure	Vacuum Rating	Coil Length
13-MF12	20mm (3/4)	25mm	90mm	40 psi / 275 kpa	14.4 inHg	20m
13-MF16	25mm (1")	31mm	92mm	40 psi / 275 kpa	14.4 inHg	10m/20m
13-MF18	28mm (1.1/8)	34mm	105mm	32 psi / 220 kpa	14.4 inHg	10m/20m
13-MF20	32mm (1.1/4)	38mm	114mm	24 psi / 165 kpa	14.4 inHg	10m/20m
13-MF24	38mm (1.1/2)	46mm	135mm	24 psi / 165 kpa	14.4 inHg	20m
13-MF32	51mm (2")	58mm	176mm	24 psi / 165 kpa	11.5 inHg	10m/20m/40m

Barflo Industrial Hose

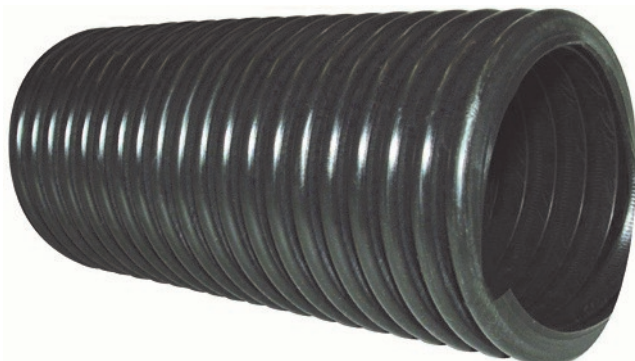

Barflo Industrial is a lightweight, flexible U.V. stabilised air seeder hose. It is also suitable for many other less demanding applications such as air and water conveyance.

Code	I.D.	O.D	Bend Radius	Coil Length
13-BFI08	12.5mm (1/2)	18.9mm	50mm	20m
13-BFI10	16mm (5/8)	21.3mm	65mm	20m
13-BFI12	19mm (3/4)	26.0mm	65mm	20m
13-BFI16	25mm (1")	32mm	70mm	20m
13-BFI18	28mm (1.1/8)	35.3mm	80mm	20m
13-BFI20	32mm (1.1/4)	41.0mm	90mm	20m
13-BFI22	35mm (1.3/8)	45.0mm	90mm	20m
13-BFI24	38mm (1.1/2)	47.3mm	100mm	20m
13-BFI28	44mm (1.3/4)	53.8mm	110mm	20m
13-BFI32	51mm (2")	63.3mm	125mm	20m
13-BFI40	63.5mm (2.1/2)	74.3mm	200mm	20m
13-BFI48	76mm (3")	87.8mm	250mm	20m
13-BFI64	102mm (4")	114.3mm	400mm	20m

Note : 1/2 and 5/8 are grey coloured. All other sizes are black

Split Corrugated Tube

- Made in Australia
- Manufactured from flame retardant polypropylene.
- Self extinguishing when set alight.
- Springs back when opened making sure your cable or hoses remain where you want them - inside the tubing.
- Temperature rating : -20 to +90 °C
- UV Stabilised

Code	I.D.	Thickness	Length
13-CST07-400	7mm	0.25mm	400m
13-CST10-250	9.7mm	0.30mm	250m
13-CST13-150	12.8mm	0.30mm	150m
13-CST16-100	16.3mm	0.30mm	100m
13-CST20-100	21.5mm	0.30mm	100m
13-CST23-050	23mm	0.35mm	50m
13-CST29-050	29mm	0.35mm	50m
13-CST36-025	36mm	0.40mm	25m
13-CST48-025	48mm	0.40mm	25m



NYLON TUBE - INDUSTRIAL (Category 14)



Esdan Nylon Pressure tubing is made from high quality nylon. It has an excellent dimensional stability, is light and saves as much as 75% in weight over rubber hoses & steel lines. Esdan Nylon is used as a standard by many large original equipment manufacturers and industrial users in a wide range of applications. All pressure tubes are temperature & light stabilised. Esdan Nylon is highly resistant to corrosion and heat aging. It also fully resists gasoline, diesel, fuel, oil, grease, brake fluids and other chemicals. Esdan Nylon is easy to install, the tubing can be routed inside frame rails, around corners in continuous length, thus reducing the number of couplings.

Imperial Tube Sizes

Code	Size		Burst Pressure		Working Pressure		Available Lengths	Available Colours	Insert Code
	O.D.	I.D.	PSI	kPa	PSI	kPa			
14-N1102	1/8	0.087	1000	6890	250	1723	20,50,100m	Black, Natural, Blue, Red, Grn, Yel	0199-02
14-N1103	3/16	0.125	1000	6890	250	1723	20,50,100m	Black, Natural, Blue, Red, Grn, Yel	0199-03
14-N1104	1/4	0.169	1000	6890	250	1723	20,50,100m	Black, Natural, Blue, Red, Grn, Yel	0199-04
14-N1105	5/16	0.214	1000	6890	250	1723	20,50,100m	Black, Natural, Blue, Red, Grn, Yel	0199-05
14-N1106	3/8	0.258	1000	6890	250	1723	20,50,100m	Black, Natural, Blue, Red, Grn, Yel	0199-06
14-N1108	1/2	0.347	1000	6890	250	1723	20,50,100m	Black, Natural, Blue, Red, Grn, Yel	0199-08
14-N1110	5/8	0.495	500	3445	125	861	20,50,100m	Black, Natural	0199-10
14-N1112	3/4	0.590	500	3445	125	861	20,50,100m	Black, Natural	0199-12

Metric Tube Sizes

Code	Size		Burst Pressure		Working Pressure		Available Lengths	Available Colours	Insert Code
	O.D.	I.D.	PSI	kPa	PSI	kPa			
14-NM1104	4mm	2.7mm	1000	6890	250	1723	20,50,100m	Blk, Nat, Blue, Red, Grn, Yel	32-M9904
14-NM1105	5mm	3.3mm	1000	6890	250	1723	20,50,100m	Blk, Nat, Blue, Red, Yel	32-M9905
14-NM1106	6mm	4mm	1000	6890	250	1723	20,50,100m	Blk, Nat, Blue, Red, Grn, Yel	32-M9906
14-NM1108	8mm	5.2mm	1000	6890	250	1723	20,50,100m	Blk, Nat, Blue, Red, Grn, Yel	32-M9908
14-NM1110	10mm	6.6mm	1000	6890	250	1723	20,50,100m	Blk, Nat, Blue, Red, Grn, Yel	32-M9910
14-NM1112	12mm	8mm	1000	6890	250	1723	20,50,100m	Blk, Nat, Blue, Red, Grn, Yel	32-M9912
14-NM1114	14mm	10.5mm	1000	6890	250	1723	20,50,100m	Black	

Larger reel sizes may be available. Please contact the sales team with your requirements

NYLON TUBE - SEMI RIGID INDUSTRIAL (Category 14)



Semi Rigid Tube is a higher pressure tube typically used for lubrication applications. It is made from high quality nylon and has an excellent dimensional stability, is light and saves as much as 75% in weight over rubber hoses & steel lines. Esdan Nylon is used as a standard by many large original equipment manufacturers and industrial users in a wide range of applications. All pressure tubes are temperature & light stabilised. Esdan Nylon is highly resistant to corrosion and heat aging. It also fully resists gasoline, diesel, fuel, oil, grease, brake fluids and other chemicals.

Code	Size		Burst Pressure		Working Pressure		Available Lengths	Available Colours	Insert Code
	O.D.	I.D.	PSI	kPa	PSI	kPa			
14-NSR02	1/8	0.078	2500	17225	625	4306	20,50,100m	Black, Natural	0199NSR-02
14-NSR03	3/16	0.110	2500	17225	625	4306	20,50,100m	Black, Natural	0199NSR-03
14-NSR04	1/4	0.147	2500	17225	625	4306	20,50,100m	Black	0199NSR-04
14-NSR05	5/16	0.186	2500	17225	625	4306	20,50,100m	Black, Natural	0199NSR-05
14-NSR06	3/8	0.224	2500	17225	625	4306	20,50,100m	Black, Natural	0199NSR-06
14-NSR08	1/2	0.303	2500	17225	625	4306	20,50,100m	Black, Natural	0199NSR-08
14-NMSR04	4mm	2.4mm	2500	17225	625	4306	20,50,100m	Black, Natural	
14-NMSR06	6mm	3.5mm	2500	17225	625	4306	20,50,100m	Black, Natural	

NYLON AIR BRAKE TUBE - (Category 14)



Esdan Air brake tubing is manufactured from nylon (polyamide) to meet requirements of SAE J844 and DOT FMVSS 571.106 specifications. It is developed specifically for air brake applications but can also be used in a wide range of instrumentation and air systems. Type A tubes are of single wall construction. Type B tubes have a double wall construction with a nylon core, synthetic fibre braid and a nylon cover. It is manufactured out of heat and light stabilized nylon, has good flexibility and a wide range of operating temperatures -40°F to +200°F (-40°C to +80°C)

J844A Single Wall Airbrake Tube

Code	Size		Burst Pressure		Working Pressure		Available Lengths	Available Colours	Insert Code
	O.D.	I.D.	PSI	kPa	PSI	kPa			
14-SWJ02	1/8	0.078	1000	6900	150	1000	25,100m	Black, Blue, Red	34-99JA02
14-SWJ025	5/32	0.092	1200	8300	150	1000	100m	Black, Blue, Red, Green, Yellow	
14-SWJ03	3/16	0.117	1200	8300	150	1000	50,100m	Black, Blue, Red, Green	
14-SWJ04	1/4	0.170	1200	8300	150	1000	25,50,100m	Blk, Blue, Red, Grn, Yel, Orange	34-99JA04
14-SWJ05	5/16	0.232	1000	6900	150	1000	25,50,100m	Black, Blue, Red	34-99JA05

J844B Braided Imperial Airbrake Tube

Code	Size		Burst Pressure		Working Pressure		Available Lengths	Available Colours	Insert Code
	O.D.	I.D.	PSI	kPa	PSI	kPa			
14-BR06	3/8	0.251	1410	9700	150	1000	25,50,100,250m	Black, Blue, Red, Green, Yel	34-99JB06
14-BR08	1/2	0.376	960	6600	150	1000	25,50,100,250m	Black, Blue, Red, Green, Yel	34-99JB08
14-BR10	5/8	0.441	900	6200	150	1000	25,50,100m	Black, Blue, Red, Green	34-99JB10
14-BR12	3/4	0.566	800	5500	150	1000	25,50,100m	Black, Blue, Red, Green	34-99JB12

DIN74324 /J844A Metric Single Wall Airbrake Tube

Code	Size		Burst Pressure		Working Pressure		Available Lengths	Available Colours	Insert Code
	O.D.	I.D.	PSI	kPa	PSI	kPa			
14-SWM04	4mm	2mm	1200	8300	150	1000	25,50,100m	Black	
14-SWM06	6mm	4mm	1200	8300	150	1000	25,50,100m	Black, Blue, Red, Green	34-99DS06
14-SWM08	8mm	6mm	1000	6900	150	1000	25,50,100m	Black, Blue, Red	34-99DS08
14-SWM10075	10mm	7.5mm	Note : Burst pressures are not required for DIN standard Tube. The first 3 sizes above are J844A pressure ratings.		275	1900	25,50,100m	Black, Blue, Red	34-99DS10
14-SWM1008	10mm	8mm			220	1500	100m	Black	
14-SWM12	12mm	9mm			275	1900	25,50,100m	Black, Blue, Red	34-99DS12
14-SWM14	14mm	10mm			320	2200	25,50,100m	Black	
14-SWM15	15mm	12mm			220	1500	25,50,100m	Black	34-99DS15
14-SWM16	16mm	12mm			275	1900	25,50,100m	Black	

J844A Braided Metric Airbrake Tube

Code	Size		Burst Pressure		Working Pressure		Available Lengths	Available Colours	Insert Code
	O.D.	I.D.	PSI	kPa	PSI	kPa			
14-BRM10	10mm	7mm	1190	8200	150	1000	25,50,100m	Black, Blue, Red	34-99JMB10
14-BRM12	12mm	9mm	1000	6900	150	1000	25,50,100m	Black, Blue, Red	34-99JMB12
14-BRM16	16mm	12mm	870	6000	150	1000	25,50,100m	Black	34-99JMB16

Note : Some colours of airbrake tube may only be available in 100 metre lengths.

The working pressures listed for Nylon tube are based on an ambient temp of 23°C. Higher temperatures will result in a reduction of pressure rating.

To calculate working pressures at various temperatures, multiply working pressure by factor given in the table.

Temperature	Factor
-40°C to 23°C	1.00
30°C	0.84
50°C	0.63
60°C	0.56
80°C	0.45

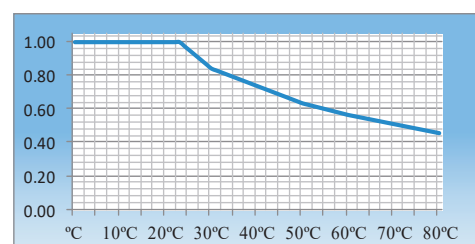

TRUCK COILS - (Category 14)

Suzi-Coils



Code	Description	W/Length
14-SUZI	1/2 Red/Blue J844B Fitted Set. Short Tail	3.0m
14-SUZI-L	1/2 Red/Blue J844BFitted Set. Long Tail	3.7m
14-SUZI-LB	1/2 Unfitted J844B Blue Suzi Coil - Long Tail	3.7m
14-SUZI-LK	1/2 Unfitted J844B Black Suzi Coil - Long Tail	3.7m
14-SUZI-LR	1/2 Unfitted J844B Red Suzi Coil - Long Tail	3.7m
14-SUZI-SB	1/2 Unfitted J844B Blue Suzi Coil - Short Tail	3.0m
14-SUZI-SR	1/2 Unfitted J844B Red Suzi Coil - Short Tail	3.0m
14-SUZI END M8	1/2 Suzi Coil End With Short Springs	N/A
14-BR06C015	3/8 Black J844B Coiled Tube. 15m Working Length	15.0m
14-BR06C015B	3/8 Blue J844B Coiled Tube. 15m Working Length	15.0m
14-BR06C015R	3/8 Red J844B Coiled Tube. 15m Working Length	15.0m
14-BR06C020	3/8 Black J844B Coiled Tube. 20m Working Length	20.0m
14-BR08C015	1/2 Black J844B Coiled Tube. 15m Working Length	15.0m
14-BR08C015B	1/2 Blue J844B Coiled Tube. 15m Working Length	15.0m
14-BR08C015R	1/2 Red J844B Coiled Tube. 15m Working Length	15.0m
14-BR08C020	1/2 Black J844B Coiled Tube. 20m Working Length	20.0m
14-BR08C020B	30m 1/2 Blue J844B Coiled Tube. (20m W/Length)	20.0m
14-BR08C020R	30m 1/2 Red J844B Coiled Tube. (20m W/Length)	20.0m

Fitted Air brake coils are SAE J844 compliant nylon tubing that is helically coiled to give a desired working length. They can be retracted to a very short length and stored out of the way when not in use. They are designed for the transfer of air between the prime mover and semi-trailer.

Fitted Electrocoils



Code	Description
14-EF15	Fitted Electrcoil. 15 Amp. Short Tail
14-EF15-L	Fitted Electrcoil. 15 Amp. Long Tail
14-EF35	Fitted Electrcoil. 35 Amp. Short Tail
14-EF35-L	Fitted Electrcoil. 35 Amp. Long Tail

15 Amp coils are 7 core polyamide coated. Wiring is 6 cores of 4mm (2mm²) cable and one 5mm (3mm²) earth cable.

Very good abrasion and sag resistance and UV protection.

Each coils extends to 4.6m (15ft).

Each coil is fitted with standard large round 7 pin metal trailer plugs with Amp rating per pole of 30A at 12 Volts.

Accepts 6mm cable (5.22mm²)

Heavy Duty 35 Amp Coils are 7 core polyamide coated. Wiring is 4 x 5mm (3mm²), 2 x 6mm (5mm²) and 1 x 8AWG (8mm²). The heavy duty green jacket offers very good abrasion and sag resistance and UV protection.

Each coils extends to 4.6m (15ft).

Each coil is fitted with heavy duty 7 pin metal trailer plugs with an internal weatherproof seal and cable guard.

Amp rating per pole of 30A at 6-24 Volts continuous

Unfitted Electrocoils



Code	Description	W/Length
14-ELEC15	Standard Duty 15 Amp 7 Core Electracoil Short Tail	3.0m
14-ELEC15-L	Standard Duty 15 Amp 7 Core Electracoil Long Tail	3.5m
14-ETTEC15X10M	Light Duty 15 Amp 7 Core Electracoil 10m Long	10.0m
14-ELEC25	Heavy Duty 25 Amp 7 Core Electracoil Short Tail	3.0m
14-ELEC25-L	Heavy Duty 25 Amp 7 Core Electracoil Long Tail	3.5m

POLYURETHANE TUBE (Category 14)



Polyurethane tubing is lightweight, extremely flexible and ultra kink resistant. It remains flexible at low temperatures. It is UV stabilised and abrasive resistant.

The tube is manufactured under tight tolerances from as ester based, FDA approved 98A material.

Temperature Range : -20°C to 60°C (-4°F to 140°F)

Imperial Tube Sizes

Code	Size		Burst Pressure		Working Pressure		Available Lengths	Available Colours
	O.D.	I.D.	PSI	kPa	PSI	kPa		
14-PU02	1/8	0.062	720	4960	240	1650	25,100m	Clear
14-PU03	3/16	0.107	495	3410	165	1140	20,50,100m	Black, Blue
14-PU04	1/4	0.160	430	2960	143	990	20,50,100m	Black, Blue, Clear, Red, Yellow
14-PU06	3/8	0.250	396	2730	132	910	20,50,100m	Black, Blue, Clear, Red, Yellow
14-PU08	1/2	0.320	444	3060	148	1020	20,100m	Black, Blue, Clear

Metric Tube Sizes

Code	Size		Burst Pressure		Working Pressure		Available Lengths	Available Colours
	O.D.	I.D.	PSI	kPa	PSI	kPa		
14-PUM03	3mm	1.8mm	570	3900	190	1300	20,50,100m	Blue
14-PUM04	4mm	2.5mm	570	3900	190	1300	20,100,200m	Black, Blue, Clear, Red, Yellow
14-PUM06	6mm	4.0mm	480	3300	160	1100	20,50,100m	Black, Blue, Clear, Red, Yellow, Green
14-PUM08	8mm	5.0mm	520	3600	170	1200	20,50,100m	Black, Blue, Clear, Red, Yellow
14-PUM10	10mm	6.5mm	480	3300	160	1100	20,50,100m	Black, Blue, Clear, Red, Yellow
14-PUM12	12mm	8.0mm	440	3000	150	1000	20,50,100m	Black, Blue, Clear, Red, Yellow
14-PUM16	16mm	11.0mm	440	3000	150	1000	20,50,100m	Black, Blue, Clear

TWIN BONDED POLYURETHANE TUBE (Category 14)



Code	Size		Burst Pressure		Working Pressure		Available Lengths	Available Colours
	O.D.	I.D.	PSI	kPa	PSI	kPa		
14-PUMT06	6mm	4.0mm	480	3300	160	1100	100m	Black/Blue
14-PUMT08	8mm	5.0mm	520	3600	170	1200	100m	Black/Blue
14-PUMT10	10mm	6.5mm	480	3300	160	1100	50m	Black/Blue

The working pressures listed for PU tube are based on an ambient temp of 23°C. Higher temperatures will result in a reduction of pressure rating.

To calculate working pressures at various temperatures, multiply working pressure by factor given in the table below.

Temperature	Factor
-20°C to 20°C	1.00
30°C	0.85
40°C	0.70
50°C	0.60
60°C	0.50



Refer to category 20 for a full range of compatible push-in fittings

PTFE (TEFLON) TUBE (Category 14)



- Manufactured from Virgin Polytetrafluorethylene (PTFE)
- High Operating Temperatures. (-70° to 260°C)
- High Chemical Resistance
- Smooth Bore
- High Flexibility
- Suitable for food, chemical and medical transfer applications
- FDA Approved. PTFE Perfluorocarbon Resins meets FDA 21 CFR 177.1550
- Available in a Natural / Translucent White Colour.

Imperial Tube Sizes

Code	Size		Burst Pressure		Working Pressure		Available Lengths
	O.D.	I.D.	PSI	kpa	PSI	kpa	
14-T0201	1/8 (3.18mm)	1/16 (1.59mm)	1500	10335	375	2584	5m, 25m
14-T0302	3/16 (4.76mm)	1/8 (3.18mm)	962	6625	240	1656	5m, 25m
14-T0403	1/4 (6.35mm)	3/16 (4.76mm)	700	4823	175	1206	5m, 25m
14-T0504	5/16 (7.94mm)	1/4 (6.35mm)	549	3781	137	945	5m, 25m
14-T0604	3/8 (9.53mm)	1/4 (6.35mm)	962	6625	240	1656	5m, 25m
14-T0605	3/8 (9.53mm)	5/16 (7.94mm)	451	3106	113	777	5m, 25m
14-T0806	1/2 (12.7mm)	3/8 (9.53mm)	700	4823	175	1206	5m, 25m
14-T1008	5/8 (15.88mm)	1/2 (12.7mm)	549	3781	137	945	5m, 25m
14-T1210	3/4 (19.05mm)	5/8 (15.88mm)	451	3106	113	777	5m, 25m

Metric Tube Sizes

Code	Size		Burst Pressure		Working Pressure		Available Lengths
	O.D.	I.D.	PSI	kpa	PSI	kpa	
14-TM0402	4mm (0.157)	2mm (0.079)	1500	10335	375	2584	5m, 25m
14-TM0503	5mm (0.197)	3mm (0.118)	1176	8106	294	2026	5m, 25m
14-TM0604	6mm (0.236)	4mm (0.157)	962	6625	240	1656	5m, 25m
14-TM0805	8mm (0.315)	5mm (0.197)	1096	7548	274	1887	5m, 25m
14-TM0806	8mm (0.315)	6mm (0.236)	700	4823	175	1206	5m, 25m
14-TM1008	10mm (0.394)	8mm (0.315)	549	3781	137	945	5m, 25m
14-TM1209	12mm (0.472)	9mm (0.354)	700	4823	175	1206	5m, 25m

The working pressures listed for PTFE tube are based on an ambient temp of 23°C. Higher temperatures will result in a reduction of pressure rating. To calculate working pressures at various temperatures, multiply working pressure by factor given in the table and graph below

Temp	Factor
-60°C	1.00
-30°C	1.00
0°C	1.00
23°C	1.00
50°C	0.82
100°C	0.59
120°C	0.47
150°C	0.35
180°C	0.25
200°C	0.20
220°C	0.16
250°C	0.11
260°C	0.09

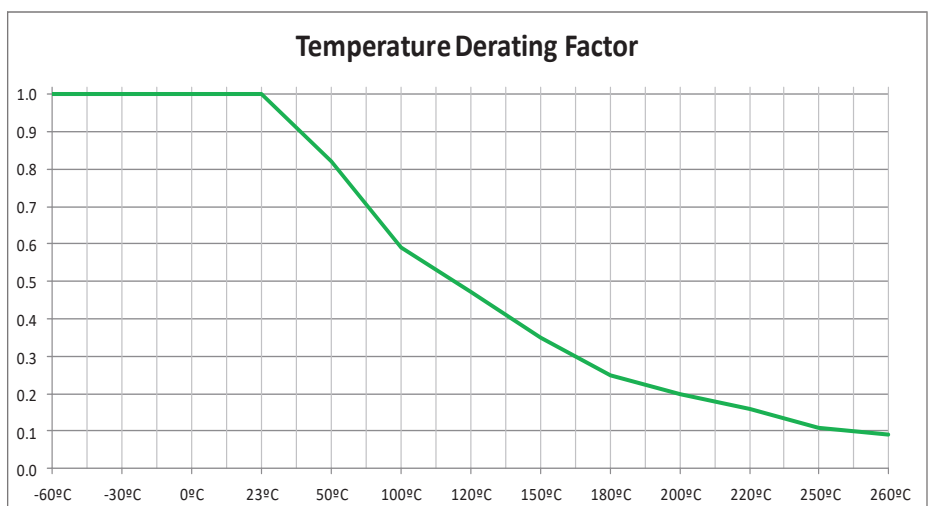

CLEAR SILICONE TUBE (Category 14)

General Characteristics

- Manufactured from 100% platinum silicone elastomer.
- Environmentally friendly.
- Odourless, tasteless and non-toxic.
- Individually sealed and packaged 15 meter coils.
- **F.D.A and European Pharmacopoeia approved.**



Physical Properties

Hardness (durometer)	60 Shore A
Tensile Strength	10.8 Mpa
Elongation at Break	400%
Tear Strength	34 kN/m
Brittle Point	-82°C
Working Temp. Range	-50°C to + 260°C

Typical Applications

- Peristaltic Pumps
- Aspirating
- Suction
- Infusion
- Anaesthetic Machine Circuits
- Food Manufacturing & Processing
- Laboratory and Scientific Equipment

Size Range

Code	O.D.	I.D.	Burst Pressure		Working Pressure		Available Lengths
			PSI	kPa	PSI	kPa	
14-SI047024	1.2mm (0.047")	0.6mm (0.024")					5m, 15m
14-SI063031	1.6mm (1/16)	0.8mm (1/32)					5m, 15m
14-SI087047	2.2mm (0.087")	1.2mm (0.047")					5m, 15m
14-SI094063	2.4mm (3/32)	1.6mm (1.16)					5m, 15m
14-SI125063	3.2mm (1/8)	1.6mm (1.16)					5m, 15m
14-SI193102	4.9mm (0.193")	2.6mm (0.102")	8	55	3	18	5m, 15m
14-SI250125	6.4mm (1.4)	3.2mm (1/8)	18	124	6	41	5m, 15m
14-SI312188	7.9mm (5/16)	4.8mm (3/16)	22	152	7	51	5m, 15m
14-SI375188	9.5mm (3/8)	4.8mm (3/16)	32	220	11	73	5m, 15m
14-SI375250	9.5mm (3/8)	6.4mm (1/4)	22	152	7	51	5m, 15m
14-SI437250	11.1mm (7/16)	6.4mm (1/4)	29	200	10	67	5m, 15m
14-SI469281	11.9mm (15/32)	7.1mm (9/32)	34	234	11	78	5m, 15m
14-SI500250	12.7mm (1/2)	6.4mm (1/4)	45	310	15	103	5m, 15m
14-SI500312	12.7mm (1/2)	7.9mm (5/16)	28	193	9	64	5m, 15m
14-SI563312	14.3mm (9/16)	7.9mm (5/16)	48	331	16	110	5m, 15m
14-SI563375	14.3mm (9/16)	9.5mm (3/8)	21	145	7	48	5m, 15m
14-SI591394	15.0mm (0.591")	10.0mm (0.394")	28	193	9	64	5m, 15m
14-SI625375	15.9mm (5/8)	9.5mm (3/8)	30	207	10	69	5m, 15m
14-SI688500	17.5mm (11/16)	12.7mm (1/2)	16	110	5	37	5m, 15m
14-SI750500	19.1mm (3/4)	12.7mm (1/2)	30	207	10	69	5m, 15m
14-SI875625	22.2mm (7/8)	15.9mm (5/8)	25	172	8	57	5m, 15m

POLYETHYLENE TUBE (LDPE) (Category 14)



Esdan LDPE is ideal for transfer of air & liquids in industrial appliances. It is chemically inert and has excellent resistance to most solvents. LDPE has a wide range of uses in industry, agriculture, chemical plants and paper mills. It provides good resistance to most chemicals. It has an operating temperature range of up to 60°C . LDPE is recommended for pneumatic control installations and low pressure hydraulics where a low cost, flexible connection is required. Esdan LDPE offers sturdy performance. It is lightweight and flexible. LDPE is available in a wide range of colours. All colours other than Yellow are Food Contact to AS 2070

Imperial Tube Sizes

Code	Size		Burst Pressure		Working Pressure		Available Lengths	Available Colours
	O.D.	I.D.	PSI	kPa	PSI	kPa		
14-PE03	3/16	0.124	480	3307	120	827	100m	Black
14-PE04	1/4	0.166	480	3307	120	827	100m	Black, Blue, Natural, Red
14-PE05	5/16	0.208	480	3307	120	827	100m	Black
14-PE06	3/8	0.250	480	3307	120	827	100m	Black, Blue, Natural, Yellow
14-PE08	1/2	0.333	480	3307	120	827	100m	Black, Blue, Natural
14-PE10	5/8	0.500	480	3307	120	827	100m	Black, Natural

Metric Tube Sizes

Code	Size		Burst Pressure		Working Pressure		Available Lengths	Available Colours
	O.D.	I.D.	PSI	kPa	PSI	kPa		
14-PEM04	4mm	2.6mm	464	3200	116	800	100m	Black, Blue, Natural
14-PEM06	6mm	4mm	464	3200	116	800	100m	Black, Blue, Natural, Red
14-PEM08	8mm	5.3mm	464	3200	116	800	100m	Black, Blue, Natural, Red, Yellow
14-PEM10	10mm	6.6mm	464	3200	116	800	100m	Black, Blue, Green, Natural
14-PEM12	12mm	8mm	464	3200	116	800	100m	Black, Blue, Natural

FEP140 TUBE (Category 14)



- Manufactured from Fluorinated Ethylene Propylene (FEP140)
- Operating Temperatures. (-40° to 150°C)
- Resists to most chemicals and solvents
- Suitable for food, chemical and medical transfer applications
- FDA Approved. Meets FDA 21 CFR 177.1550
- UL94 V-0 Fire Resistance
- Available in Clear only for high fluid visibility

Metric Tube Sizes

Code	Size		Working Pressure		Available Lengths
	O.D.	I.D.	PSI	kpa	
14-FEM0402	4mm (0.157)	2.5mm (0.098)	330	2250	5m, 25m
14-FEM0604	6mm (0.236)	4mm (0.157)	290	2000	5m, 25m
14-FEM0806	8mm (0.315)	6mm (0.236)	230	1600	5m, 25m
14-FEM1008	10mm (0.394)	8mm (0.315)	170	1200	5m, 25m
14-FEM1210	12mm (0.472)	10mm (0.394)	140	950	5m, 25m

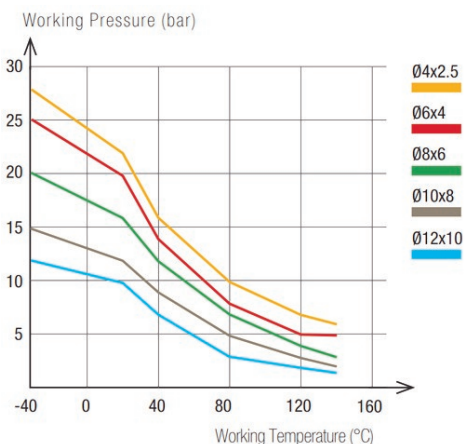

For working pressures at higher temperatures, please see the adjacent graph

CLAW COUPLERS (Category 15)



Female Claw Coupler – Type A

Size	Code
3/8 BSP	15-CCF06
1/2 BSP	15-CCF08
3/4 BSP	15-CCF12
1" BSP	15-CCF16



Hose Claw Coupler – Type A

Size	Code
3/8	15-CCH06
1/2	15-CCH08
3/4	15-CCH12
1"	15-CCH16
1.1/4	15-CCH20



Male Claw Coupler – Type A

Size	Code
3/8 BSP	15-CCM06
1/2 BSP	15-CCM08
3/4 BSP	15-CCM12
1" BSP	15-CCM16
1.1/4 BSP	15-CCM20

NATA STANDARD CAMLOCKS (Category 16)



Female Camlock Adaptor
Type A

Size	Aluminium Code	Polypropylene Code	Stainless Steel Code	Brass Code
1/2 (15mm)	16-AL050A		16-SS050A	16-BR050A
3/4 (20mm)	16-AL075A	16-PP075A	16-SS075A	16-BR075A
3/4x1/2 (17mm)	16-AL075A-050	16-PP075A-050	16-SS075A-050	
1" (25mm)	16-AL100A	16-PP100A	16-SS100A	16-BR100A
1.1/4 (32mm)	16-AL125A	16-PP125A	16-SS125A	16-BR125A
1.1/2 (40mm)	16-AL150A	16-PP150A	16-SS150A	16-BR150A
1.1/2x1.1/4 (35mm)		16-PP150A-125		
2" (50mm)	16-AL200A	16-PP200A	16-SS200A	16-BR200A
2.1/2 (65mm)	16-AL250A	16-PP250A	16-SS250A	16-BR250A
3" (80mm)	16-AL300A	16-PP300A	16-SS300A	16-BR300A
4" (100mm)	16-AL400A	16-PP400A	16-SS400A	16-BR400A
5" (125mm)	16-AL500A			
6" (150mm)	16-AL600A		16-SS600A	16-BR600A



Male Camlock Coupling
Type B

Size	Aluminium Code	Polypropylene Code	Stainless Steel Code	Brass Code
1/2 (15mm)	16-AL050B		16-SS050B	16-BR050B
3/4 (20mm)	16-AL075B	16-PP075B	16-SS075B	16-BR075B
3/4x1/2 (17mm)	16-AL075B-050	16-PP075B-050	16-SS075B-050	
1" (25mm)	16-AL100B	16-PP100B	16-SS100B	16-BR100B
1.1/4 (32mm)	16-AL125B	16-PP125B	16-SS125B	16-BR125B
1.1/2 (40mm)	16-AL150B	16-PP150B	16-SS150B	16-BR150B
1.1/2x1.1/4 (35mm)		16-PP150B-125		
2" (50mm)	16-AL200B	16-PP200B	16-SS200B	16-BR200B
2.1/2 (65mm)	16-AL250B	16-PP250B	16-SS250B	16-BR250B
3" (80mm)	16-AL300B	16-PP300B	16-SS300B	16-BR300B
4" (100mm)	16-AL400B	16-PP400B	16-SS400B	16-BR400B
5" (125mm)	16-AL500B			
6" (150mm)	16-AL600B		16-SS600B	16-BR600B



Hose Camlock Coupling
Type C

Size	Aluminium Code	Polypropylene Code	Stainless Steel Code	Brass Code
1/2 (15mm)	16-AL050C		16-SS050C	16-BR050C
3/4 (20mm)	16-AL075C	16-PP075C	16-SS075C	16-BR075C
3/4x1/2 (17mm)	16-AL075C-050	16-PP075C-050	16-SS075C-050	
1" (25mm)	16-AL100C	16-PP100C	16-SS100C	16-BR100C
1.1/4 (32mm)	16-AL125C	16-PP125C	16-SS125C	16-BR125C
1.1/2 (40mm)	16-AL150C	16-PP150C	16-SS150C	16-BR150C
1.1/2x1.1/4 (35mm)		16-PP150C-125		
2" (50mm)	16-AL200C	16-PP200C	16-SS200C	16-BR200C
2.1/2 (65mm)	16-AL250C	16-PP250C	16-SS250C	16-BR250C
3" (80mm)	16-AL300C	16-PP300C	16-SS300C	16-BR300C
4" (100mm)	16-AL400C	16-PP400C	16-SS400C	16-BR400C
5" (125mm)	16-AL500C			
6" (150mm)	16-AL600C		16-SS600C	16-BR600C

NATA STANDARD CAMLOCKS (Category 16)



Female Camlock Coupling
Type D

Size	Aluminium Code	Polypropylene Code	Stainless Steel Code	Brass Code
1/2 (15mm)	16-AL050D		16-SS050D	16-BR050D
3/4 (20mm)	16-AL075D	16-PP075D	16-SS075D	16-BR075D
3/4x1/2 (17mm)	16-AL075D-050	16-PP075D-050	16-SS075D-050	
1" (25mm)	16-AL100D	16-PP100D	16-SS100D	16-BR100D
1.1/4 (32mm)	16-AL125D	16-PP125D	16-SS125D	16-BR125D
1.1/2 (40mm)	16-AL150D	16-PP150D	16-SS150D	16-BR150D
1.1/2x1.1/4 (35mm)		16-PP150D-125		
2" (50mm)	16-AL200D	16-PP200D	16-SS200D	16-BR200D
2.1/2 (65mm)	16-AL250D	16-PP250D	16-SS250D	16-BR250D
3" (80mm)	16-AL300D	16-PP300D	16-SS300D	16-BR300D
4" (100mm)	16-AL400D	16-PP400D	16-SS400D	16-BR400D
5" (125mm)	16-AL500D			
6" (150mm)	16-AL600D		16-SS600D	16-BR600D



Hose Camlock Adaptor
Type E

Size	Aluminium Code	Polypropylene Code	Stainless Steel Code	Brass Code
1/2 (15mm)	16-AL050E		16-SS050E	16-BR050E
3/4 (20mm)	16-AL075E	16-PP075E	16-SS075E	16-BR075E
3/4x1/2 (17mm)	16-AL075E-050	16-PP075E-050	16-SS075E-050	
1" (25mm)	16-AL100E	16-PP100E	16-SS100E	16-BR100E
1.1/4 (32mm)	16-AL125E	16-PP125E	16-SS125E	16-BR125E
1.1/2 (40mm)	16-AL150E	16-PP150E	16-SS150E	16-BR150E
1.1/2x1.1/4 (35mm)		16-PP150E-125		
2" (50mm)	16-AL200E	16-PP200E	16-SS200E	16-BR200E
2.1/2 (65mm)	16-AL250E	16-PP250E	16-SS250E	16-BR250E
3" (80mm)	16-AL300E	16-PP300E	16-SS300E	16-BR300E
4" (100mm)	16-AL400E	16-PP400E	16-SS400E	16-BR400E
5" (125mm)	16-AL500E			
6" (150mm)	16-AL600E		16-SS600E	16-BR600E



Male Camlock Adaptor
Type F

Size	Aluminium Code	Polypropylene Code	Stainless Steel Code	Brass Code
1/2 (15mm)	16-AL050F		16-SS050F	16-BR050F
3/4 (20mm)	16-AL075F	16-PP075F	16-SS075F	16-BR075F
3/4x1/2 (17mm)	16-AL075F-050	16-PP075F-050	16-SS075F-050	
1" (25mm)	16-AL100F	16-PP100F	16-SS100F	16-BR100F
1.1/4 (32mm)	16-AL125F	16-PP125F	16-SS125F	16-BR125F
1.1/2 (40mm)	16-AL150F	16-PP150F	16-SS150F	16-BR150F
1.1/2x1.1/4 (35mm)		16-PP150F-125		
2" (50mm)	16-AL200F	16-PP200F	16-SS200F	16-BR200F
2.1/2 (65mm)	16-AL250F	16-PP250F	16-SS250F	16-BR250F
3" (80mm)	16-AL300F	16-PP300F	16-SS300F	16-BR300F
4" (100mm)	16-AL400F	16-PP400F	16-SS400F	16-BR400F
5" (125mm)	16-AL500F			
6" (150mm)	16-AL600F		16-SS600F	16-BR600F

NATA STANDARD CAMLOCKS (Category 16)



Camlock Dust Cap
Type DC

Size	Aluminium Code	Polypropylene Code	Stainless Steel Code	Brass Code
1/2 (15mm)	16-AL050DC		16-SS050DC	16-BR050DC
3/4 (20mm)	16-AL075DC	16-PP075DC	16-SS075DC	16-BR075DC
1" (25mm)	16-AL100DC	16-PP100DC	16-SS100DC	16-BR100DC
1.1/4 (32mm)	16-AL125DC	16-PP125DC	16-SS125DC	16-BR125DC
1.1/2 (40mm)	16-AL150DC	16-PP150DC	16-SS150DC	16-BR150DC
2" (50mm)	16-AL200DC	16-PP200DC	16-SS200DC	16-BR200DC
2.1/2 (65mm)	16-AL250DC	16-PP250DC	16-SS250DC	16-BR250DC
3" (80mm)	16-AL300DC	16-PP300DC	16-SS300DC	16-BR300DC
4" (100mm)	16-AL400DC	16-PP400DC	16-SS400DC	16-BR400DC
5" (125mm)	16-AL500DC			
6" (150mm)	16-AL600DC		16-SS600DC	16-BR600DC



Camlock Dust Plug
Type DP

Size	Aluminium Code	Polypropylene Code	Stainless Steel Code	Brass Code
1/2 (15mm)	16-AL050DP		16-SS050DP	16-BR050DP
3/4 (20mm)	16-AL075DP	16-PP075DP	16-SS075DP	16-BR075DP
1" (25mm)	16-AL100DP	16-PP100DP	16-SS100DP	16-BR100DP
1.1/4 (32mm)	16-AL125DP	16-PP125DP	16-SS125DP	16-BR125DP
1.1/2 (40mm)	16-AL150DP	16-PP150DP	16-SS150DP	16-BR150DP
2" (50mm)	16-AL200DP	16-PP200DP	16-SS200DP	16-BR200DP
2.1/2 (65mm)	16-AL250DP	16-PP250DP	16-SS250DP	16-BR250DP
3" (80mm)	16-AL300DP	16-PP300DP	16-SS300DP	16-BR300DP
4" (100mm)	16-AL400DP	16-PP400DP	16-SS400DP	16-BR400DP
5" (125mm)	16-AL500DP			
6" (150mm)	16-AL600DP		16-SS600DP	16-BR600DP



Buna N Camlock Seals

Size	Code	Approximate Dimensions
1/2 (15mm)	16-W050BU	26x16x4mm
3/4 (20mm)	16-W075BU	35x23x5mm
1" (25mm)	16-W100BU	40x26x6mm
1.1/4 (32mm)	16-W125BU	50x34x6mm
1.1/2 (40mm)	16-W150BU	55x41x6mm
2" (50mm)	16-W200BU	66x50x6mm
2.1/2 (65mm)	16-W250BU	79x60x6mm
3" (80mm)	16-W300BU	95x76x6mm
4" (100mm)	16-W400BU	124x120x6mm
6" (150mm)	16-W600BU	180x152x6mm

Camlock Finger Ring



Code : 16-CFR



We also stock a large range of hose clamps. Refer to Category 50 for further details or contact the sales team

Phone (03) 8770 1333 Fax (03) 8770 1313
 Email : sales@ifsvic.com.au
 Web Site : www.ifsvic.com.au



STANDARD BRASS - BSP Plumbing Screwed Fittings. (Category 17)



#24P
Reducing
Bush

Code	Male	Female
17-024-0804	1/2 BSP	1/4 BSP
17-024-0806	1/2 BSP	3/8 BSP
17-024-1208	3/4 BSP	1/2 BSP
17-024-1608	1" BSP	1/2 BSP
17-024-1612	1" BSP	3/4 BSP
17-024-2008	1.1/4 BSP	1/2 BSP
17-024-2012	1.1/4 BSP	3/4 BSP
17-024-2016	1.1/4 BSP	1" BSP
17-024-2408	1.1/2 BSP	1/2 BSP
17-024-2412	1.1/2 BSP	3/4 BSP
17-024-2416	1.1/2 BSP	1" BSP
17-024-2420	1.1/2 BSP	1.1/4 BSP
17-024-3208	2" BSP	1/2 BSP
17-024-3212	2" BSP	3/4 BSP
17-024-3216	2" BSP	1" BSP
17-024-3220	2" BSP	1.1/4 BSP
17-024-3224	2" BSP	1.1/2 BSP
17-024-4032	2.1/2 BSP	2" BSP
17-024-4832	3" BSP	2" BSP
17-024-4840	3" BSP	2.1/2 BSP
17-024-6432	4" BSP	2" BSP
17-024-6440	4" BSP	2.1/2 BSP
17-024-6448	4" BSP	3" BSP



#25P
M&F
Elbow

Code	Male	Female
17-025-08	1/2 BSP	1/2 BSP
17-025-12	3/4 BSP	3/4 BSP
17-025-16	1" BSP	1" BSP
17-025-20	1.1/4 BSP	1.1/4 BSP
17-025-24	1.1/2 BSP	1.1/2 BSP
17-025-32	2" BSP	2" BSP



#26P
Hex
Socket

Code	Female
17-026-08	1/2 BSP
17-026-12	3/4 BSP
17-026-16	1" BSP
17-026-20	1.1/4 BSP
17-026-24	1.1/2 BSP
17-026-32	2" BSP
17-026-40	2.1/2 BSP
17-026-48	3" BSP
17-026-64	4" BSP

Most fittings in this category are available chrome plated. Please contact the sales office for further details.



#27P
Hex
Nipple

Code	Male
17-027-08	1/2 BSP
17-027-12	3/4 BSP
17-027-16	1" BSP
17-027-20	1.1/4 BSP
17-027-24	1.1/2 BSP
17-027-32	2" BSP
17-027-40	2.1/2 BSP
17-027-48	3" BSP
17-027-64	4" BSP



#27BP
Butt
Nipple

Code	Male
17-027B-02	1/8 BSP
17-027B-04	1/4 BSP
17-027B-06	3/8 BSP
17-027B-08	1/2 BSP
17-027B-12	3/4 BSP
17-027B-16	1" BSP
17-027B-20	1.1/4 BSP
17-027B-24	1.1/2 BSP
17-027B-32	2" BSP



#29P
Reducing
Socket

Code	Female	Female
17-029-2008	1.1/4 BSP	1/2 BSP
17-029-2012	1.1/4 BSP	3/4 BSP
17-029-2016	1.1/4 BSP	1" BSP
17-029-2416	1.1/2 BSP	1" BSP
17-029-2420	1.1/2 BSP	1.1/4 BSP
17-029-3216	2" BSP	1" BSP
17-029-3220	2" BSP	1.1/4 BSP
17-029-3224	2" BSP	1.1/2 BSP
17-029-4020	2.1/2 BSP	1.1/4 BSP
17-029-4024	2.1/2 BSP	1.1/2 BSP
17-029-4032	2.1/2 BSP	2" BSP



#33P
Hex
Cap

Code	Male
17-033-20	1.1/4 BSP
17-033-24	1.1/2 BSP
17-033-32	2" BSP
17-033-40	2.1/2 BSP
17-033-48	3" BSP
17-033-64	4" BSP



#28P
Allthread
Nipple

Code	Male	Length
17-028-0206	1/8 BSP	6"
17-028-0406	1/4 BSP	6"
17-028-0412	1/4 BSP	12"
17-028-0606	3/8 BSP	6"
17-028-0612	3/8 BSP	12"
17-028-08015	1/2 BSP	1.1/2
17-028-0802	1/2 BSP	2"
17-028-0803	1/2 BSP	3"
17-028-0804	1/2 BSP	4"
17-028-0806	1/2 BSP	6"
17-028-0812	1/2 BSP	12"
17-028-0824	1/2 BSP	24"
17-028-1202	3/4 BSP	2"
17-028-1203	3/4 BSP	3"
17-028-1206	3/4 BSP	6"
17-028-1212	3/4 BSP	12"
17-028-1604	1" BSP	4"
17-028-1606	1" BSP	6"
17-028-1612	1" BSP	12"
17-028-2006	1.1/4 BSP	6"
17-028-2012	1.1/4 BSP	12"
17-028-2406	1.1/2 BSP	6"
17-028-2412	1.1/2 BSP	12"
17-028-3206	2" BSP	6"
17-028-3212	2" BSP	12"
17-028-4809	3" BSP	9"



#34P
Female
Elbow

Code	Female	Female
17-034-08	1/2 BSP	1/2 BSP
17-034-12	3/4 BSP	3/4 BSP
17-034-16	1" BSP	1" BSP
17-034-20	1.1/4 BSP	1.1/4 BSP
17-034-24	1.1/2 BSP	1.1/2 BSP
17-034-32	2" BSP	2" BSP
17-034-40	2.1/2 BSP	2.1/2 BSP
17-034-48	3" BSP	3" BSP



#34PR
Reducing
Female Elbow

Code	Female	Female
17-034R-1208	3/4 BSP	1/2 BSP
17-034R-1612	1" BSP	3/4 BSP

PRESSURE: Low pressure ratings around 700kpa/100psi decreasing as sizes increase and depending on the medium.

TEMPERATURE: 0°C to 120°C

STANDARD BRASS - BSP Plumbing Screwed Fittings. (Category 17)



#35P
Female
Tee

Code	Female
17-035-08	1/2 BSP
17-035-12	3/4 BSP
17-035-16	1" BSP
17-035-20	1.1/4 BSP
17-035-24	1.1/2 BSP
17-035-32	2" BSP
17-035-40	2.1/2 BSP
17-035-48	3" BSP



#35PR
Reducing
Female Tee

Code	Female	Female
17-035R-1208	3/4 BSP	1/2 BSP



#48PR
Reducing
Male Tee

Code	Male	Male
17-048R-1208	3/4 BSP	1/2 BSP



#64P
Hex
Plug

Code	Female
17-064-08	1/2 BSP
17-064-10	5/8 BSP
17-064-12	3/4 BSP
17-064-16	1" BSP
17-064-20	1.1/4 BSP
17-064-24	1.1/2 BSP
17-064-32	2" BSP
17-064-40	2.1/2 BSP
17-064-48	3" BSP
17-064-64	4" BSP



#72PL
Extended
M&F Adaptor

Code	Thread	Length
17-072L-08015	1/2 BSP	1.1/2
17-072L-0802	1/2 BSP	2"
17-072L-08025	1/2 BSP	2.1/2
17-072L-0803	1/2 BSP	3"
17-072L-0804	1/2 BSP	4"
17-072L-0805	1/2 BSP	5"
17-072L-0806	1/2 BSP	6"



#72P
M&F
Adaptor

Code	Female	Male
17-072-0808	1/2 BSP	1/2 BSP
17-072-1208	3/4 BSP	1/2 BSP
17-072-1212	3/4 BSP	3/4 BSP
17-072-1608	1" BSP	1/2 BSP
17-072-1612	1" BSP	3/4 BSP
17-072-1616	1" BSP	1" BSP
17-072-2012	1.1/4 BSP	3/4 BSP
17-072-2016	1.1/4 BSP	1" BSP
17-072-2020	1.1/4 BSP	1.1/4 BSP
17-072-2416	1.1/2 BSP	1" BSP
17-072-2420	1.1/2 BSP	1.1/4 BSP
17-072-2424	1.1/2 BSP	1.1/2 BSP
17-072-3216	2" BSP	1" BSP
17-072-3220	2" BSP	1.1/4 BSP
17-072-3224	2" BSP	1.1/2 BSP
17-072-3232	2" BSP	2" BSP
17-072-4032	2.1/2 BSP	2" BSP
17-072-4832	3" BSP	2" BSP
17-072-4840	3" BSP	2.1/2 BSP



#73P
Reducing
Nipple

Code	Male	Male
17-073-0804	1/2 BSP	1/4 BSP
17-073-0806	1/2 BSP	3/8 BSP
17-073-1206	3/4 BSP	3/8 BSP
17-073-1208	3/4 BSP	1/2 BSP
17-073-1608	1" BSP	1/2 BSP
17-073-1612	1" BSP	3/4 BSP
17-073-2012	1.1/4 BSP	3/4 BSP
17-073-2016	1.1/4 BSP	1" BSP
17-073-2416	1.1/2 BSP	1" BSP
17-073-2420	1.1/2 BSP	1.1/4 BSP
17-073-3220	2" BSP	1.1/4 BSP
17-073-3224	2" BSP	1.1/2 BSP
17-073-4032	2.1/2 BSP	2" BSP
17-073-4832	3" BSP	2" BSP
17-073-4840	3" BSP	2.1/2 BSP
17-073-6432	4" BSP	2" BSP
17-073-6440	4" BSP	2.1/2 BSP
17-073-6448	4" BSP	3" BSP



#74P
Hex
Locknut

Code	Female
17-074-20	1.1/4 BSP
17-074-24	1.1/2 BSP
17-074-32	2" BSP



#74PF
Flanged
Locknut

Code	Female
17-074F-08	1/2 BSP
17-074F-12	3/4 BSP
17-074F-16	1" BSP
17-074F-20	1.1/4 BSP
17-074F-24	1.1/2 BSP
17-074F-32	2" BSP



#85P
F&F
Barrel Union

Code	Female
17-085-08	1/2 BSP
17-085-12	3/4 BSP
17-085-16	1" BSP
17-085-20	1.1/4 BSP
17-085-24	1.1/2 BSP
17-085-32	2" BSP
17-085-40	2.1/2 BSP
17-085-48	3" BSP



#87P
M&F
Barrel Union

Code	Threads
17-087-08	1/2 BSP
17-087-12	3/4 BSP
17-087-16	1" BSP
17-087-20	1.1/4 BSP
17-087-24	1.1/2 BSP
17-087-32	2" BSP
17-087-40	2.1/2 BSP
17-087-48	3" BSP

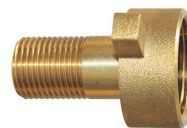

Threaded Nut
and Tail

Code	Female	Male
17-MC1608	1" BSP	1/2 BSP

Most fittings in this category are available chrome plated. Please contact the sales office for further details.

Brass Capillary Fittings. (Category 17)



#46P (T3)
Male
Connector

Code	O.D.	Male
17-046-0604	3/8	1/4 BSP
17-046-0606	3/8	3/8 BSP
17-046-0804	1/2	1/4 BSP
17-046-0806	1/2	3/8 BSP
17-046-0808	1/2	1/2 BSP
17-046-0812	1/2	3/4 BSP
17-046-1208	3/4	1/2 BSP
17-046-1212	3/4	3/4 BSP
17-046-1612	1"	3/4 BSP
17-046-1616	1"	1" BSP
17-046-2016	1.1/4	1" BSP
17-046-2020	1.1/4	1.1/4 BSP
17-046-2420	1.1/2	1.1/4 BSP
17-046-2424	1.1/2	1.1/2 BSP
17-046-3224	2"	1.1/2 BSP
17-046-3232	2"	2" BSP



#49FP (T14)
Female Elbow
Connector

Code	O.D.	Female
17-049F-08	1/2	1/2 BSP
17-049F-12	3/4	3/4 BSP
17-049F-1208	3/4	1/2 BSP
17-049F-16	1"	1" BSP
17-049F-20	1.1/4	1.1/4 BSP
17-049F-24	1.1/2	1.1/2 BSP
17-049F-32	2"	2" BSP



#61P (T61)
Stop
End Cap

Code	O.D.
17-061-08	1/2
17-061-12	3/4
17-061-16	1"



#62P (T62)
Female Nut
Connector

Code	O.D.	Female
17-062-0808	1/2	1/2 BSP
17-062-1212	3/4	3/4 BSP
17-062-1216	3/4	1" BSP
17-062-1620	1"	1.1/4 BSP



#49FLP (T15)
Female
Lugged Elbow

Code	O.D.	Female
17-049FL-08	1/2	1/2 BSP
17-049FL-12	3/4	3/4 BSP



#63P (T63)
Female Nut
Elb Connector

Code	O.D.	Female
17-063-0808	1/2	1/2 BSP
17-063-1212	3/4	3/4 BSP



#46FP (T4)
Female
Connector

Code	O.D.	Female
17-046F-0808	1/2	1/2 BSP
17-046F-1008	5/8	1/2 BSP
17-046F-1012	5/8	3/4 BSP
17-046F-1208	3/4	1/2 BSP
17-046F-1212	3/4	3/4 BSP
17-046F-1616	1"	1" BSP
17-046F-2020	1.1/4	1.1/4 BSP
17-046F-2424	1.1/2	1.1/2 BSP
17-046F-3232	2"	2" BSP



#49MP (T13)
Male Elbow
Connector

Code	O.D.	Male
17-049M-08	1/2	1/2 BSP
17-049M-12	3/4	3/4 BSP
17-049M-16	1"	1" BSP
17-049M-20	1.1/4	1.1/4 BSP
17-049M-24	1.1/2	1.1/2 BSP
17-049M-32	2"	2" BSP



#84P (T11)
Tube
Barrel Union

Code	O.D.
17-084-08	1/2
17-084-12	3/4
17-084-16	1"
17-084-20	1.1/4
17-084-24	1.1/2
17-084-32	2"



#49MLP (19BP)
Male Lugged
Elbow

Code	O.D.	Male
17-049ML-0808	1/2	1/2 BSP
17-049MLE-08	1/2	1/2 BSP
NOTE : Extended Male		
17-049ML-1008	5/8	1/2 BSP
17-049ML-1208	3/4	1/2 BSP



#89P (T4F)
Female
Tube Bush

Code	O.D.	Female
17-089-16	1"	1" BSP
17-089-20	1.1/4	1.1/4 BSP
17-089-24	1.1/2	1.1/2 BSP
17-089-32	2"	2" BSP
17-089-40	2.1/2	2.1/2 BSP
17-089-48	3"	3" BSP
17-089-64	4"	4" BSP



#49P (T12)
Tube
Elbow

Code	O.D.
17-049-08	1/2
17-049-12	3/4
17-049-16	1"
17-049-24	1.1/2
17-049-32	2"



#50P (T24)
Tube
Tee

Code	O.D.
17-050-08	1/2

Brass Capillary Fittings. (Category 17)



#85CP (T69F)
Tube / Female
Barrel Union

Code	O.D.	Female
17-085C-0808	1/2	1/2 BSP
17-085C-1208	3/4	1/2 BSP
17-085C-1212	3/4	3/4 BSP
17-085C-1616	1"	1" BSP
17-085C-2020	1.1/4	1.1/4 BSP
17-085C-2424	1.1/2	1.1/2 BSP
17-085C-3232	2"	2" BSP
17-085C-4040	2.1/2	2.1/2 BSP
17-085C-4848	3"	3" BSP



#87CP (T69)
Tube / Male
Barrel Union

Code	O.D.	Male
17-087C-0808	1/2	1/2 BSP
17-087C-1208	3/4	1/2 BSP
17-087C-1212	3/4	3/4 BSP
17-087C-1612	1"	3/4 BSP
17-087C-1616	1"	1" BSP
17-087C-2020	1.1/4	1.1/4 BSP
17-087C-2424	1.1/2	1.1/2 BSP
17-087C-3232	2"	2" BSP
17-087C-4040	2.1/2	2.1/2 BSP
17-087C-4848	3"	3" BSP



#88P (T4)
Male Tube
Bush

Code	O.D.	Male
17-088-08	1/2	1/2 BSP
17-088-0812	1/2	3/4 BSP
17-088-1008	5/8	1/2 BSP
17-088-12	3/4	3/4 BSP
17-088-1216	3/4	1" BSP
17-088-16	1"	1" BSP
17-088-20	1.1/4	1.1/4 BSP
17-088-24	1.1/2	1.1/2 BSP
17-088-32	2"	2" BSP
17-088-40	2.1/2	2.1/2 BSP
17-088-48	3"	3" BSP
17-088-64	4"	4" BSP

Copper Capillary Fittings. (Category 17)



#33C
Tube
Cap

Code	O.D.
17-033C-08	1/2
17-033C-10	5/8
17-033C-12	3/4
17-033C-16	1"
17-033C-20	1.1/4
17-033C-24	1.1/2
17-033C-32	2"
17-033C-40	2.1/2
17-033C-48	3"
17-033C-64	4"



#49C
90° Tube
Coupling

Code	O.D.	O.D.
17-049C-06	3/8	3/8
17-049C-08	1/2	1/2
17-049C-10	5/8	5/8
17-049C-12	3/4	3/4
17-049C-1208	3/4	1/2
17-049C-16	1"	1"
17-049C-1612	1"	3/4
17-049C-20	1.1/4	1.1/4
17-049C-24	1.1/2	1.1/2
17-049C-32	2"	2"
17-049C-40	2.1/2	2.1/2
17-049C-48	3"	3"
17-049C-64	4"	4"
17-049C-96	6"	6"



#50C
Tube
Tee

Code	O.D.	O.D.	O.D.
17-050C-06	3/8	3/8	3/8
17-050C-08	1/2	1/2	1/2
17-050C-10	5/8	5/8	5/8
17-050C-12	3/4	3/4	3/4
17-050C-16	1"	1"	1"
17-050C-20	1.1/4	1.1/4	1.1/4
17-050C-24	1.1/2	1.1/2	1.1/2
17-050C-32	2"	2"	2"
17-050C-48	3"	3"	3"



#47C
Tube
Coupling

Code	O.D.	O.D.
17-047C-06	3/8	3/8
17-047C-08	1/2	1/2
17-047C-10	5/8	5/8
17-047C-12	3/4	3/4
17-047C-1208	3/4	1/2
17-047C-16	1"	1"
17-047C-20	1.1/4	1.1/4
17-047C-24	1.1/2	1.1/2
17-047C-32	2"	2"
17-047C-3216	2"	1"
17-047C-40	2.1/2	2.1/2
17-047C-48	3"	3"
17-047C-64	4"	4"
17-047C-96	6"	6"



#49C
45° Tube
Coupling

Code	O.D.	O.D.
17-049CD-08	1/2	1/2
17-049CD-10	5/8	5/8
17-049CD-12	3/4	3/4
17-049CD-16	1"	1"
17-049CD-20	1.1/4	1.1/4
17-049CD-24	1.1/2	1.1/2
17-049CD-32	2"	2"
17-049CD-40	2.1/2	2.1/2
17-049CD-48	3"	3"
17-049CD-64	4"	4"

Copper Press Fittings also available to order for sizes up to 2" (50mm)

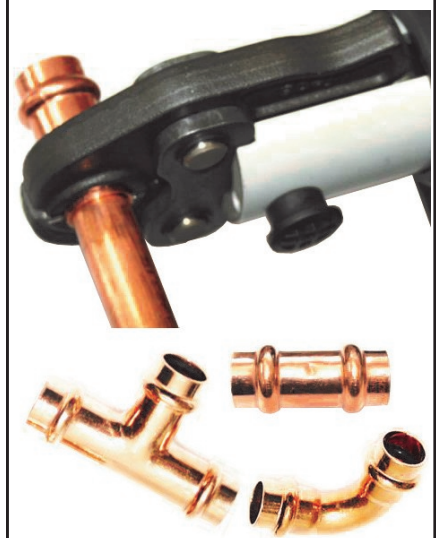

Brass 60° BSP Flare Fittings. (Category 17)



BSP Flare Nut

Code	Tube
17-006-04	1/4
17-006-05	5/16
17-006-06	3/8
17-006-08	1/2
17-006-12	3/4
17-006-16	1"
17-006-20	1.1/4
17-006-24	1.1/2
17-006-32	2"



BSP Flare x BSP Male Straight

Code	Tube	Male
17-007-0404	1/4	1/4 BSP
17-007-0604	3/8	1/4 BSP
17-007-0606	3/8	3/8 BSP
17-007-0608	3/8	1/2 BSP
17-007-0804	1/2	1/4 BSP
17-007-0806	1/2	3/8 BSP
17-007-0808	1/2	1/2 BSP
17-007-0812	1/2	3/4 BSP
17-007-1208	3/4	1/2 BSP
17-007-1212	3/4	3/4 BSP
17-007-1216	3/4	1" BSP
17-007-1612	1"	3/4 BSP
17-007-1616	1"	1" BSP
17-007-1620	1"	1.1/4 BSP
17-007-2020	1.1/4	1.1/4 BSP
17-007-2424	1.1/2	1.1/2 BSP
17-007-3232	2"	2" BSP



BSP Flare x BSP Male Elbow

Code	Tube	Male
17-008-0606	3/8	3/8 BSP
17-008-0806	1/2	3/8 BSP
17-008-0808	1/2	1/2 BSP
17-008-0812	1/2	3/4 BSP
17-008-1212	3/4	3/4 BSP
17-008-1216	3/4	1" BSP
17-008-1616	1"	1" BSP



BSP Flare x BSP Male Lugged Elbow

Code	Tube	Male
17-008L-0808	1/2	1/2 BSP



BSP Flare x BSP Female Straight

Code	Tube	Female
17-016-0604	3/8	1/4 BSP
17-016-0808	1/2	1/2 BSP
17-016-0812	1/2	3/4 BSP
17-016-1208	3/4	1/2 BSP
17-016-1212	3/4	3/4 BSP
17-016-1612	1"	3/4 BSP
17-016-1616	1"	1" BSP



BSP Flare x BSP Flare Elbow

Code	Tube	Tube
17-018-06	3/8	3/8
17-018-08	1/2	1/2
17-018R-1208	3/4	1/2
17-018-12	3/4	3/4



BSP Flare x BSP Flare Tee

Code	Tube	Tube	Tube
17-019-06	3/8	3/8	3/8
17-019-08	1/2	1/2	1/2
17-019-12	3/4	3/4	3/4



BSP Flare x BSP Female Tee

Code	Tube	Tube	Female
17-020F-0808	1/2	1/2	1/2 BSP
17-020F-1208	3/4	3/4	1/2 BSP
17-020F-1212	3/4	3/4	3/4 BSP



BSP Flare x BSP Female Lugged Tee

Code	Tube	Tube	Female
17-020FL-0808	1/2	1/2	1/2 BSP



BSP Flare x BSP Female Elbow

Code	Tube	Female
17-036-0606	3/8	3/8 BSP
17-036-0608	3/8	1/2 BSP
17-036-0808	1/2	1/2 BSP
17-036-0812	1/2	3/4 BSP
17-036-1208	3/4	1/2 BSP
17-036-1212	3/4	3/4 BSP
17-036-1616	1"	1" BSP
17-036-2020	1.1/4	1.1/4 BSP
17-036-2424	1.1/2	1.1/2 BSP
17-036-3232	2"	2" BSP



BSP Flare x BSP Female Lugged Elbow

Code	Tube	Female
17-036L-0808	1/2	1/2 BSP
17-036L-1208	3/4	1/2 BSP
17-036L-1212	3/4	3/4 BSP



BSP Flare Cap

Code	Tube
17-056-08	1/2
17-056-12	3/4



BSP Flare x BSP Copper Straight

Code	Tube	Tube
17-086-08	1/2	1/2
17-086R-1208	3/4	1/2
17-086-12	3/4	3/4
17-086-16	1"	1"

Nylon Olive Compression Plumbing Fittings. (Category 17)



Nylon Compression Olive

Code	Tube
17-001N-06	3/8
17-001N-08	1/2
17-001N-12	3/4
17-001N-16	1"



Kinco Compression Nut

Code	Tube
17-002-06	3/8
17-002-08	1/2
17-002-12	3/4
17-002-16	1"



Nylon Comp x BSP Male Straight

Code	Tube	Male
17-003N-0808	1/2	1/2 BSP
17-003N-0812	1/2	3/4 BSP
17-003N-1208	3/4	1/2 BSP
17-003N-1212	3/4	3/4 BSP
17-003N-1616	1"	1" BSP



Nylon Comp Union Straight

Code	Tube	Tube
17-004N-08	1/2	1/2
17-004RN-0806	1/2	3/8
17-004N-12	3/4	3/4
17-004RN-1208	3/4	1/2
17-004N-16	1"	1"



Nylon Comp x BSP Male Elbow

Code	Tube	Male
17-005N-0808	1/2	1/2 BSP
17-005N-0812	1/2	3/4 BSP
17-005N-1208	3/4	1/2 BSP
17-005N-1212	3/4	3/4 BSP



Nylon Comp x BSP Male Lugged Elbow

Code	Tube	Male
17-005LN-0808	1/2	1/2 BSP



Nylon Comp x BSP Female Straight

Code	Tube	Female
17-010N-0808	1/2	1/2 BSP
17-010N-0812	1/2	3/4 BSP
17-010N-1208	3/4	1/2 BSP
17-010N-1212	3/4	3/4 BSP
17-010N-1616	1"	1" BSP



Nylon Comp Union Elbow

Code	Tube	Tube
17-011N-08	1/2	1/2
17-011N-12	3/4	3/4
17-011RN-1208	3/4	1/2
17-011N-16	1"	1"



Nylon Comp x BSP Female Branch Tee

Code	Tube	Female
17-012FN-0808	1/2	1/2 BSP
17-012FN-1208	3/4	1/2 BSP



Nylon Comp x BSP Female Lugged Tee

Code	Tube	Female
17-012FLN-0808	1/2	1/2 BSP



Nylon Comp Union Tee

Code	Tube	Tube	Tube
17-014N-08	1/2	1/2	1/2
17-014N-12	3/4	3/4	3/4
17-014RN-1208	3/4	3/4	1/2



Nylon Comp x BSP Female Elbow

Code	Tube	Female
17-015N-0808	1/2	1/2 BSP
17-015N-0812	1/2	3/4 BSP
17-015N-1208	3/4	1/2 BSP
17-015N-1212	3/4	3/4 BSP
17-015N-1616	1"	1" BSP



Nylon Comp x BSP Female Lugged Elbow

Code	Tube	Female
17-015LN-0808	1/2	1/2 BSP
17-015LN-1208	3/4	1/2 BSP
17-015LN-1212	3/4	3/4 BSP



Nylon Compression Stop End

Code	Tube
17-065N-08	1/2
17-065N-12	3/4

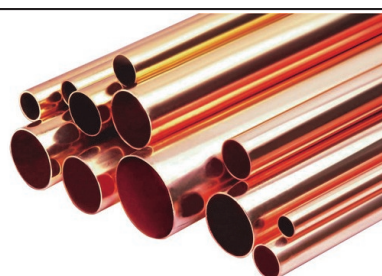
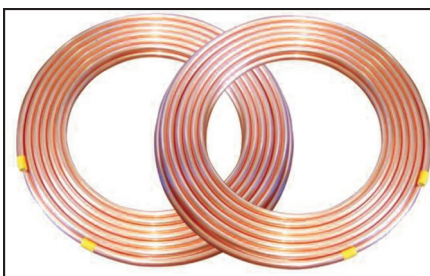

Copper Tube also available in annealed coils and hard drawn lengths.

Refer Category 45

Copper Olive Compression Plumbing Fittings. (Category 17)



Copper Compression Olive

Code	Tube
17-001-08	1/2
17-001-12	3/4
17-001-16	1"
17-001-20	1.1/4
17-001-24	1.1/2
17-001-32	2"



Copper Comp Union Straight

Code	Tube	Tube
17-004-08	1/2	1/2
17-004-12	3/4	3/4
17-004R-1208	3/4	1/2
17-004-16	1"	1"
17-004R-1612	1"	3/4
17-004-20	1.1/4	1.1/4
17-004-24	1.1/2	1.1/2
17-004-32	2"	2"



Copper Comp x BSP Female Branch Tee

Code	Tube	Female
17-012F-0808	1/2	1/2 BSP
17-012F-1208	3/4	1/2 BSP
17-012F-1212	3/4	3/4 BSP



Kinco Compression Nut

Code	Tube
17-002-08	1/2
17-002-12	3/4
17-002-16	1"
17-002-20	1.1/4
17-002-24	1.1/2
17-002-32	2"



Copper Comp x BSP Male Elbow

Code	Tube	Male
17-005-0808	1/2	1/2 BSP
17-005-0812	1/2	3/4 BSP
17-005-1208	3/4	1/2 BSP
17-005-1212	3/4	3/4 BSP



Copper Comp Union Tee

Code	Tube	Tube	Tube
17-014-08	1/2	1/2	1/2
17-014-12	3/4	3/4	3/4
17-014R-1208	3/4	3/4	1/2
17-014-16	1"	1"	1"



Copper Comp x BSP Male Straight

Code	Tube	Male
17-003-0808	1/2	1/2 BSP
17-003-0812	1/2	3/4 BSP
17-003-1208	3/4	1/2 BSP
17-003-1212	3/4	3/4 BSP
17-003-1612	1"	3/4 BSP
17-003-1616	1"	1" BSP
17-003-2020	1.1/4	1.1/4 BSP
17-003-2424	1.1/2	1.1/2 BSP
17-003-3232	2"	2" BSP



Copper Comp x BSP Female Straight

Code	Tube	Female
17-010-0808	1/2	1/2 BSP
17-010-0812	1/2	3/4 BSP
17-010-1208	3/4	1/2 BSP
17-010-1212	3/4	3/4 BSP
17-010-1616	1"	1" BSP



Copper Comp x BSP Female Elbow

Code	Tube	Female
17-015-0808	1/2	1/2 BSP
17-015-0812	1/2	3/4 BSP
17-015-1208	3/4	1/2 BSP
17-015-1212	3/4	3/4 BSP

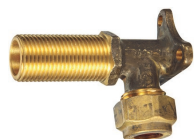

Copper Comp x BSP Male Lugged Elbow

Code	Tube	Male
17-005L-0808	1/2	1/2 BSP



Copper Comp Union Elbow

Code	Tube	Tube
17-011-08	1/2	1/2
17-011-12	3/4	3/4
17-011R-1208	3/4	1/2



Copper Comp x BSP Female Lugged Elbow

Code	Tube	Female
17-015L-0808	1/2	1/2 BSP



Copper Compression Stop End

Code	Tube
17-065-08	1/2
17-065-12	3/4



We also have a large range of Imperial Flaring, Bending and Cutting Tools. Refer Category 65



OXY / ACETYLENE FITTINGS (Category 18)

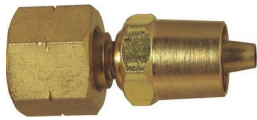

Re-Usable
Female Hose
Ends

Code	Hose	Female
18-112	5mm	5/8 UNF RH (Oxy)
18-240	5mm	5/8 UNF LH (Acet)



Male / Male
Unions
UNF/UNF

Code	Male
18-34	5/8 UNF RH (Oxy)
18-35	5/8 UNF LH (Acet)



Nut &
Tail Hose
Ends

Code	Hose	Female
18-651	5mm	5/8 UNF RH (Oxy)
18-652	5mm	5/8 UNF LH (Acet)
18-681	8mm	5/8 UNF RH (Oxy)
18-682	8mm	5/8 UNF LH (Acet)
18-691	10mm	5/8 UNF RH (Oxy)
18-692	10mm	5/8 UNF LH (Acet)

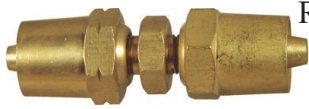

Re-Usable
Hose
Joiner

Code	Hose
18-265	5mm



Female / Male
Unions
UNF/BSP

Code	Female	Male
18-29	5/8 UNF RH (Oxy)	1/4 BSPT
18-92	5/8 UNF LH (Acet)	1/4 BSPT



Male / Male
Unions
UNF/BSP

Code	Male	Male
18-27	5/8 UNF RH (Oxy)	1/4 BSPT
18-90	5/8 UNF LH (Acet)	1/4 BSPT
18-90N	5/8 UNF LH (Acet)	1/4 NPT



Male / Male
Y Unions
UNF/UNF

Code	Male
18-121	5/8 UNF RH (Oxy)
18-215	5/8 UNF LH (Acet)



Quick Couplers for Oxy / Acetylene also Available. Refer Category 8

LPG FITTINGS (Category 18)

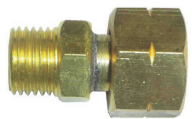

3/8 LH Female
Companion x
1/4 BSP Male

Code : 18-AC03



3/8 LH Female
Companion x
POL 9kg Female

Code : 18-AC10



9kg POL Male
x M14 Primus
Female Elbow

Code : 18-AC23



3/8 LH Female
Companion x 1/4
BSP Male Elbow

Code : 18-AC03A

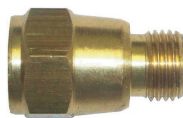

M14 Primus
Female x 1/4
BSP Male

Code : 18-AC17A



9kg POL Male x
3/8 LH Male
Companion Elbow

Code : 18-AC24

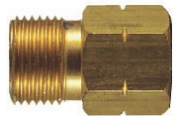

3/8 LH Male
Companion x 1/4
BSP Female

Code : 18-AC04



9kg POL
Male x 1/4
BSP Male

Code : 18-AC18



Coned Male
Branch Tee
Piece

Code	Male	Male	Male
18-AC25	1/4 BSP	1/4 BSP	1/4 BSP
18-AC25A	1/4 BSP	1/4 BSP	3/8 BSP



3/8 LH Male
Companion x 1/4
BSP Male

Code : 18-AC04A



9kg POL Male
x M14 Primus
Female

Code : 18-AC19



3/8 LH Female
Companion x
M14 Primus Fem

Code : 18-AC09



9kg POL Male
x 3/8 LH Male
Companion

Code : 18-AC19



3/8 LH Female
x POL 9kg
Female Elbow

Code : 18-AC59

Push-In Fittings. Imperial Tube sizes (Category 20)



QF3
Male
Connector

Code	Tube	Male
20-003-0202	1/8	1/8 BSPT
20-003-0204	1/8	1/4 BSPT
20-003-02M05	1/8	M5x0.8
20-003-0302	3/16	1/8 BSPT
20-003-0304	3/16	1/4 BSPT
20-003-03M05	3/16	M5x0.8
20-003-0402	1/4	1/8 BSPT
20-003-0404	1/4	1/4 BSPT
20-003-0406	1/4	3/8 BSPT
20-003-04M05	1/4	M5x0.8
20-003-05N02	5/16	1/8 NPT
20-003-0602	3/8	1/8 BSPT
20-003-0604	3/8	1/4 BSPT
20-003-0606	3/8	3/8 BSPT
20-003-0608	3/8	1/2 BSPT
20-003-0804	1/2	1/4 BSPT
20-003-0806	1/2	3/8 BSPT
20-003-0808	1/2	1/2 BSPT



QF4
Tube
Union

Code	Tube
20-004-02	1/8
20-004-03	3/16
20-004-04	1/4
20-004-06	3/8
20-004-08	1/2



QF4R
Reducing Tube
Union

Code	Tube	Tube
20-004R-0504	5/16	1/4
20-004R-0605	3/8	5/16
20-004R-0806	1/2	3/8



QF7
Single Banjo
M&F Elbow

Code	Tube	Male	Female
20-007-0402	1/4	1/8 BSPT	1/8 BSP
20-007-0404	1/4	1/4 BSPT	1/4 BSP
20-007-0604	3/8	1/4 BSPT	1/4 BSP
20-007-0606	3/8	3/8 BSPT	3/8 BSP



QF5
Male Elbow
Connector

Code	Tube	Male
20-005-0202	1/8	1/8 BSPT
20-005-0204	1/8	1/4 BSPT
20-005-02M05	1/8	M5x0.8
20-005-0302	3/16	1/8 BSPT
20-005-0304	3/16	1/4 BSPT
20-005-0402	1/4	1/8 BSPT
20-005-0404	1/4	1/4 BSPT
20-005-0406	1/4	3/8 BSPT
20-005-04M05	1/4	M5x0.8
20-005-04N06	1/4	3/8 NPT
20-005-05N02	5/16	1/8 NPT
20-005-05N04	5/16	1/4 NPT
20-005-05N06	5/16	3/8 NPT
20-005-0602	3/8	1/8 BSPT
20-005-0604	3/8	1/4 BSPT
20-005-0606	3/8	3/8 BSPT
20-005-0608	3/8	1/2 BSPT
20-005-06N08	3/8	1/2 NPT
20-005-0804	1/2	1/4 BSPT
20-005-0806	1/2	3/8 BSPT
20-005-0808	1/2	1/2 BSPT



QF5A
Stem
Elbow

Code	Stem	Tube
20-005A-02	1/8	1/8
20-005A-03	3/16	3/16
20-005A-04	1/4	1/4
20-005AR-0403	1/4	3/16
20-005AR-0503	5/16	3/16
20-005AR-0504	5/16	1/4
20-005A-06	3/8	3/8
20-005AR-0604	3/8	1/4
20-005AR-0605	3/8	5/16
20-005A-08	1/2	1/2
20-005AR-0805	1/2	5/16
20-005AR-0806	1/2	3/8

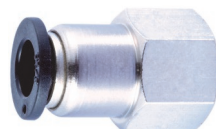

QF10
Female
Connector

Code	Tube	Male
20-010-0402	1/4	1/8 BSP
20-010-0404	1/4	1/4 BSP
20-010-0412	1/4	3/4 BSP
20-010-0604	3/8	1/4 BSP
20-010-0606	3/8	3/8 BSP



QF5L
Long Male
Elbow Connector

Code	Tube	Male
20-005L-0202	1/8	1/8 BSPT
20-005L-0204	1/8	1/4 BSPT
20-005L-02M05	1/8	M5x0.8
20-005L-0302	3/16	1/8 BSPT
20-005L-0304	3/16	1/4 BSPT
20-005L-0402	1/4	1/8 BSPT
20-005L-0404	1/4	1/4 BSPT
20-005L-0406	1/4	3/8 BSPT
20-005L-0604	3/8	1/4 BSPT
20-005L-0606	3/8	3/8 BSPT
20-005L-0608	3/8	1/2 BSPT
20-005L-0804	1/2	1/4 BSPT
20-005L-0806	1/2	3/8 BSPT
20-005L-0808	1/2	1/2 BSPT

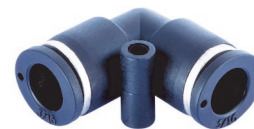

QF11
Union
Elbow

Code	Tube
20-011-02	1/8
20-011-03	3/16
20-011-04	1/4
20-011-06	3/8
20-011-08	1/2



QF12
Male Branch
Tee

Code	Tube	Male
20-012-0202	1/8	1/8 BSPT
20-012-0204	1/8	1/4 BSPT
20-012-02M05	1/8	M5x0.8
20-012-0302	3/16	1/8 BSPT
20-012-0304	3/16	1/4 BSPT
20-012-0402	1/4	1/8 BSPT
20-012-0404	1/4	1/4 BSPT
20-012-0406	1/4	3/8 BSPT
20-012-0408	1/4	1/2 BSPT
20-012-05N02	5/16	1/8 NPT
20-012-0602	3/8	1/8 BSPT
20-012-0604	3/8	1/4 BSPT
20-012-0606	3/8	3/8 BSPT
20-012-0608	3/8	1/2 BSPT
20-012-0804	1/2	1/4 BSPT
20-012-0806	1/2	3/8 BSPT
20-012-0808	1/2	1/2 BSPT

Push-In Fittings. Imperial Tube sizes (Category 20)



QF13
Male Run
Tee

Code	Tube	Male
20-013-0202	1/8	1/8 BSPT
20-013-0204	1/8	1/4 BSPT
20-013-02M05	1/8	M5x0.8
20-013-0302	3/16	1/8 BSPT
20-013-0304	3/16	1/4 BSPT
20-013-0402	1/4	1/8 BSPT
20-013-0404	1/4	1/4 BSPT
20-013-0406	1/4	3/8 BSPT
20-013-0604	3/8	1/4 BSPT
20-013-0606	3/8	3/8 BSPT
20-013-0608	3/8	1/2 BSPT
20-013-0804	1/2	1/4 BSPT
20-013-0806	1/2	3/8 BSPT
20-013-0808	1/2	1/2 BSPT



QF14
Union
Tee

Code	Tube
20-014-02	1/8
20-014-03	3/16
20-014-04	1/4
20-014-06	3/8
20-014-08	1/2



QF14R
Reducing
Union Tee

Code	Tube	Tube
20-014R-02M04	1/8	4mm

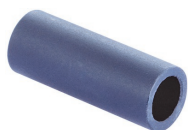

QF27
Push-In
Nipple

Code	Tube
20-027-03	3/16
20-027-04	1/4
20-027-06	3/8
20-027-08	1/2



QF68
Union
Cross

Code	Tube
20-068-04	1/4



QF31
Bulkhead
Tube Union

Code	Tube
20-031-02	1/8
20-031-03	3/16
20-031-04	1/4
20-031-06	3/8
20-031-08	1/2

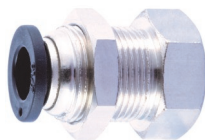

QF31F
Female
Bulkhead

Code	Tube	Female
20-031F-0204	1/8	1/4 BSP
20-031F-0302	3/16	1/8 BSP
20-031F-0402	1/4	1/8 BSP
20-031F-0404	1/4	1/4 BSP
20-031F-0604	3/8	1/4 BSP
20-031F-0606	3/8	3/8 BSP
20-031F-0806	1/2	3/8 BSP
20-031F-0808	1/2	1/2 BSP



QF33
Tube
Cap

Code	Tube
20-033-03	3/16
20-033-04	1/4
20-033-06	3/8
20-033-08	1/2



QF64
Tube
Plug

Code	Tube
20-064-02	1/8
20-064-03	3/16
20-064-04	1/4
20-064-06	3/8
20-064-08	1/2



QF73
Push-In
Reducing Nipple

Code	Tube	Tube
20-073-0403	1/4	3/16
20-073-0504	5/16	1/4
20-073-0605	3/8	5/16
20-073-0806	1/2	3/8



QF72A
Stem
Reducer

Code	Stem	Tube
20-072A-0403	1/4	3/16
20-072A-0503	5/16	3/16
20-072A-0504	5/16	1/4
20-072A-0604	3/8	1/4
20-072A-0605	3/8	5/16
20-072A-0804	1/2	1/4
20-072A-0805	1/2	5/16
20-072A-0806	1/2	3/8



QF75
Union
Y

Code	Tube
20-075-02	1/8
20-075-03	3/16
20-075-04	1/4
20-075-06	3/8
20-075-08	1/2



QF75A
Stem Y
Connector

Code	Tube
20-075A-02	1/8
20-075A-03	3/16
20-075A-04	1/4



QF76
Male Branch
Y

Code	Tube	Male
20-076-0202	1/8	1/8 BSPT
20-076-0204	1/8	1/4 BSPT
20-076-02M05	1/8	M5x0.8
20-076-0302	3/16	1/8 BSPT
20-076-0304	3/16	1/4 BSPT
20-076-0402	1/4	1/8 BSPT
20-076-0404	1/4	1/4 BSPT
20-076-0406	1/4	3/8 BSPT
20-076-0604	3/8	1/4 BSPT
20-076-0606	3/8	3/8 BSPT
20-076-0608	3/8	1/2 BSPT
20-076-0804	1/2	1/4 BSPT
20-076-0806	1/2	3/8 BSPT
20-076-0808	1/2	1/2 BSPT

Push-In Fittings. Metric Tube sizes (Category 20)



**QFM3
Male
Connector**

Code	Tube	Male
20-M003-0402	4mm	1/8 BSPT
20-M003-0404	4mm	1/4 BSPT
20-M003-04M03	4mm	M3x0.5
20-M003-04M05	4mm	M5x0.8
20-M003-04M06	4mm	M6x1.0
20-M003-04M07	4mm	M7x1.0
20-M003-0602	6mm	1/8 BSPT
20-M003-0604	6mm	1/4 BSPT
20-M003-0606	6mm	3/8 BSPT
20-M003-0608	6mm	1/2 BSPT
20-M003-06M05	6mm	M5x0.8
20-M003-06M07	6mm	M7x1.0
20-M003-06P02	6mm	1/8 BSPP
20-M003-06P04	6mm	1/4 BSPP
20-M003-0802	8mm	1/8 BSPT
20-M003-0804	8mm	1/4 BSPT
20-M003-0806	8mm	3/8 BSPT
20-M003-0808	8mm	1/2 BSPT
20-M003-08P02	8mm	1/8 BSPP
20-M003-08P04	8mm	1/4 BSPP
20-M003-1002	10mm	1/8 BSPT
20-M003-1004	10mm	1/4 BSPT
20-M003-1006	10mm	3/8 BSPT
20-M003-1008	10mm	1/2 BSPT
20-M003-10P04	10mm	1/4 BSPP
20-M003-1204	12mm	1/4 BSPT
20-M003-1206	12mm	3/8 BSPT
20-M003-1208	12mm	1/2 BSPT
20-M003-1406	14mm	3/8 BSPT
20-M003-1408	14mm	1/2 BSPT
20-M003-1606	16mm	3/8 BSPT
20-M003-1608	16mm	1/2 BSPT



**QFM4
Tube
Union**

Code	Tube
20-M004-04	4mm
20-M004-06	6mm
20-M004-08	8mm
20-M004-10	10mm
20-M004-12	12mm
20-M004-14	14mm
20-M004-16	16mm



**QFM3SH
In-Hex Male
Connector**

Code	Tube	Male
20-M003SH-0402	4mm	1/8 BSPT
20-M003SH-0404	4mm	1/4 BSPT
20-M003SH-04M05	4mm	M5x0.8
20-M003SH-0602	6mm	1/8 BSPT
20-M003SH-0604	6mm	1/4 BSPT
20-M003SH-0606	6mm	3/8 BSPT
20-M003SH-06M05	6mm	M5x0.8
20-M003SH-0802	8mm	1/8 BSPT
20-M003SH-0804	8mm	1/4 BSPT
20-M003SH-0806	8mm	3/8 BSPT
20-M003SH-0808	8mm	1/2 BSPT
20-M003SH-1002	10mm	1/8 BSPT
20-M003SH-1004	10mm	1/4 BSPT
20-M003SH-1006	10mm	3/8 BSPT
20-M003SH-1008	10mm	1/2 BSPT
20-M003SH-1204	12mm	1/4 BSPT
20-M003SH-1206	12mm	3/8 BSPT
20-M003SH-1208	12mm	1/2 BSPT



**QFM4R
Reducing
Tube Union**

Code	Tube	Tube
20-M004R-04I02	4mm	1/8
20-M004R-0604	6mm	4mm
20-M004R-0804	8mm	4mm
20-M004R-0806	8mm	6mm
20-M004R-1006	10mm	6mm
20-M004R-1008	10mm	8mm
20-M004R-1210	12mm	10mm
20-M004R-1612	16mm	12mm



**QFM6D
Double Banjo
Male Elbow**

Code	Tube	Male
20-M006D-0602	6mm	1/8 BSPT



**QFM6T
Triple Banjo
Male Elbow**

Code	Tube	Male
20-M006T-0602	6mm	1/8 BSPT
20-M006T-0604	6mm	1/4 BSPT
20-M006T-1006	10mm	3/8 BSPT



**QFM5
Male Elbow
Connector**

Code	Tube	Male
20-M005-03M05	3mm	M5x0.8
20-M005-0402	4mm	1/8 BSPT
20-M005-0404	4mm	1/4 BSPT
20-M005-0406	4mm	3/8 BSPT
20-M005-04M03	4mm	M3x0.5
20-M005-04M05	4mm	M5x0.8
20-M005-04P02	4mm	1/8 BSPP
20-M005-04P04	4mm	1/4 BSPP
20-M005-0602	6mm	1/8 BSPT
20-M005-0604	6mm	1/4 BSPT
20-M005-0606	6mm	3/8 BSPT
20-M005-0608	6mm	1/2 BSPT
20-M005-06M05	6mm	M5x0.8
20-M005-06M07	6mm	M7x1.0
20-M005-06M12	6mm	M12x1.5
20-M005-06P02	6mm	1/8 BSPP
20-M005-06P04	6mm	1/4 BSPP
20-M005-0802	8mm	1/8 BSPT
20-M005-0804	8mm	1/4 BSPT
20-M005-0806	8mm	3/8 BSPT
20-M005-0808	8mm	1/2 BSPT
20-M005-08P02	8mm	1/8 BSPP
20-M005-08P04	8mm	1/4 BSPP
20-M005-1002	10mm	1/8 BSPT
20-M005-1004	10mm	1/4 BSPT
20-M005-1006	10mm	3/8 BSPT
20-M005-1008	10mm	1/2 BSPT
20-M005-1202	12mm	1/8 BSPT
20-M005-1204	12mm	1/4 BSPT
20-M005-1206	12mm	3/8 BSPT
20-M005-1208	12mm	1/2 BSPT
20-M005-12N04	12mm	1/4 NPT
20-M005-1406	14mm	3/8 BSPT
20-M005-1408	14mm	1/2 BSPT
20-M005-1606	16mm	3/8 BSPT
20-M005-1608	16mm	1/2 BSPT



**QFM11
Union
Elbow**

Code	Tube
20-M011-04	4mm
20-M011-06	6mm
20-M011-08	8mm
20-M011-10	10mm
20-M011-12	12mm
20-M011-14	14mm
20-M011-16	16mm

Push-In Fittings. Metric Tube sizes (Category 20)

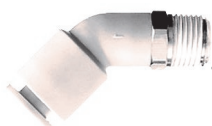

QFM5B
45° Male Elbow
Connector

Code	Tube	Male
20-M005B-0402	4mm	1/8 BSPT
20-M005B-04M05	4mm	M5x0.8
20-M005B-0602	6mm	1/8 BSPT
20-M005B-0604	6mm	1/4 BSPT
20-M005B-0606	6mm	3/8 BSPT
20-M005B-06M05	6mm	M5x0.8
20-M005B-0802	8mm	1/8 BSPT
20-M005B-0804	8mm	1/4 BSPT
20-M005B-0806	8mm	3/8 BSPT
20-M005B-1002	10mm	1/8 BSPT
20-M005B-1004	10mm	1/4 BSPT
20-M005B-1006	10mm	3/8 BSPT
20-M005B-1008	10mm	1/2 BSPT
20-M005B-1204	12mm	1/4 BSPT
20-M005B-1206	12mm	3/8 BSPT
20-M005B-1208	12mm	1/2 BSPT



QFM5A
Stem
Elbow

Code	Stem	Tube
20-M005A-04	4mm	4mm
20-M005AR-0406	4mm	6mm
20-M005A-06	6mm	6mm
20-M005AR-0604	6mm	4mm
20-M005A-08	8mm	8mm
20-M005AR-0804	8mm	4mm
20-M005AR-0806	8mm	6mm
20-M005A-10	10mm	10mm
20-M005AR-1008	10mm	8mm
20-M005A-12	12mm	12mm
20-M005AR-1208	12mm	8mm
20-M005AR-1210	12mm	10mm

Note : Some sizes may still have a metallic stem

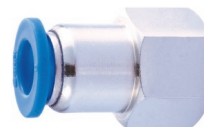

QFM10
Female
Connector

Code	Tube	Female
20-M010-0402	4mm	1/8 BSP
20-M010-0404	4mm	1/4 BSP
20-M010-04M05	4mm	M5x0.8
20-M010-0602	6mm	1/8 BSP
20-M010-0604	6mm	1/4 BSP
20-M010-0606	6mm	3/8 BSP
20-M010-0802	8mm	1/8 BSP
20-M010-0804	8mm	1/4 BSP
20-M010-0806	8mm	3/8 BSP
20-M010-0808	8mm	1/2 BSP
20-M010-1002	10mm	1/8 BSP
20-M010-1004	10mm	1/4 BSP
20-M010-1006	10mm	3/8 BSP
20-M010-1008	10mm	1/2 BSP
20-M010-1204	12mm	1/4 BSP
20-M010-1206	12mm	3/8 BSP
20-M010-1208	12mm	1/2 BSP
20-M010-1608	16mm	1/2 BSP



QFM5L
Long Male
Elbow Connector

Code	Tube	Male
20-M005L-0402	4mm	1/8 BSPT
20-M005L-0404	4mm	1/4 BSPT
20-M005L-04M05	4mm	M5x0.8
20-M005L-0602	6mm	1/8 BSPT
20-M005L-0604	6mm	1/4 BSPT
20-M005L-0606	6mm	3/8 BSPT
20-M005L-06M05	6mm	M5x0.8
20-M005L-0802	8mm	1/8 BSPT
20-M005L-0804	8mm	1/4 BSPT
20-M005L-0806	8mm	3/8 BSPT
20-M005L-1002	10mm	1/8 BSPT
20-M005L-1004	10mm	1/4 BSPT
20-M005L-1006	10mm	3/8 BSPT
20-M005L-1008	10mm	1/2 BSPT
20-M005L-1204	12mm	1/4 BSPT
20-M005L-1206	12mm	3/8 BSPT
20-M005L-1208	12mm	1/2 BSPT



QFM6
Single Banjo
Male Elbow

Code	Tube	Male
20-M006-0402	4mm	1/8 BSPT
20-M006-04M05	4mm	M5x0.8
20-M006-0602	6mm	1/8 BSPT
20-M006-0604	6mm	1/4 BSPT
20-M006-06M05	6mm	M5x0.8
20-M006-0802	8mm	1/8 BSPT
20-M006-0804	8mm	1/4 BSPT
20-M006-0806	8mm	3/8 BSPT
20-M006-1004	10mm	1/4 BSPT
20-M006-1006	10mm	3/8 BSPT
20-M006-1008	10mm	1/2 BSPT
20-M006-1204	12mm	1/4 BSPT
20-M006-1206	12mm	3/8 BSPT
20-M006-1208	12mm	1/2 BSPT



QFM12
Male Branch
Tee

Code	Tube	Male
20-M012-0402	4mm	1/8 BSPT
20-M012-0404	4mm	1/4 BSPT
20-M012-04M05	4mm	M5x0.8
20-M012-0602	6mm	1/8 BSPT
20-M012-0604	6mm	1/4 BSPT
20-M012-0606	6mm	3/8 BSPT
20-M012-06M05	6mm	M5x0.8
20-M012-0802	8mm	1/8 BSPT
20-M012-0804	8mm	1/4 BSPT
20-M012-0806	8mm	3/8 BSPT
20-M012-0808	8mm	1/2 BSPT
20-M012-1002	10mm	1/8 BSPT
20-M012-1004	10mm	1/4 BSPT
20-M012-1006	10mm	3/8 BSPT
20-M012-1008	10mm	1/2 BSPT
20-M012-1204	12mm	1/4 BSPT
20-M012-1206	12mm	3/8 BSPT
20-M012-1208	12mm	1/2 BSPT
20-M012-1408	14mm	1/2 BSPT
20-M012-1606	16mm	3/8 BSPT
20-M012-1608	16mm	1/2 BSPT

Note : BSPP parallel threads are available in some sizes.



QFM11BH
Bulkhead
Union Elbow

Code	Tube
20-M011BH-04	4mm
20-M011BH-06	6mm
20-M011BH-08	8mm
20-M011BH-10	10mm
20-M011BH-12	12mm



QFM7
Single Banjo
M&F Elbow

Code	Tube	Threads
20-M007-0402	4mm	1/8 BSP
20-M007-0602	6mm	1/8 BSP
20-M007-0604	6mm	1/4 BSP
20-M007-0802	8mm	1/8 BSP
20-M007-0804	8mm	1/4 BSP
20-M007-0806	8mm	3/8 BSP
20-M007-1004	10mm	1/4 BSP
20-M007-1006	10mm	3/8 BSP
20-M007-1206	12mm	3/8 BSP
20-M007-1208	12mm	1/2 BSP

Push-In Fittings. Metric Tube sizes (Category 20)



QFM12A
Branch
Stem Tee

Code	Stem	Tube
20-M012A-04	4mm	4mm
20-M012A-06	6mm	6mm
20-M012A-08	8mm	8mm
20-M012A-10	10mm	10mm
20-M012A-12	12mm	12mm



QFM13A
Run
Stem Tee

Code	Stem	Tube
20-M013A-04	4mm	4mm
20-M013A-06	6mm	6mm
20-M013A-08	8mm	8mm
20-M013A-10	10mm	10mm
20-M013A-12	12mm	12mm



QFM27
Push-In
Nipple

Code	Tube
20-M027-04	4mm
20-M027-06	6mm
20-M027-08	8mm
20-M027-10	10mm
20-M027-12	12mm



QFM13
Male Run
Tee

Code	Tube	Male
20-M013-0402	4mm	1/8 BSPT
20-M013-0404	4mm	1/4 BSPT
20-M013-04M05	4mm	M5x0.8
20-M013-0602	6mm	1/8 BSPT
20-M013-0604	6mm	1/4 BSPT
20-M013-0606	6mm	3/8 BSPT
20-M013-06M05	6mm	M5x0.8
20-M013-0802	8mm	1/8 BSPT
20-M013-0804	8mm	1/4 BSPT
20-M013-0806	8mm	3/8 BSPT
20-M013-0808	8mm	1/2 BSPT
20-M013-1002	10mm	1/8 BSPT
20-M013-1004	10mm	1/4 BSPT
20-M013-1006	10mm	3/8 BSPT
20-M013-1008	10mm	1/2 BSPT
20-M013-1204	12mm	1/4 BSPT
20-M013-1206	12mm	3/8 BSPT
20-M013-1208	12mm	1/2 BSPT
20-M013-1606	16mm	3/8 BSPT
20-M013-1608	16mm	1/2 BSPT

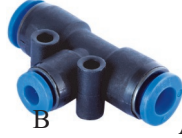

QFM14R
Reducing
Union Tee

Code	Tube A	Tube B
20-M014R-0406	4mm	6mm
20-M014R-0604	6mm	4mm
20-M014R-0608	6mm	8mm
20-M014R-0806	8mm	6mm
20-M014R-0810	8mm	10mm
20-M014R-1006	10mm	6mm
20-M014R-1008	10mm	8mm
20-M014R-1012	10mm	12mm
20-M014R-1208	12mm	8mm
20-M014R-1210	12mm	10mm
20-M014R-1612	16mm	12mm



QFM31
Bulkhead
Tube Union

Code	Tube
20-M031-04	4mm
20-M031-06	6mm
20-M031-08	8mm
20-M031-10	10mm
20-M031-12	12mm
20-M031-16	16mm



QFM14
Union
Tee

Code	Tube
20-M014-04	4mm
20-M014-06	6mm
20-M014-08	8mm
20-M014-10	10mm
20-M014-12	12mm
20-M014-14	14mm
20-M014-16	16mm



QFM15
Female
Elbow

Code	Tube	Female
20-M015-0402	4mm	1/8 BSP
20-M015-0404	4mm	1/4 BSP
20-M015-04M05	4mm	M5x0.8
20-M015-0602	6mm	1/8 BSP
20-M015-0604	6mm	1/4 BSP
20-M015-0606	6mm	3/8 BSP
20-M015-06M05	6mm	M5x0.8
20-M015-0802	8mm	1/8 BSP
20-M015-0804	8mm	1/4 BSP
20-M015-0806	8mm	3/8 BSP
20-M015-1004	10mm	1/4 BSP
20-M015-1006	10mm	3/8 BSP
20-M015-1008	10mm	1/2 BSP
20-M015-1204	12mm	1/4 BSP
20-M015-1206	12mm	3/8 BSP
20-M015-1208	12mm	1/2 BSP

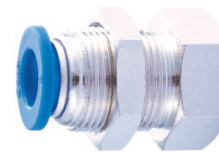

QFM31F
Female
Bulkhead

Code	Tube	Female
20-M031F-0402	4mm	1/8 BSP
20-M031F-0404	4mm	1/4 BSP
20-M031F-0602	6mm	1/8 BSP
20-M031F-0604	6mm	1/4 BSP
20-M031F-0606	6mm	3/8 BSP
20-M031F-0802	8mm	1/8 BSP
20-M031F-0804	8mm	1/4 BSP
20-M031F-0806	8mm	3/8 BSP
20-M031F-0808	8mm	1/2 BSP
20-M031F-1004	10mm	1/4 BSP
20-M031F-1006	10mm	3/8 BSP
20-M031F-1008	10mm	1/2 BSP
20-M031F-1204	12mm	1/4 BSP
20-M031F-1206	12mm	3/8 BSP
20-M031F-1208	12mm	1/2 BSP
20-M031F-1606	16mm	3/8 BSP
20-M031F-1608	16mm	1/2 BSP



IFS also supply nylon, polyurethane, polyethylene and Teflon tube to suit push-in fittings. Refer to Category 14 or contact the sales office for further information.



Push-In Fittings. Metric Tube sizes (Category 20)



QFM33
Tube
Cap

Code	Tube
20-M033-04	4mm
20-M033-06	6mm
20-M033-08	8mm
20-M033-10	10mm
20-M033-12	12mm
20-M033-16	16mm



QFM64
Tube Plug

Code	Tube
20-M064-04	4mm
20-M064-05	5mm
20-M064-06	6mm
20-M064-08	8mm
20-M064-10	10mm
20-M064-12	12mm
20-M064-16	16mm



QFM68
Union
Cross

Code	Tube
20-M068-04	4mm
20-M068-06	6mm
20-M068-08	8mm
20-M068-10	10mm
20-M068-12	12mm



QFM73
Push-In
Reducing Nipple

Code	Tube	Tube
20-M073-0604	6mm	4mm
20-M073-0806	8mm	6mm
20-M073-1008	10mm	8mm
20-M073-1210	12mm	10mm
20-M073-1612	16mm	12mm



QFM75R
Reducing
Union Y

Code	Tube A	Tube B
20-M075R-0604	6mm	4mm
20-M075R-0806	8mm	6mm
20-M075R-1008	10mm	8mm
20-M075R-1210	12mm	10mm



QFM72A
Stem Reducer &
Increaser

Code	Stem	Tube
20-M072A-0406	4mm	6mm
20-M072A-04I02	4mm	1/8
20-M072A-0604	6mm	4mm
20-M072A-0608	6mm	8mm
20-M072A-0804	8mm	4mm
20-M072A-0806	8mm	6mm
20-M072A-0810	8mm	10mm
20-M072A-1004	10mm	4mm
20-M072A-1006	10mm	6mm
20-M072A-1008	10mm	8mm
20-M072A-1012	10mm	12mm
20-M072A-1206	12mm	6mm
20-M072A-1208	12mm	8mm
20-M072A-1210	12mm	10mm
20-M072A-1406	14mm	12mm
20-M072A-1408	14mm	6mm
20-M072A-1410	14mm	8mm
20-M072A-1412	14mm	10mm
20-M072A-1610	16mm	10mm
20-M072A-1612	16mm	12mm



QFM72M
Stem Male
Adaptor

Code	Stem	Male
20-M072M-0402	4mm	1/8 BSPT
20-M072M-0404	4mm	1/4 BSPT
20-M072M-04M05	4mm	M5x0.8
20-M072M-0602	6mm	1/8 BSPT
20-M072M-0604	6mm	1/4 BSPT
20-M072M-0606	6mm	3/8 BSPT
20-M072M-0802	8mm	1/8 BSPT
20-M072M-0804	8mm	1/4 BSPT
20-M072M-0806	8mm	3/8 BSPT
20-M072M-1004	10mm	1/4 BSPT
20-M072M-1006	10mm	3/8 BSPT
20-M072M-1008	10mm	1/2 BSPT
20-M072M-1206	12mm	3/8 BSPT
20-M072M-1208	12mm	1/2 BSPT
20-M072M-1408	14mm	1/2 BSPT
20-M072M-1606	16mm	3/8 BSPT
20-M072M-1608	16mm	1/2 BSPT



QFM75
Union
Y

Code	Tube
20-M075-04	4mm
20-M075-06	6mm
20-M075-08	8mm
20-M075-10	10mm
20-M075-12	12mm
20-M075-16	16mm



QFM75A
Stem Y
Connector

Code	Stem	Tube
20-M075A-04	4mm	4mm
20-M075A-06	6mm	6mm
20-M075AR-0604	6mm	4mm
20-M075A-08	8mm	8mm
20-M075AR-0806	8mm	6mm
20-M075A-10	10mm	10mm
20-M075AR-1008	10mm	8mm
20-M075A-12	12mm	12mm
20-M075AR-1210	12mm	10mm



QFM76
Male Branch
Y

Code	Tube	Male
20-M076-0402	4mm	1/8 BSPT
20-M076-0404	4mm	1/4 BSPT
20-M076-04M05	4mm	M5x0.8
20-M076-0602	6mm	1/8 BSPT
20-M076-0604	6mm	1/4 BSPT
20-M076-0606	6mm	3/8 BSPT
20-M076-06M05	6mm	M5x0.8
20-M076-0802	8mm	1/8 BSPT
20-M076-0804	8mm	1/4 BSPT
20-M076-0806	8mm	3/8 BSPT
20-M076-0808	8mm	1/2 BSPT
20-M076-1002	10mm	1/8 BSPT
20-M076-1004	10mm	1/4 BSPT
20-M076-1006	10mm	3/8 BSPT
20-M076-1008	10mm	1/2 BSPT
20-M076-1204	12mm	1/4 BSPT
20-M076-1206	12mm	3/8 BSPT
20-M076-1208	12mm	1/2 BSPT

Other Styles available by request. Contact the sales office for details.



Nickel Plated Brass Push-In Fittings. Imperial (Category 21)



**BQF3
Male
Connector**

Code	Tube	Male
21-003-0202	1/8	1/8 BSPT
21-003-0204	1/8	1/4 BSPT
21-003-02N02	1/8	1/8 NPT
21-003-0302	3/16	1/8 BSPT
21-003-0304	3/16	1/4 BSPT
21-003-0402	1/4	1/8 BSPT
21-003-0404	1/4	1/4 BSPT
21-003-04N02	1/4	1/8 NPT
21-003-04N04	1/4	1/4 NPT
21-003-0602	3/8	1/8 BSPT
21-003-0604	3/8	1/4 BSPT
21-003-0606	3/8	3/8 BSPT
21-003-0608	3/8	1/2 BSPT
21-003-06N04	3/8	1/4 NPT
21-003-0804	1/2	1/4 BSPT
21-003-0806	1/2	3/8 BSPT
21-003-0808	1/2	1/2 BSPT



**BQF4
Tube
Union**

Code	Tube
21-004-02	1/8
21-004-03	3/16
21-004-04	1/4
21-004-06	3/8
21-004-08	1/2.



**BQF5A
Stem Elbow
Connector**

Code	Stem.	Tube
21-005A-02	1/8	1/8
21-005A-04	1/4	1/4
21-005A-06	3/8	3/8
21-005A-08	1/2	1/2

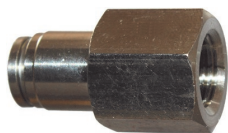

**BQF10
Female
Connector**

Code	Tube	Female
21-010-0402	1/4	1/8 BSP
21-010-0404	1/4	1/4 BSP
21-010-0604	3/8	1/4 BSP
21-010-0606	3/8	3/8 BSP
21-010-0808	1/2	1/2 BSP



**BQF5
Male Elbow
Connector**

Code	Tube	Male
21-005-0202	1/8	1/8 BSPT
21-005-025N02	5/32	1/8 NPT
21-005-02N02	1/8	1/8 NPT
21-005-0302	3/16	1/8 BSPT
21-005-0304	3/16	1/4 BSPT
21-005-0402	1/4	1/8 BSPT
21-005-0404	1/4	1/4 BSPT
21-005-0406	1/4	3/8 BSPT
21-005-04N02	1/4	1/8 NPT
21-005-04N04	1/4	1/4 NPT
21-005-05N02	5/16	1/8 NPT
21-005-05N04	5/16	1/4 NPT
21-005-0604	3/8	1/4 BSPT
21-005-0606	3/8	3/8 BSPT
21-005-0608	3/8	1/2 BSPT
21-005-06N04	3/8	1/4 NPT
21-005-06N06	3/8	3/8 NPT
21-005-0804	1/2	1/4 BSPT
21-005-0806	1/2	3/8 BSPT
21-005-0808	1/2	1/2 BSPT



**BQF11
Union
Elbow**

Code	Tube
21-011-02	1/8
21-011-03	3/16
21-011-04	1/4
21-011-06	3/8
21-011-08	1/2.



**BQF12
Male Branch
Tee**

Code	Tube	Male
21-012-0202	1/8	1/8 BSPT
21-012-0302	3/16	1/8 BSPT
21-012-0304	3/16	1/4 BSPT
21-012-0402	1/4	1/8 BSPT
21-012-0404	1/4	1/4 BSPT
21-012-0604	3/8	1/4 BSPT
21-012-0606	3/8	3/8 BSPT
21-012-0804	1/2	1/4 BSPT
21-012-0806	1/2	3/8 BSPT
21-012-0808	1/2	1/2 BSPT



**BQF13
Male Run
Tee**

Code	Tube	Male
21-013-0404	1/4	1/4 BSPT
21-013-0606	3/8	3/8 BSPT
21-013-0808	1/2	1/2 BSPT



**BQF14
Union
Tee**

Code	Tube
21-014-02	1/8
21-014-03	3/16
21-014-04	1/4
21-014-06	3/8
21-014-08	1/2.



**BQFM27
Push-In
Nipple**

Code	Tube
21-027-08	1/2



**BQF31
Bulkhead
Tube Union**

Code	Tube
21-031-04	1/4
21-031-06	3/8
21-031-08	1/2.



**BQF31F
Female Bulkhead
Connector**

Code	Tube	Female
21-031F-0404	1/4	1/4 BSP
21-031F-0606	3/8	3/8 BSP
21-031F-0808	1/2	1/2 BSP



**BQF33
Tube Cap**

Code	Tube
21-033-04	1/4
21-033-06	3/8
21-033-08	1/2.

Nickel Plated Brass Push-In Fittings. Imperial (Category 21)



BQF64
Tube Plug

Code	Tube
21-064-04	1/4
21-064-06	3/8
21-064-08	1/2.



BQF75
Union Y

Code	Tube
21-075-04	1/4
21-075-06	3/8
21-075-08	1/2.

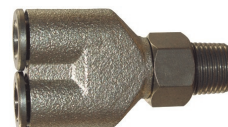

BQF76
Male Branch
Y

Code	Tube	Male
21-076-0204	1/8	1/4 BSPT
21-076-0304	3/16	1/4 BSPT
21-076-0404	1/4	1/4 BSPT
21-076-0406	1/4	3/8 BSPT
21-076-0606	3/8	3/8 BSPT
21-076-0806	1/2	3/8 BSPT
21-076-0808	1/2	1/2 BSPT



BQF72A
Stem Reducer
& Increaser

Code	Stem.	Tube
21-072A-0402	1/4	1/8
21-072A-0604	3/8	1/4
21-072A-0806	1/2	3/8

Push-In Fittings also available in Stainless Steel. Refer to Category 23 or contact the sales office for further details.

Nickel Plated Brass Push-In Fittings. Metric (Category 21)



BQFM3
Male
Connector

Code	Tube	Male
21-M003-03M03	3mm	M3x0.5
21-M003-03M05	3mm	M5x0.8
21-M003-0402	4mm	1/8 BSPT
21-M003-0404	4mm	1/4 BSPT
21-M003-04M05	4mm	M5x0.8
21-M003-04M06	4mm	M6x1.0
21-M003-04P02	4mm	1/8 BSPP
21-M003-0502	5mm	1/8 BSPT
21-M003-0504	5mm	1/4 BSPT
21-M003-05M05	5mm	M5x0.8
21-M003-0602	6mm	1/8 BSPT
21-M003-0604	6mm	1/4 BSPT
21-M003-0606	6mm	3/8 BSPT
21-M003-0608	6mm	1/2 BSPT
21-M003-06M05	6mm	M5x0.8
21-M003-06P04	6mm	1/4 BSPP
21-M003-0802	8mm	1/8 BSPT
21-M003-0804	8mm	1/4 BSPT
21-M003-0806	8mm	3/8 BSPT
21-M003-0808	8mm	1/2 BSPT
21-M003-08P04	8mm	1/4 BSPP
21-M003-1002	10mm	1/8 BSPT
21-M003-1004	10mm	1/4 BSPT
21-M003-1006	10mm	3/8 BSPT
21-M003-1008	10mm	1/2 BSPT
21-M003-10P06	10mm	3/8 BSPP
21-M003-1204	12mm	1/4 BSPT
21-M003-1206	12mm	3/8 BSPT
21-M003-1208	12mm	1/2 BSPT
21-M003-12P04	12mm	1/4 BSPP
21-M003-12P08	12mm	1/2 BSPP



BQFM3 (Cont)
Male
Connector

Code	Tube	Male
21-M003-1406	14mm	3/8 BSPT
21-M003-1408	14mm	1/2 BSPT
21-M003-1606	16mm	3/8 BSPT
21-M003-1608	16mm	1/2 BSPT



BQFM4
Tube
Union

Code	Tube
21-M004-03	3mm
21-M004-04	4mm
21-M004-05	5mm
21-M004-06	6mm
21-M004-08	8mm
21-M004-10	10mm
21-M004-12	12mm
21-M004-14	14mm
21-M004-16	16mm



BQFM4R
Reducing Tube
Union

Code	Tube	Tube
21-M004R-0604	6mm	4mm
21-M004R-0806	8mm	6mm
21-M004R-1006	10mm	6mm
21-M004R-1008	10mm	8mm



BQFM5
Male Elbow
Connector

Code	Tube	Male
21-M005-03M03	3mm	M3x0.5
21-M005-03M05	3mm	M5x0.8
21-M005-0402	4mm	1/8 BSPT
21-M005-0404	4mm	1/4 BSPT
21-M005-04M05	4mm	M5x0.8
21-M005-04P02	4mm	1/8 BSPP
21-M005-0502	5mm	1/8 BSPT
21-M005-0504	5mm	1/4 BSPT
21-M005-05M05	5mm	M5x0.8
21-M005-0602	6mm	1/8 BSPT
21-M005-0604	6mm	1/4 BSPT
21-M005-0606	6mm	3/8 BSPT
21-M005-06M05	6mm	M5x0.8
21-M005-06P02	6mm	1/8 BSPP
21-M005-0802	8mm	1/8 BSPT
21-M005-0804	8mm	1/4 BSPT
21-M005-0806	8mm	3/8 BSPT
21-M005-0808	8mm	1/2 BSPT
21-M005-08P04	8mm	1/4 BSPP
21-M005-1002	10mm	1/8 BSPT
21-M005-1004	10mm	1/4 BSPT
21-M005-1006	10mm	3/8 BSPT
21-M005-1008	10mm	1/2 BSPT
21-M005-10P04	10mm	1/4 BSPP
21-M005-1204	12mm	1/4 BSPT
21-M005-1206	12mm	3/8 BSPT
21-M005-1208	12mm	1/2 BSPT
21-M005-1406	14mm	3/8 BSPT
21-M005-1408	14mm	1/2 BSPT
21-M005-1606	16mm	3/8 BSPT
21-M005-1608	16mm	1/2 BSPT

Nickel Plated Brass Push-In Fittings. Metric (Category 21)



BQFM5A
Stem Elbow
Connector

Code	Stem.	Tube
21-M005A-04	4mm	4mm
21-M005A-06	6mm	6mm
21-M005A-08	8mm	8mm
21-M005A-10	10mm	10mm
21-M005A-12	12mm	12mm

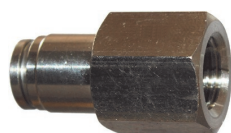

BQFM10
Female
Connector

Code	Tube	Female
21-M010-0402	4mm	1/8 BSP
21-M010-0404	4mm	1/4 BSP
21-M010-04M05	4mm	M5x0.8
21-M010-0502	5mm	1/8 BSP
21-M010-0602	6mm	1/8 BSP
21-M010-0604	6mm	1/4 BSP
21-M010-0802	8mm	1/8 BSP
21-M010-0804	8mm	1/4 BSP
21-M010-0806	8mm	3/8 BSP
21-M010-1004	10mm	1/4 BSP
21-M010-1006	10mm	3/8 BSP
21-M010-1008	10mm	1/2 BSP
21-M010-1206	12mm	3/8 BSP
21-M010-1208	12mm	1/2 BSP



BQFM11
Union
Elbow

Code	Tube
21-M011-03	3mm
21-M011-04	4mm
21-M011-05	5mm
21-M011-06	6mm
21-M011-08	8mm
21-M011-10	10mm
21-M011-12	12mm
21-M011-14	14mm
21-M011-16	16mm



IFS also have a range of silencers in brass, stainless steel and plastic.

Refer to category 26 or contact the sales office for further details.



BQFM12
Male Branch
Tee

Code	Tube	Male
21-M012-03M03	3mm	M3x0.5
21-M012-03M05	3mm	M5x0.8
21-M012-0402	4mm	1/8 BSPT
21-M012-0404	4mm	1/4 BSPT
21-M012-04M05	4mm	M5x0.8
21-M012-0502	5mm	1/8 BSPT
21-M012-0504	5mm	1/4 BSPT
21-M012-05M05	5mm	M5x0.8
21-M012-0602	6mm	1/8 BSPT
21-M012-0604	6mm	1/4 BSPT
21-M012-06M05	6mm	M5x0.8
21-M012-0802	8mm	1/8 BSPT
21-M012-0804	8mm	1/4 BSPT
21-M012-0806	8mm	3/8 BSPT
21-M012-08P02	8mm	1/8 BSPP
21-M012-1002	10mm	1/8 BSPT
21-M012-1004	10mm	1/4 BSPT
21-M012-1006	10mm	3/8 BSPT
21-M012-1008	10mm	1/2 BSPT
21-M012-1204	12mm	1/4 BSPT
21-M012-1206	12mm	3/8 BSPT
21-M012-1208	12mm	1/2 BSPT
21-M012-1406	14mm	3/8 BSPT
21-M012-1408	14mm	1/2 BSPT
21-M012-1606	16mm	3/8 BSPT
21-M012-1608	16mm	1/2 BSPT



BQFM13
Male Run
Tee

Code	Tube	Male
21-M013-03M03	3mm	M3x0.5
21-M013-03M05	3mm	M5x0.8
21-M013-0402	4mm	1/8 BSPT
21-M013-0404	4mm	1/4 BSPT
21-M013-04M05	4mm	M5x0.8
21-M013-0502	5mm	1/8 BSPT
21-M013-05M05	5mm	M5x0.8
21-M013-0602	6mm	1/8 BSPT
21-M013-0604	6mm	1/4 BSPT
21-M013-0802	8mm	1/8 BSPT
21-M013-0804	8mm	1/4 BSPT
21-M013-0806	8mm	3/8 BSPT
21-M013-1004	10mm	1/4 BSPT
21-M013-1006	10mm	3/8 BSPT
21-M013-1008	10mm	1/2 BSPT
21-M013-1206	12mm	3/8 BSPT
21-M013-1208	12mm	1/2 BSPT
21-M013-1408	14mm	1/2 BSPT



BQFM14
Union
Tee

Code	Tube
21-M014-03	3mm
21-M014-04	4mm
21-M014-05	5mm
21-M014-06	6mm
21-M014-08	8mm
21-M014-10	10mm
21-M014-12	12mm
21-M014-14	14mm
21-M014-16	16mm



BQFM31
Bulkhead
Tube Union

Code	Tube
21-M031-03	3mm
21-M031-04	4mm
21-M031-05	5mm
21-M031-06	6mm
21-M031-08	8mm
21-M031-10	10mm
21-M031-12	12mm
21-M031-14	14mm
21-M031-16	16mm



BQFM31F
Female Bulkhead
Connector

Code	Tube	Female
21-M031F-0402	4mm	1/8 BSP
21-M031F-0404	4mm	1/4 BSP
21-M031F-0602	6mm	1/8 BSP
21-M031F-0604	6mm	1/4 BSP
21-M031F-0802	8mm	1/8 BSP
21-M031F-0804	8mm	1/4 BSP
21-M031F-0806	8mm	3/8 BSP
21-M031F-1004	10mm	1/4 BSP
21-M031F-1006	10mm	3/8 BSP
21-M031F-1008	10mm	1/2 BSP
21-M031F-1206	12mm	3/8 BSP
21-M031F-1208	12mm	1/2 BSP
21-M031F-1606	16mm	3/8 BSP
21-M031F-1608	16mm	1/2 BSP

Nickel Plated Brass Push-In Fittings. Metric (Category 21)



**BQFM33
Tube Cap**

Code	Tube
21-M033-04	4mm
21-M033-06	6mm
21-M033-08	8mm
21-M033-10	10mm
21-M033-12	12mm
21-M033-16	16mm



**BQFM64
Tube Plug**

Code	Tube
21-M064-04	4mm
21-M064-05	5mm
21-M064-06	6mm
21-M064-08	8mm
21-M064-10	10mm
21-M064-12	12mm
21-M064-16	16mm



**BQFM68
Union Cross**

Code	Tube
21-M068-04	4mm
21-M068-05	5mm
21-M068-06	6mm
21-M068-08	8mm
21-M068-10	10mm
21-M068-12	12mm



**BQFM72A
Stem Reducer
& Increaser**

Code	Stem.	Tube
21-M072A-0403	4mm	3mm
21-M072A-0406	4mm	6mm
21-M072A-0504	5mm	4mm
21-M072A-0604	6mm	4mm
21-M072A-0605	6mm	5mm
21-M072A-0608	6mm	8mm
21-M072A-06I04	6mm	1/4
21-M072A-0804	8mm	4mm
21-M072A-0805	8mm	5mm
21-M072A-0806	8mm	6mm
21-M072A-1006	10mm	6mm
21-M072A-1008	10mm	8mm
21-M072A-10I06	10mm	3/8
21-M072A-1206	12mm	6mm
21-M072A-1208	12mm	8mm
21-M072A-1210	12mm	10mm
21-M072A-12I08	12mm	1/2
21-M072A-1410	14mm	10mm
21-M072A-1412	14mm	12mm

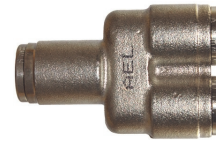

**BQFM75
Union Y**

Code	Tube
21-M075-03	3mm
21-M075-04	4mm
21-M075-06	6mm
21-M075-08	8mm
21-M075-10	10mm
21-M075-12	12mm
21-M075-16	16mm

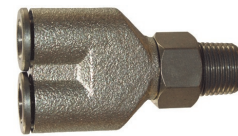

**BQFM76
Male Branch
Y**

Code	Tube	Male
21-M076-0402	4mm	1/8 BSPT
21-M076-04M05	4mm	M5x0.8
21-M076-0602	6mm	1/8 BSPT
21-M076-06M05	6mm	M5x0.8
21-M076-0802	8mm	1/8 BSPT
21-M076-0804	8mm	1/4 BSPT

We also stock Polyurethane and Nylon Spiral Coils.

Refer Category 43 or contact the sales office for further details.

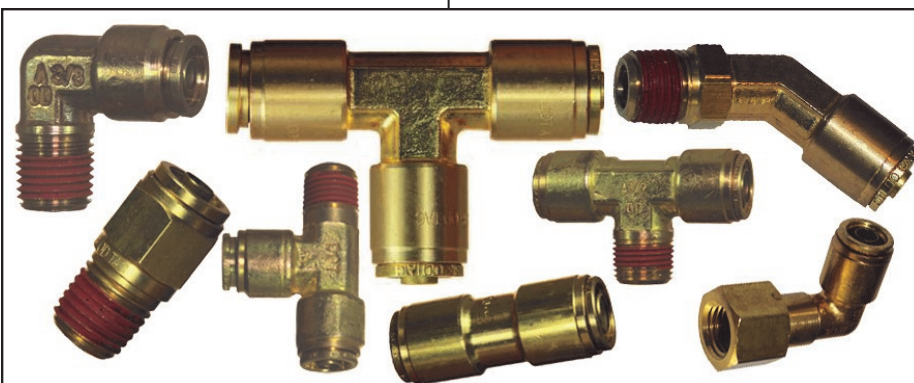

We also stock a full range of D.O.T. approved airbrake push-in fittings.

Refer to Category 88 or contact the sales office for further details.

Do you need a thread sealant? We stock various types of thread tape and a full range of Bondloc thread lockers and sealants.



Stainless Steel Push-In Fittings. Imperial (Category 23)



Male Connector

Code	Tube	Male
23-003-0202	1/8	1/8 BSPT
23-003-0204	1/8	1/4 BSPT
23-003-02M05	1/8	M5x0.8
23-003-0302	3/16	1/8 BSPT
23-003-0402	1/4	1/8 BSPT
23-003-0404	1/4	1/4 BSPT
23-003-0406	1/4	3/8 BSPT
23-003-0604	3/8	1/4 BSPT
23-003-0606	3/8	3/8 BSPT
23-003-0608	3/8	1/2 BSPT
23-003-0806	1/2	3/8 BSPT
23-003-0808	1/2	1/2 BSPT



Tube Union

Code	Tube
23-004-02	1/8
23-004-03	3/16
23-004-04	1/4
23-004-06	3/8
23-004-08	1/2



Reducing Tube Union

Code	Tube	Tube
23-004R-0504	5/16	1/4
23-004R-0605	3/8	5/16
23-004R-0806	1/2	3/8



Male Elbow Connector

Code	Tube	Male
23-005-0202	1/8	1/8 BSPT
23-005-0204	1/8	1/4 BSPT
23-005-02M05	1/8	M5x0.8
23-005-0302	3/16	1/8 BSPT
23-005-0402	1/4	1/8 BSPT
23-005-0404	1/4	1/4 BSPT
23-005-0604	3/8	1/4 BSPT
23-005-0606	3/8	3/8 BSPT
23-005-0806	1/2	3/8 BSPT
23-005-0808	1/2	1/2 BSPT



Female Connector

Code	Tube	Female
23-010-0202	1/8	1/8 BSP



Tube Union Elbow

Code	Tube
23-011-02	1/8
23-011-03	3/16
23-011-04	1/4
23-011-06	3/8
23-011-08	1/2



Male Branch Tee

Code	Tube	Male
23-012-0202	1/8	1/8 BSPT
23-012-0204	1/8	1/4 BSPT
23-012-02M05	1/8	M5x0.8
23-012-0404	1/4	1/4 BSPT
23-012-0606	3/8	3/8 BSPT
23-012-0808	1/2	1/2 BSPT



Tube Union Tee

Code	Tube
23-014-02	1/8
23-014-03	3/16
23-014-04	1/4
23-014-06	3/8
23-014-08	1/2



Bulkhead Tube Union

Code	Tube
23-031-02	1/8
23-031-03	3/16
23-031-04	1/4
23-031-06	3/8
23-031-08	1/2

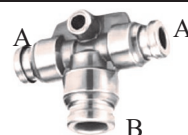

Reducing Tube Union Tee

Code	Tube A	Tube B
23-014R-02M04	1/8	4mm



Female Bulkhead Connector

Code	Tube	Female
23-031F-0204	1/8	1/4 BSP



Tube Plug

Code	Tube
23-064-02	1/8
23-064-04	1/4
23-064-06	3/8
23-064-08	1/2



Stem Reducer

Code	Stem	Tube
23-072A-0504	5/16	1/4
23-072A-0605	3/8	5/16
23-072A-0806	1/2	3/8



Tube Union Y

Code	Tube
23-075-02	1/8
23-075-04	1/4
23-075-06	3/8
23-075-08	1/2



Stainless Steel Twin Ferrule Compression Fittings also available. Refer to Category 29

Stainless Steel Push-In Fittings. Metric (Category 23)



Male
Connector

Code	Tube	Male
23-M003-0402	4mm	1/8 BSPT
23-M003-0404	4mm	1/4 BSPT
23-M003-04M05	4mm	M5x0.8
23-M003-0602	6mm	1/8 BSPT
23-M003-0604	6mm	1/4 BSPT
23-M003-0606	6mm	3/8 BSPT
23-M003-06M05	6mm	M5x0.8
23-M003-0802	8mm	1/8 BSPT
23-M003-0804	8mm	1/4 BSPT
23-M003-0806	8mm	3/8 BSPT
23-M003-0808	8mm	1/2 BSPT
23-M003-1002	10mm	1/8 BSPT
23-M003-1004	10mm	1/4 BSPT
23-M003-1006	10mm	3/8 BSPT
23-M003-1008	10mm	1/2 BSPT
23-M003-1204	12mm	1/4 BSPT
23-M003-1206	12mm	3/8 BSPT
23-M003-1208	12mm	1/2 BSPT
23-M003-1606	16mm	3/8 BSPT
23-M003-1608	16mm	1/2 BSPT



Male Elbow
Connector

Code	Tube	Male
23-M005-0402	4mm	1/8 BSPT
23-M005-0404	4mm	1/4 BSPT
23-M005-04M05	4mm	M5x0.8
23-M005-0602	6mm	1/8 BSPT
23-M005-0604	6mm	1/4 BSPT
23-M005-0606	6mm	3/8 BSPT
23-M005-06M05	6mm	M5x0.8
23-M005-0802	8mm	1/8 BSPT
23-M005-0804	8mm	1/4 BSPT
23-M005-0806	8mm	3/8 BSPT
23-M005-1002	10mm	1/8 BSPT
23-M005-1004	10mm	1/4 BSPT
23-M005-1006	10mm	3/8 BSPT
23-M005-1008	10mm	1/2 BSPT
23-M005-1204	12mm	1/4 BSPT
23-M005-1206	12mm	3/8 BSPT
23-M005-1208	12mm	1/2 BSPT
23-M005-1606	16mm	3/8 BSPT
23-M005-1608	16mm	1/2 BSPT



Tube
Union
Elbow

Code	Tube
23-M011-04	4mm
23-M011-06	6mm
23-M011-08	8mm
23-M011-10	10mm
23-M011-12	12mm
23-M011-16	16mm



Male
Branch
Tee

Code	Tube	Male
23-M012-0402	4mm	1/8 BSPT
23-M012-0404	4mm	1/4 BSPT
23-M012-04M05	4mm	M5x0.8
23-M012-0602	6mm	1/8 BSPT
23-M012-0604	6mm	1/4 BSPT
23-M012-0606	6mm	3/8 BSPT
23-M012-06M05	6mm	M5x0.8
23-M012-0802	8mm	1/8 BSPT
23-M012-0804	8mm	1/4 BSPT
23-M012-0806	8mm	3/8 BSPT
23-M012-1002	10mm	1/8 BSPT
23-M012-1004	10mm	1/4 BSPT
23-M012-1006	10mm	3/8 BSPT
23-M012-1008	10mm	1/2 BSPT
23-M012-1204	12mm	1/4 BSPT
23-M012-1206	12mm	3/8 BSPT
23-M012-1208	12mm	1/2 BSPT
23-M012-1606	16mm	3/8 BSPT
23-M012-1608	16mm	1/2 BSPT



Tube
Union

Code	Tube
23-M004-04	4mm
23-M004-06	6mm
23-M004-08	8mm
23-M004-10	10mm
23-M004-12	12mm
23-M004-16	16mm



Female
Connector

Code	Tube	Female
23-M010-0402	4mm	1/8 BSP
23-M010-0404	4mm	1/4 BSP
23-M010-0602	6mm	1/8 BSP
23-M010-0604	6mm	1/4 BSP
23-M010-0606	6mm	3/8 BSP
23-M010-0802	8mm	1/8 BSP
23-M010-0804	8mm	1/4 BSP
23-M010-0806	8mm	3/8 BSP
23-M010-1004	10mm	1/4 BSP
23-M010-1006	10mm	3/8 BSP
23-M010-1204	12mm	1/4 BSP
23-M010-1206	12mm	3/8 BSP
23-M010-1606	16mm	3/8 BSP
23-M010-1608	16mm	1/2 BSP



Tube
Union
Tee

Code	Tube
23-M014-04	4mm
23-M014-06	6mm
23-M014-08	8mm
23-M014-10	10mm
23-M014-12	12mm
23-M014-16	16mm



Reducing
Tube
Union

Code	Tube	Tube
23-M004R-04I02	4mm	1/8
23-M004R-0604	6mm	4mm
23-M004R-0806	8mm	6mm
23-M004R-1008	10mm	8mm
23-M004R-1210	12mm	10mm
23-M004R-1612	16mm	12mm

Stainless Steel Push-In Fittings. Metric (Category 23)

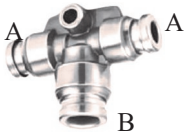

Reducing Tube Union Tee

Code	Tube A	Tube B
23-M014R-0406	4mm	6mm
23-M014R-0608	6mm	8mm
23-M014R-0810	8mm	10mm
23-M014R-1012	10mm	12mm
23-M014R-1216	12mm	16mm



Bulkhead Tube Union

Code	Tube
23-M031-04	4mm
23-M031-06	6mm
23-M031-08	8mm
23-M031-10	10mm
23-M031-12	12mm
23-M031-16	16mm



Stem Reducer

Code	Stem	Tube
23-M072A-04I02	4mm	1/8
23-M072A-0604	6mm	4mm
23-M072A-0806	8mm	6mm
23-M072A-1008	10mm	8mm
23-M072A-1210	12mm	10mm
23-M072A-1612	16mm	12mm



Female Bulkhead Connector

Code	Tube	Female
23-M031F-0402	4mm	1/8 BSP
23-M031F-0404	4mm	1/4 BSP
23-M031F-0602	6mm	1/8 BSP
23-M031F-0604	6mm	1/4 BSP
23-M031F-0606	6mm	3/8 BSP
23-M031F-0802	8mm	1/8 BSP
23-M031F-0804	8mm	1/4 BSP
23-M031F-0806	8mm	3/8 BSP
23-M031F-1004	10mm	1/4 BSP
23-M031F-1006	10mm	3/8 BSP
23-M031F-1206	12mm	3/8 BSP
23-M031F-1208	12mm	1/2 BSP
23-M031F-1606	16mm	3/8 BSP
23-M031F-1608	16mm	1/2 BSP



Tube Plug

Code	Tube
23-M064-04	4mm
23-M064-06	6mm
23-M064-08	8mm
23-M064-10	10mm
23-M064-12	12mm
23-M064-16	16mm

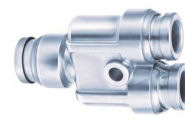

Tube Union Y

Code	Tube
23-M075-04	4mm
23-M075-06	6mm
23-M075-08	8mm
23-M075-10	10mm
23-M075-12	12mm
23-M075-16	16mm



PTFE and FEP140 Tube also available, along with nylon, polyurethane and polyethylene.

Refer to Category 14

We also stock a full range of 316 Stainless Steel screwed adaptors, hose tails and weld on nipples.

Refer to Category 31 or contact the sales office for further details.

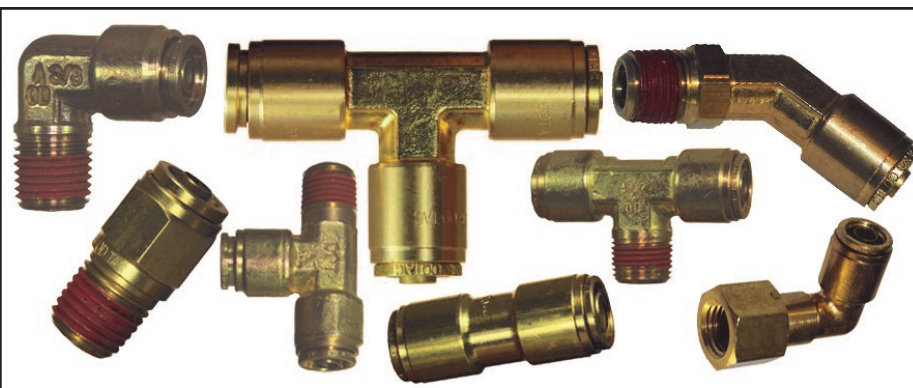

We also stock a full range of D.O.T. approved airbrake push-in fittings.

Refer to Category 88 or contact the sales office for further details.

Thread Sealants & Lockers. (Category 24)



Manufactured in England since 1992, Bondloc offers a comprehensive range of adhesives, thread lockers and sealants to meet all of your requirements.

Thread Sealants

B542 Hydraulic Sealant is a medium strength thixotropic liquid which cures anaerobically to form a tough, high pressure seal on all types of threaded couplings used on low, medium and high pressure lines. Used on all types of hydraulic connections. Seals up to 400bar on 3/4 fittings. Easily dismantled with hand tools.



Code	Tube Size
24-B542-050	50ml
24-B542-250	250ml

B569 Hydraulic Sealant is a high strength thixotropic liquid which cures anaerobically to form a tough, high pressure seal on all types of threaded couplings used on low, medium and high pressure lines. Ideal for finer threads used in hydraulic and pneumatic applications requiring zero contamination. Seals up to 400bar on 20mm fittings. Can be dismantled with tools or excessive heat.



Code	Tube Size
24-B569-050	50ml

B567 is an easy to break sealing and locking action product that gives an instant low pressure seal. It provides an instant seal up to 1000psi and seals up to 10000psi when fully cured. The fast curing time allows quick assembly and prevents galling. It has excellent solvent resistance and withstands temperatures up to 204°C. It is ideal for stainless steel, aluminium, galvanized metal and other inert metals.



Code	Tube Size
24-B567-065	65ml
24-B567-250	250ml

B577 Pipe Sealant is an AGA Approved high viscosity thixotropic gel paste which cures rapidly, sealing instantly to 10bar. When cured it resists pressure up to 350bar. It has good chemical/solvent resistance to ethanol, motor oil, unleaded petrol, acetone and brake fluid. Suitable for gas.



AGA approval 7714

Code	Tube Size
24-B577-050	50ml
24-B577-250	250ml

Anti-Seize

The Bondloc Anti-Seize range has been developed to protect metal parts from corrosion, galling and seizing and reduces wear in heavy pressure applications. Mated parts can be removed more easily and in a clean condition.



B771 Nickel Anti-Seize is a Graphite and nickel fortified lubricant. Withstands temperatures from -54°C to 1500°C. Lubricates and seals in harsh chemical environments. Recommended for metal fittings and pipe threads in environments where a clean inert lubricant is required.

Code	Can Size
24-B771-500	500g Brushtop

B772 Copper Anti-Seize is a Graphite and copper fortified lubricant. Protects metal parts from high temperature, seizing, galling and corrosion at temperatures from -30°C to 1000°C. Copper antiseize can be used on copper, brass, cast iron, steel, all alloys including stainless steel. Can also be used on plastics and all non metallic parts.

Code	Can Size
24-B772-500	500g Brushtop

B773 Silver Anti-Seize is a Graphite and metallic flake fortified lubricant. Withstands temperatures from -54°C to 1100°C. A heavy duty, general purpose lubricant, recommended for close tolerance assemblies, fine threads and tight slip fits. Specifically designed for the same applications as Copper Anti Seize but where there is a prejudice against the presence of copper or lead. It is particularly recommended for use where contact with chemicals that react with copper is likely to be experienced and where lead must be excluded from possible contact with foodstuffs and potable water.

Code	Can Size
24-B773-500	500g Brushtop

Thread Sealants & Lockers. (Category 24)

BONDLOC Thread Lockers

B222 Screwlock (Low strength Purple thread locker.)

Ideal for low strength threadlocking where easy disassembly may be required. Used on all small fasteners to prevent loosening through vibration and where sealing through thread fastening is required.

Code	Tube Size
24-B222-010	10ml
24-B222-050	50ml



B272 Studlock (High Strength/High Temp Red thread locker)

Permanent thread locker, suitable for high temperature applications (230°C). It is ideal for locking of large studs and bolts up to 1½". It is resistant to fuels, lubricants and most industrial liquids and gases.

Code	Tube Size
24-B272-010	10ml
24-B272-050	50ml



B243 Threadlock (Medium Strength Blue thread locker)

Oil tolerant B243 is designed for direct application onto "as received" parts where a light oily film exists or where surrounding parts contamination is a problem.

Code	Tube Size
24-B243-010	10ml
24-B243-050	50ml



B277 Studlock (Very High Strength Red thread locker)

is a permanent thread locker. Used in high strength applications on fasteners up to 1" in size. It is chemical resistant, resisting fuels, lubricants and most industrial liquids and gases.

Code	Tube Size
24-B277-010	10ml
24-B277-050	50ml



B270 Studlocker (High Strength Green thread locker)

A general purpose adhesive for permanent threaded assemblies. B270 locks studs up to 1", sealing against leakage and corrosion. It is chemical resistant, resisting fuels, lubricants and most industrial liquids and gases.

Code	Tube Size
24-B270-010	10ml
24-B270-050	50ml



B290 Penetrator (Wick in grade Green thread locker)

Fast cure anaerobic securing compound, very low in viscosity, thus enabling the wicking action to search into the voids in assembled components and cures anaerobically. B290 can also be used as a weld or porosity sealant.

Code	Tube Size
24-B290-010	10ml
24-B290-025	25ml



BONDLOC Primers / Activators

B7471 Anaerobic Activator

Used to increase the cure speed of anaerobic products. It is especially recommended for applications with inactive or passive metals or large bonding gaps. B7471 is also recommended where the temperature is low (<15°C).

B7471 is an Acetone based solvent.

Code	Can Size
24-B7471-100	100ml



B7649 Anaerobic Activator

Used to increase the cure speed of anaerobic products. It is especially recommended for applications with inactive or passive metals or large bonding gaps. B7649 is also recommended where the temperature is low (<15°C).

B7649 is a Heptane based solvent

Code	Can Size
24-B7649-100	100ml



Thread Sealants & Lockers. (Category 24)

BONDLOC Retainers

B603 is an oil tolerant Anaerobic formulation designed for direct use on as received parts such as those with oily films. B603 is used as a conventional high strength retainer on cleaned parts with strengths up to 28N/mm² or as an all purpose locker on oily parts with >20N/mm². Where possible remove thick deposits of grease or dirt, however B603 will penetrate the film once it has been tightened.

- Hold time: <15mins
- Static shear strength (degreased): 25N/mm²
- Static shear strength (oiled film): 21N/mm²
- Use of primers not recommended.



Code	Tube Size
24-B603-010	10ml
24-B603-050	50ml

B641 Bearing fit is medium strength retaining compound. It will secure all types and sizes of bearings, shafts and cylindrical parts which require disassembly in the future.

- Provides a fast hold time: <15mins
- Cure time: 12hrs
- Shear strength of 12N/mm²



Code	Tube Size
24-B641-050	50ml

B680 is a high strength anaerobic adhesive. It gives best resistance to dynamic, axial and radial loads. Recommended for retaining shafts, gears, pulleys and other cylindrical parts. B680 has a medium viscosity which can fill gaps up to 0.2mm

- Provides a fast hold time: 5mins
- Short cure time: 24hrs
- Static shear of 30N/mm



Code	Tube Size
24-B680-010	10ml
24-B680-050	50ml

B638 is designed to give High Strength Retention under cyclic loading. B638 will retain it's full strength and not suffer fatigue under load stress. It is suited to structural components such as cylindrical parts under dynamic load, keys, splines and even structural tubing with close tolerance fit.

- Provides a fast hold time: 5-7mins
- Short cure time: 6hrs
- Static shear strength of 30N/mm²



Code	Tube Size
24-B638-050	50ml

B648 is recommended for High Strength securing where continuous working temperature is rated up to 180°C. B648 is a medium viscosity retainer dealing with gaps up to 0.15mm. It is used for securing all types of cylindrical parts such as bearings, gears, splines, pulleys and keyways. Also suitable on stainless steel parts.

- Provides a fast hold time: 5-15mins
- Short cure time: 2-6hrs
- Static shear of 25N/mm



Code	Tube Size
24-B648-050	50ml
24-B648-250	250ml

B660 Metal Fill Retainer is a press fit repair compound designed to quickly refit worn parts and reach handling strength fast. It is a metallic silver/grey cream which is non run and is used to fill and repair spin out, fretting and small imperfections on close fitting metal parts to enable temporary repairs.



Code	Tube Size
24-B660-050	50ml

BONDLOC Grease Monkey Hand Cleaners

Grease Monkey is a semi-gel skin cleaner that rapidly and effectively removes oil, grease, household paints, general dirt and grime without exposing the user to harsh petroleum based products. Based on natural citrus extracts, which clean well and improve user acceptability.

- Does not contain petroleum based solvents
- Can be used daily because of its mildness
- Works with hot and cold water
- Pleasant citrus smell on hands
- Massaging action of the poly beads helps remove soil
- Beads will not cause drain blocking
- Contains sanitisers and skin emollients

Code	Pack Size
24-BGM-500	500ml
24-BGM-L05	5 Litre
24-BGM-L10	10 Litre



Thread Sealants & Lockers. (Category 24)

BONDLOC Cyanoacrylate Adhesives

B401 is suitable for difficult to bond surfaces. Ideal for porous materials such as rubber, wood, paper, cork and leather. It's low viscosity allows it to be used on close fitting parts.

- Low viscosity
- Good fixture time
- Porous materials



Code	Tube Size
24-B401-003	3g
24-B401-020	20g

B454 gel is suitable for difficult to bond surfaces. Ideal for porous materials such as rubber, wood, paper, cork and leather. Its high viscosity makes it ideal for larger gaps, also vertical and overhead surfaces.

- Porous materials
- Gel



Code	Tube Size
24-B454-020	20g

B406 has a very low viscosity which means it can be used as a wicking grade adhesive for post assembled applications. It is an excellent rubber and plastic bonder and also suitable for difficult to bond materials such as Teflon, polyethylene, polypropylene and silicones.

- Low viscosity - wicking grade
- Rubber and plastic bonder



Code	Tube Size
24-B406-020	20g

B460 is a low odour, low bloom (frosting) adhesive, used where cosmetic appearance is important or vapour irritation is an issue. It has a low viscosity and so is ideal for close fitting parts. A general purpose adhesive, good for bonding metals, plastics, wood, rubber and many other materials.

- Low odour, low bloom
- Good fixture time



Code	Tube Size
24-B460-020	20g

BONDLOC Silicon Sealants



RTV 1,2,3 Silicone is a single component, high modulus acetoxy curing silicone sealant / adhesive that cures at room temperature to provide a permanent flexible seal and bond. Suitable for sealing aluminium and metal fabrications, butt and channel glazing, most industrial applications (gasketing up to 250°C), refrigeration and hygiene seal. Available in Black, Blue, Clear and White.

Code	Pack Size
24-BRTV-080	80ml Tube
24-BRTV-310	310ml Cartridge
Add Colour Suffix to Part Number	

B5180 is a blue coloured, non setting gasket, free from solvent problems of other formulations and stays flexible when cured. Ideal for engine gaskets, cylinder heads, water pumps, gear boxes, threaded assemblies, flanges and pipe joints. The product cures to a non hardening consistency, forming an instant seal that will not crack, chip or flake. Resistant to petrol, steam, mineral and vegetable oils, common solvents and most chemicals.



Code	Pack Size
24-B5180-075	75ml Tube



B5299 Silicone is a high temperature single component, high modulus acetoxy curing silicone sealant / adhesive that cures at room temperature to provide a permanent flexible seal and bond. Suitable for sealing aluminium and metal fabrications, butt and channel glazing, most industrial applications (gasketing up to 350°C), refrigeration and hygiene seal.

Code	Pack Size
24-B5299-310	310ml Cartridge
Add Colour Suffix to Part Number	

B5190 replaces the old conventional, filled products to suit all types of engine surface preparation. Can be used on all types of engine components withstanding temperatures up to +350°C intermittent, +280°C constant. Specific applications include diesel/petrol engines, fuel injectors, pumps, cylinder heads. B5190 can also be used as a threadlocker, securing components, sealing threads etc.

Operating Temperature
-50°C to +350°C



Code	Pack Size
24-B5190-080	80ml Tube

Thread Sealants & Lockers. (Category 24)

BONDLOC Gasketing

B510 is a pink coloured, fast set, form-in-place gasket maker for all types of metal parts, sealing and resisting **temperatures up to 200°C**. Used for sealing any shape or size of high temperature application, dressing gaskets or making rigid assemblies.



Code	Tube Size
24-B510-065	65ml
24-B510-250	250ml

B518 Gasket Seal is a smooth paste. Cures to Form-in-Place a tough, flexible gasket to give an instant low pressure seal. Used for fuel and water pumps, split crank cases, gearbox covers, air compressor end caps etc. B518 can also be used for dressing gaskets.



Code	Tube Size
24-B518-065	65ml

B515 Flange Seal B515 is a purple coloured, smooth, thick paste. Cures to Form-in-Place a tough, flexible gasket to give an instant low pressure seal. Used for fuel and water pumps, split crank cases, gearbox covers, air compressor end caps etc. B515 can also be used for dressing gaskets.



Code	Tube Size
24-B515-065	65ml
24-B515-310	310ml

B573 is a single component, thixotropic anaerobic compound, designed for low strength sealing of large areas and machined surfaces. Allows for easy disassembly and is resistant to most industrial fluids



Code	Tube Size
24-B573-050	50ml

B574 is an instant gasket that forms in place, making almost any size and shape, replacing paper, cork etc. The assembled parts are usually suitable for immediate low pressure (6bar) service and once cured can resist 350bar pressure depending on gap size. Applications include all formed in place applications such as gear box sealing, pump flanges, outer housings and pipe fittings



Code	Tube Size
24-B574-050	50ml

BONDLOC Structural Adhesives



B2001 Metal Epoxy is a hand kneadable epoxy putty that mixes in one minute for permanent repairs to many substrates. May be applied underwater. Bonds to fiberglass, metal, wood, concrete and glass. Hardens in 10 minutes, full strength in 24hours. Ideal for repairing tanks and drums, patching holes in pipes, stopping leaks and repairing porosity holes in castings.

Code	Tube Size
24-B2001-114	114g



B2002 Aluminium Epoxy is a hand kneadable epoxy putty that mixes in one minute for permanent repairs to most aluminium surfaces. The mixed epoxy turns from a silvery colour to "Alloy" upon curing. After final cure, it can be drilled, sawed, tapped, sanded and painted. When applying Aluminium Stick to surfaces it is necessary to work the material forcefully into the surface and apply pressure until adhesion begins to take effect.

Code	Tube Size
24-B2002-114	114g

Thread Sealants & Lockers. (Category 24)

BONDLOC Structural Adhesives /cont)



B2003 Plastic Epoxy is a hand kneadable epoxy putty that mixes in one minute for permanent repairs to most plastic and fibreglass surfaces. The mixed epoxy turns from an aquamarine colour to “fiberglass white” upon curing. After final cure, it can be drilled, sawed, tapped, sanded and painted.

Code	Tube Size
24-B2003-114	114g



B2012 5 Minute Epoxy is a two part, rapid cold curing epoxy adhesive. Suitable for bonding a wide range of surfaces including steel, aluminium and galvanized iron. B2012 reacts within a few minutes to give a tough resilient clear bond.

Code	Tube Size
24-B2012-028	28ml



B2013 Steel Epoxy is a black epoxy putty for general maintenance and repairs. For filling, rebuilding and bonding metal surfaces. Repairs worn and fatigued metals, patching castings, rebuilds pumps and valve bodies.

Code	Tube Size
24-B2013-028	28ml
24-B2013-050	50ml



B2060 60 Second Epoxy is a two part, rapid cold curing epoxy adhesive. Suitable for bonding a wide range of surfaces including steel, aluminium and galvanized iron. B2060 reacts 60 seconds to give a tough resilient clear bond.

Code	Tube Size
24-B2060-028	28ml

BONDLOC Engineers Kit



Packed with 15 different products in a tough reinforced plastic case, this kit has everything for the most demanding engineer. Supplied with full sized bottles the engineers kit is as popular as ever and it remains our top seller. Carefully selected, the range of products provided have proven to be the most frequently used by engineers since Bondloc started manufacturing adhesives nearly 20 years ago.

KIT CONTAINS:

- B222 Screwlock 50ml
- B243 Nutlock x 50ml
- B270 Studlock x 50ml
- B2001 Metal Epoxy Stick x 50g
- B2003 Plastic Epoxy Stick x 50g
- B2060 60 Second Epoxy x 28ml
- B5299 High Temp Gasket x 220ml
- B574 Instant Gasket 50ml
- B577 AGA Pipesal x 50ml
- B401 Instant Adhesive 20g
- B406 Instant Adhesive 20g
- B454 Gel Adhesive x 20g
- B603 Oil Tolerant Retainer 50ml
- B641 Bearing Fit 50ml
- B660 Metal Paste x 50ml

Thread Tape. (Category 24)

White PTFE Thread Tape



Code	Width	Length
24-001	12mm	10M
24-001-30	12mm	30M
24-003	19mm	12M

Working Temperature: -190°C to 232°C. 0.076mm Thick

Pink Plumbers Thread Tape



Code	Width	Length
24-004	12mm	10M
24-004-30	12mm	30M

Working Temperature: -190°C to 232°C. 0.1mm Thick

Yellow Gas Thread Tape



Code	Width	Length
24-007	12mm	10M
24-007-30	12mm	30M
24-008	19mm	10M

AGA Approval N° 6970

Working Temperature: -220°C to 310°C
Working Pressure : 2600KPA — 370PSI
Thickness : 0.1 mm

Stainless Steel Thread Tape



Code	Width	Length
24-013	12mm	6.5M

Thickness : 0.102 mm

Working Temperature : -268°C to 288°C
Working Pressure : 68950KPA — 10000PSI

Denso Tape



Code	Width	Length
24-DENSO050	50mm	10M
24-DENSO075	75mm	10M
24-DENSO100	100mm	10M
24-DENSO150	150mm	10M

Petroleum impregnated tape for the protection of metal surfaces above and below ground.

Green Oxygen Thread Tape



Code	Width	Length
24-010	12mm	12M

Tool and Compressor Oil. (Category 24)

Tool Oil

Our tool oil is 15 grade. Unlike most other tool oils on the market which are 30 grade (Hydraulic Oil), the Fuchs tool oil has a lower viscosity and is ideally suited to air tools.



Code	Size
24-TOIL-0500	500ml
24-TOIL-1000	1 Litre
24-TOIL-5000	5 Litre

Compressor Oil

The compressor oil is 68 grade and is specifically designed to suit both screw and piston type compressors.



Code	Size
24-COIL-1000	1 Litre
24-COIL-5000	5 Litre

IFS Air Equipment. (Category 26)

All products come in Clam Shell Packaging for easy display except the 600 Series

Filter Regulator

Code	Series	Thread	Height	Width
26-GFR200-04	200	1/4 BSP	160mm	47mm
26-GFR300-04	300	1/4 BSP	223mm	60mm
26-GFR300-06	300	3/8 BSP	223mm	60mm
26-GFR300-08	300	1/2 BSP	223mm	60mm
26-GFR400-08	400	1/2 BSP	264mm	80mm
26-GFR600-12	600	3/4 BSP	360mm	99mm
26-GFR600-16	600	1" BSP	360mm	99mm

- Standard filter is 5µ.
- All Filter Regulators come with a bracket and gauge.
- Supplied standard with Semi-Auto drain which drains automatically when system is depressurised. Fully Automatic Drain also available for series 300-600.

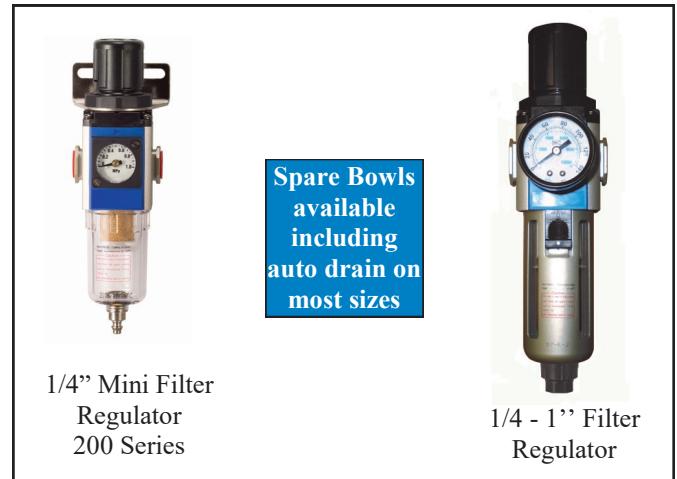

1/4" Mini Filter Regulator
200 Series

1/4 - 1" Filter Regulator

The GFR300-04 is our most common Filter Regulator

Regulator

Code	Series	Thread	Height	Width
26-GR200-04	200	1/4 BSP	90mm	47mm
26-GR300-04	300	1/4 BSP	112mm	60mm
26-GR300-06	300	3/8 BSP	112mm	60mm
26-GR300-08	300	1/2 BSP	112mm	60mm
26-GR400-08	400	1/2 BSP	140mm	80mm
26-GR600-12	600	3/4 BSP	189mm	99mm
26-GR600-16	600	1" BSP	189mm	99mm

All Regulators come with a bracket and gauge.



1/4" Mini Regulator
200 Series

1/4 - 1" Regulator

Filter (Water Trap)

Code	Series	Thread	Height	Width
26-GF200-04	200	1/4 BSP	109mm	47mm
26-GF300-04	300	1/4 BSP	160mm	60mm
26-GF300-06	300	3/8 BSP	160mm	60mm
26-GF300-08	300	1/2 BSP	160mm	60mm
26-GF400-08	400	1/2 BSP	190mm	80mm
26-GF600-12	600	3/4 BSP	225mm	99mm
26-GF600-16	600	1" BSP	225mm	99mm

- Standard filter is 5µ.
- All Filters come with a bracket.
- Supplied standard with Semi-Auto drain which drains automatically when system is depressurised. Fully Automatic Drain also available for series 300-600.

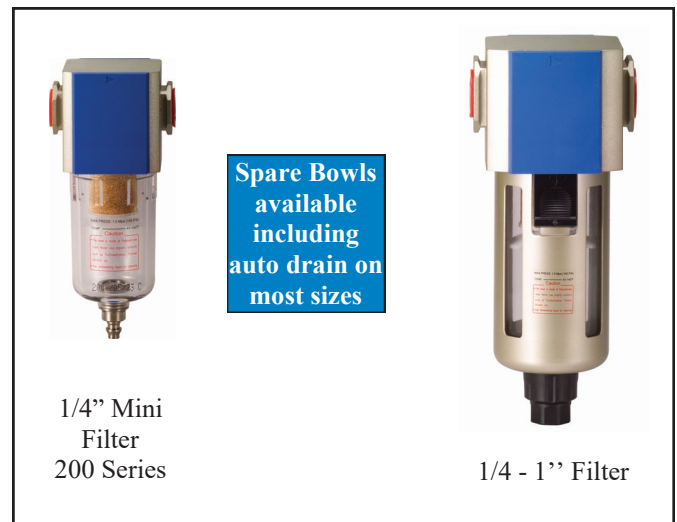

1/4" Mini Filter
200 Series

1/4 - 1" Filter

Port Size	200 Mini Series 1/4"	300 Series 1/4, 3/8 & 1/2	400 Series 1/2"	600 Series 3/4 & 1"
Max Working Pressure	145psi	145psi	145psi	145psi
Maximum Flow Rate	3000 l/min	4000 l/min	6000 l/min	12000 l/min
Working Temperature	-10°C to +60°C	-10°C to +60°C	-10°C to +60°C	-10°C to +60°C

IFS Air Equipment. (Category 26)

Lubricator

Code	Series	Thread	Height	Width
26-GL200-04	200	1/4 BSP	119mm	47mm
26-GL300-04	300	1/4 BSP	168mm	60mm
26-GL300-06	300	3/8 BSP	168mm	60mm
26-GL300-08	300	1/2 BSP	168mm	60mm
26-GL400-08	400	1/2 BSP	187mm	80mm
26-GL600-12	600	3/4 BSP	256mm	99mm
26-GL600-16	600	1" BSP	256mm	99mm

All Lubricators come with a bracket.
Lubricator can be refilled without shutting down the system.

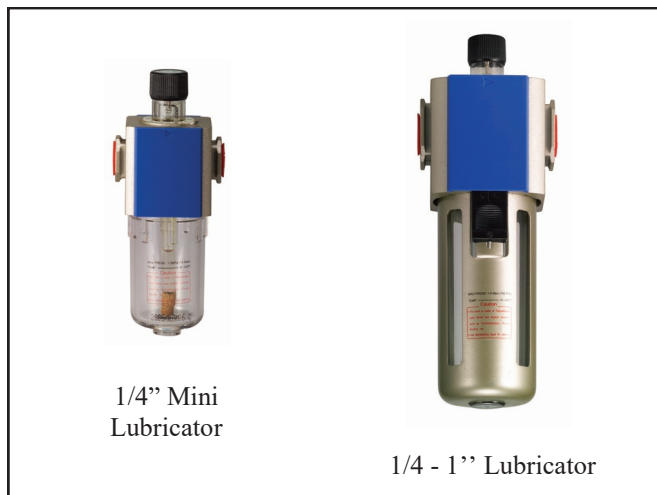

1/4" Mini Lubricator

1/4 - 1" Lubricator

Filter Regulator + Lubricator

Code	Series	Thread	Height	Width
26-GMA200-04	200	1/4 BSP	160mm	99mm
26-GMA300-04	300	1/4 BSP	223mm	126mm
26-GMA300-06	300	3/8 BSP	223mm	126mm
26-GMA300-08	300	1/2 BSP	264mm	126mm
26-GMA400-08	400	1/2 BSP	360mm	169mm

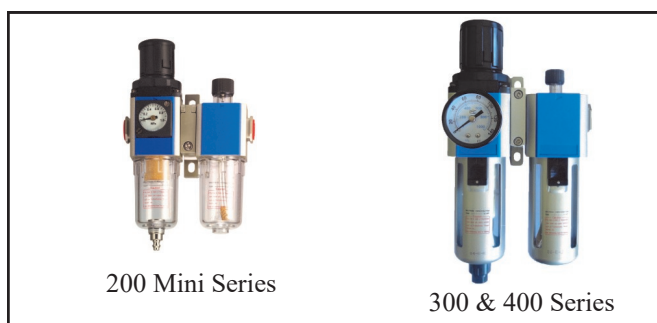

200 Mini Series

300 & 400 Series

Filter + Regulator + Lubricator

Code	Series	Thread	Height	Width
26-GMB200-04	200	1/4 BSP	139mm	151mm
26-GMB300-04	300	1/4 BSP	188mm	192mm
26-GMB300-06	300	3/8 BSP	188mm	192mm
26-GMB300-08	300	1/2 BSP	188mm	192mm
26-GMB400-08	400	1/2 BSP	207mm	258mm

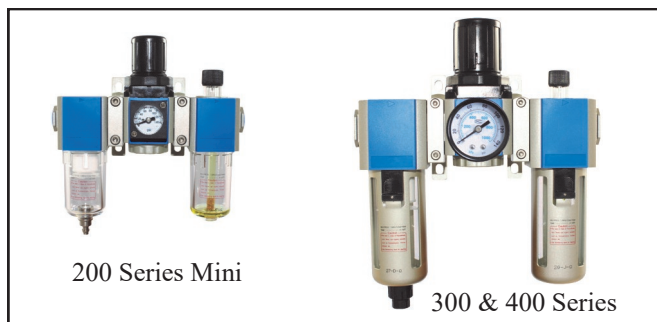

200 Series Mini

300 & 400 Series

Distribution Blocks

Positioned between the Filter Reg and Lubricator with a joining or mounting bracket, air can be distributed to separate locations.

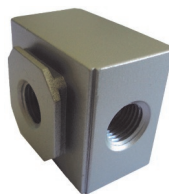

Code	Description
26-GA214-04	200 Series Distribution Block 1/4 Outlet
26-GA314-04	300 Series Distribution Block 1/4 Outlet
26-GA414-08	400 Series Distribution Block 1/2 Outlet
26-GA614-16	600 Series Distribution Block 1" Outlet

Mounting Brackets

Code	Description
26-GA201	200 Series Mounting Bracket
26-GA301	300 Series Mounting Bracket
26-GA401	400 Series Mounting Bracket

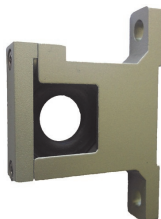

Used to join units together. Supplied with mounting holes.

Joining Brackets

Code	Description
26-GA203	200 Series Joining Bracket
26-GA303	300 Series Joining Bracket
26-GA403	400 Series Joining Bracket



Used to join units together.

SEE NEXT PAGE FOR SPARE BOWLS AND FILTER ELEMENTS

IFS Air Equipment. (Category 26)

Auto Drain Filter Bowls

Code	Description
26-ADB300	300 Series Auto Drain Bowl
26-ADB400	400 Series Auto Drain Bowl
26-ADB600	600 Series Auto Drain Bowl



Replacement Bowls and Filter Elements

Series	Bowl Code	Element Code
200	26-GB200	26-GFE200
300	26-GB300	26-GFE300
400	26-GB400	26-GFE400
600	26-GB600	26-GFE600

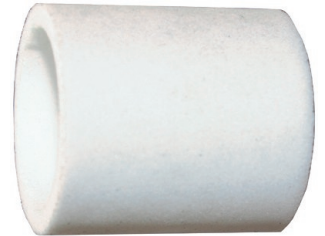

Drop Leg Auto-Drain

Code	Size
26-AADS-08	1/2" Inlet, 3/8" Outlet

Used at the bottom of air line drop legs to automatically drain water and oil build up in compressed air systems.



Lockout Valve

Code	Description
26-GZ300-04	300 Series 1/4 Port
26-GZ300-08	300 Series 1/2 Port
26-GZ400-08	400 Series 1/2 Port

Shuts off the air supply to purge the down stream line. Allows safe maintenance on the air system.

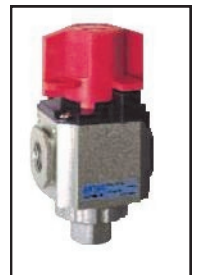

Digital In-Line Regulator

- Large LCD display
- Regulating Range: 0-150psi
- Accuracy: +/- 2%
- Port Size: 1/4 BSP Male x Female
- Air Flow: 2.31cfm at 100psi
- Battery Life: 1500hrs continuous use
- Ideal for spray guns

Code : 26-DAR04



1/4 M&F Mini In-Line Flow Control



Twist the sleeve to regulate flow

Code : 26-AFC04

1/4 M&F Mini In-Line Filter



Code : 26-AFM04

1/4 M&F Mini In-Line Oiler

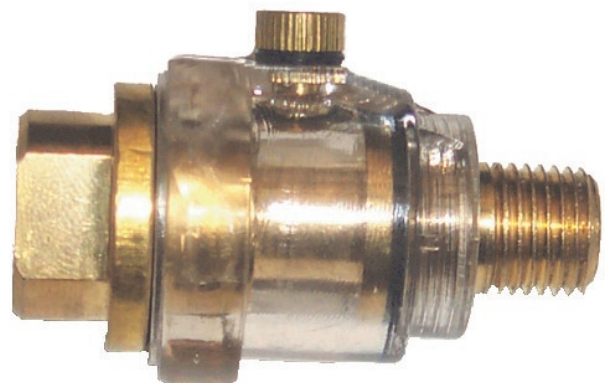

Code : 26-ALM04

Speed Controllers. (Category 26)



SE
Banjo Elbow
Speed Controller

Code	Tube	Male
26-SE0402	1/4	1/8 BSPT
26-SE0404	1/4	1/4 BSPT
26-SE0604	3/8	1/4 BSPT
26-SE0606	3/8	3/8 BSPT
26-SE0608	3/8	1/2 BSPT
26-SEM0402	4mm	1/8 BSPT
26-SEM04M05	4mm	M5x0.8
26-SEM0602	6mm	1/8 BSPT
26-SEM0604	6mm	1/4 BSPT
26-SEM0606	6mm	3/8 BSPT
26-SEM06M05	6mm	M5x0.8
26-SEM06P02	6mm	1/8 BSPP
26-SEM06P04	6mm	1/4 BSPP
26-SEM0802	8mm	1/8 BSPT
26-SEM0804	8mm	1/4 BSPT
26-SEM0806	8mm	3/8 BSPT
26-SEM0808	8mm	1/2 BSPT
26-SEM08P02	8mm	1/8 BSPP
26-SEM08P04	8mm	1/4 BSPP
26-SEM08P06	8mm	3/8 BSPP
26-SEM1004	10mm	1/4 BSPT
26-SEM1006	10mm	3/8 BSPT
26-SEM1008	10mm	1/2 BSPT
26-SEM1204	12mm	1/4 BSPT
26-SEM1206	12mm	3/8 BSPT
26-SEM1208	12mm	1/2 BSPT



SS
Vertical Elbow
Speed Controller

Code	Tube	Male
26-SSM0402	4mm	1/8 BSPT
26-SSM0404	4mm	1/4 BSPT
26-SSM0602	6mm	1/8 BSPT
26-SSM0604	6mm	1/4 BSPT
26-SSM0802	8mm	1/8 BSPT
26-SSM0804	8mm	1/4 BSPT

SE and SS style speed controllers are meter out (cylinder exhaust) versions with free flow back towards the threaded end.

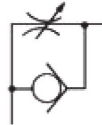

When a pneumatic cylinder chamber is filled with pressurized air and the air chamber on the other side of the piston is metered out by a flow control, the movement or speed of the cylinder is more consistent than to meter in the pressurized air.

Please contact the sales office if you require the meter in version.



SI
In-Line
Speed Controller

Code	Tube
26-SI03	3/16
26-SI04	1/4
26-SI06	3/8
26-SI08	1/2
26-SIM04	4mm
26-SIM06	6mm
26-SIM08	8mm
26-SIM10	10mm
26-SIM12	12mm



SF
Female In-Line
Flow Controller

Code	Female
26-SF02	1/8 BSP
26-SF04	1/4 BSP
26-SF06	3/8 BSP
26-SF08	1/2 BSP

Shut-Off Valves (Hand Taps.) (Category 26)



Male x Male
Hand Tap

Code	Male
26-HM0202	1/8 BSPT
26-HM0404	1/4 BSPT
26-HM0606	3/8 BSPT
26-HM0808	1/2 BSPT



Tube x Tube
Hand Tap

Code	Tube
26-HT0606	6mm
26-HT0808	8mm
26-HT1010	10mm
26-HT1212	12mm



Male x Tube
Hand Tap

Code	Male	Tube
26-HMT0602	1/8 BSPT	6mm
26-HMT0604	1/4 BSPT	6mm
26-HMT0804	1/4 BSPT	8mm
26-HMT1004	1/4 BSPT	10mm
26-HMT1006	3/8 BSPT	10mm
26-HMT1204	1/4 BSPT	12mm
26-HMT1208	1/2 BSPT	12mm
Vents on tube side of Valve		



Tube x Male
Hand Tap

Code	Tube	Male
26-HTM0602	6mm	1/8 BSPT
26-HTM0604	6mm	1/4 BSPT
26-HTM0606	6mm	3/8 BSPT
26-HTM0802	8mm	1/8 BSPT
26-HTM0804	8mm	1/4 BSPT
26-HTM0806	8mm	3/8 BSPT
26-HTM1004	10mm	1/4 BSPT
26-HTM1006	10mm	3/8 BSPT
26-HTM1008	10mm	1/2 BSPT
26-HTM1204	12mm	1/4 BSPT
26-HTM1206	12mm	3/8 BSPT
26-HTM1208	12mm	1/2 BSPT
Vents on threaded side of Valve		

Used for turning air pressure on and off to pneumatic devices. When the air supply is closed, the three-way control valve prevents incoming air and discharges residual air on the output side, enabling safe maintenance of downstream components.

Clippard Miniature Control Valves. (Category 26)



3 Port
Toggle
Valve

Code : 26-MJTV-3

SPECIFICATIONS

Type: Normally **closed** 3-way poppet, 2 position toggle valve
 Medium: Air, water or oil
 In pressure: 300psi max
 Air Flow: @50psi = 14 SCFM @ 100psi = 25 SCFM
 Temp Range: 0° C—100° C
 Ports: Inlet, outlet and exhaust are all 1/8NPT
 Mounting: 15/32-32 male threads. Nuts and washers supplied



5 Port
Toggle
Valve

Code : 26-MJTV-5

SPECIFICATIONS

Type: 4-way spool valve toggle actuated 2 position toggle valve
 Medium: Air water, oil.
 In Pressure: 150 psi max
 Air Flow: @50 psi = 6.5 SCFM @100 psi = 10.5 SCFM
 Temp: 0°c - 100°c
 Ports: All ports are 1/8NPT
 Mounting: 15/32-32 male threads. Nuts and washers supplied

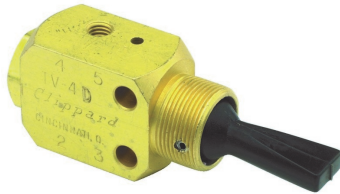

Code : 26-TV-4DP

SPECIFICATIONS

Type : 3-Position, 4-Way Valve, Plastic Toggle
 Air Flow : 7.5 scfm@100 psig
 Force : 3.0 oz nominal
 Max PSI : 120 psig
 Ports 1/8 : NPT
 Temperature Range : 32 to 230 F
 Travel Arc : 30 degrees each side of centre

Many other Clippard valves also available. Contact the sales office with your requirements.



Compressor Filters. (Category 26)

Code	Style	Thread Size	Diameter	Material	Element Code	Element Type	Element Size
26-CF06	C	3/8 BSP	65mm	Plastic	N/A	Foam	
26-CF08	A	1/2 BSP	90mm	Plastic	26-CFE08	Paper	67x35x35mm
26-CF12	A	3/4 BSP	135mm	Plastic	26-CFE12	Paper	67x35x67mm
26-CF16	B	1" BSP	150mm	Plastic	26-CFE16	Paper	105x70x50mm

Note : 26-CF12 has a metal thread. All other sizes have plastic thread.



Rectangular Filter Assembly

Code 26-CFS

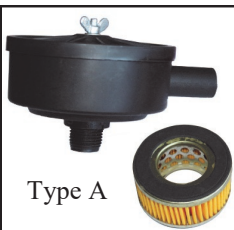

Type A

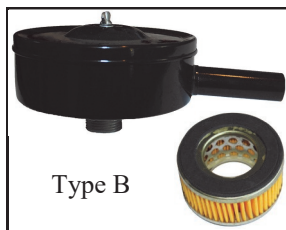

Type B



Type C

Do you need a thread sealant? We stock various types of thread tape and a full range of Bondloc thread lockers and sealants.



BONDLOC[®]
FORMULAS THAT WORK



Air Manifolds. (Category 26)

Type S1

Silver anodised aluminium. Single Sided with Mounting Holes (4 ports = 4 outlets on one side)

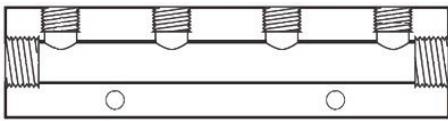

Code	Inlet	Outlet	Ports
26-MAS0402-4	1/4 BSP	1/8 BSP	4
26-MAS0402-5	1/4 BSP	1/8 BSP	5
26-MAS0402-6	1/4 BSP	1/8 BSP	6
26-MAS0604-3	3/8 BSP	1/4 BSP	3
26-MAS0604-4	3/8 BSP	1/4 BSP	4
26-MAS0604-5	3/8 BSP	1/4 BSP	5
26-MAS0604-6	3/8 BSP	1/4 BSP	6



Type S2

Blue anodised aluminium. Single Sided. No Mounting Holes. Has 1 extra port in the back.

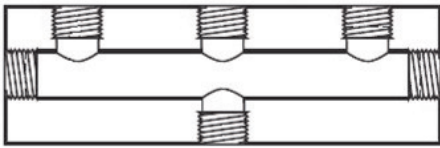

Code	Inlet	Outlet	Ports
26-MAS0404-2	1/4 BSP	1/4 BSP	2
26-MAS0404-3	1/4 BSP	1/4 BSP	3
26-MAS0404-4	1/4 BSP	1/4 BSP	4
26-MAS0404-5	1/4 BSP	1/4 BSP	5



Type D

Silver anodised aluminium. Double Sided with Mounting Holes (6 ports = 3 outlets each side)

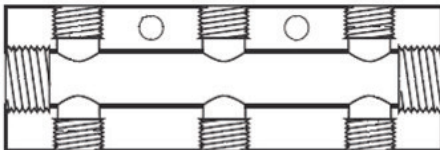

Code	Inlet	Outlet	Ports
26-MAD0402-8	1/4 BSP	1/8 BSP	8
26-MAD0604-6	3/8 BSP	1/4 BSP	6
26-MAD0604-8	3/8 BSP	1/4 BSP	8



Type M

Silver anodised aluminium. Mushroom shape.

Code	Inlet	Outlet	Ports
26-MAM0404-3	1/4 BSP	1/4 BSP	3

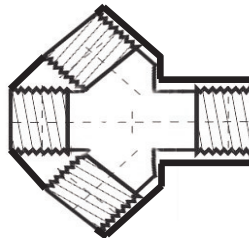

Type S3

Nickel Plated Brass. Single Sided. Female Outlets. One Male Inlet and 1 Female

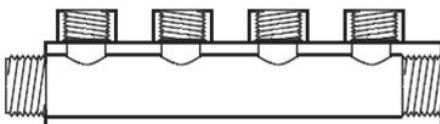

Code	Inlet	Outlet	Ports
26-MBS1208-4	3/4 BSP	1/2 BSP	4



Type S4

Nickel Plated Brass. Single Sided. Male Outlets. One Male Inlet and 1 Female

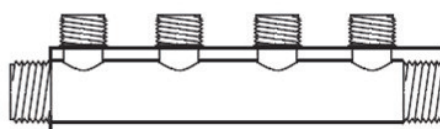

Code	Inlet	Outlet	Ports
26-MBS1208-4M	3/4 BSP	1/2 BSP	4



Air Silencers. (Category 26)



SF
Flat Silencer

Code	Male
26-ASF02	1/8 BSPP
26-ASF04	1/4 BSPP
26-ASF06	3/8 BSPP
26-ASF08	1/2 BSPP
26-ASF12	3/4 BSPP
26-ASF16	1" BSPP
26-ASFM05	M5x0.8



SPL
Legris Style
Plastic Silencer

Code	Male
26-ASPL02	1/8 BSPP
26-ASPL04	1/4 BSPP
26-ASPL06	3/8 BSPP
26-ASPL08	1/2 BSPP
26-ASPL12	3/4 BSPP
26-ASPL16	1" BSPP

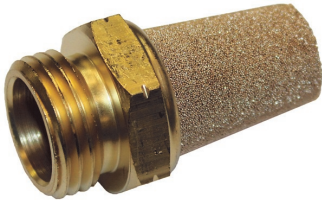

SM
Medium Silencer

Code	Male
26-ASM02	1/8 BSPP
26-ASM04	1/4 BSPP
26-ASM06	3/8 BSPP
26-ASM08	1/2 BSPP
26-ASM12	3/4 BSPP
26-ASM16	1" BSPP
26-ASMM05	M5x0.8

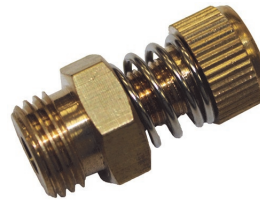

SVE
Regulated
Silencer

Code	Male
26-ASVE02	1/8 BSPP
26-ASVE04	1/4 BSPP



SVL
Regulated
Silencer with Locknut

Code	Male
26-ASVL02	1/8 BSPP
26-ASVL04	1/4 BSPP
26-ASVL06	3/8 BSPP

SF and SM silencers also available in Stainless Steel. Refer Category 31



SP
Plastic
Silencer

Code	Male
26-ASP02	1/8 BSPP
26-ASP04	1/4 BSPP
26-ASP06	3/8 BSPP
26-ASP08	1/2 BSPP



RB
Domed Air
Breather / Filter

Code	Male
26-RB04	1/4 BSPT
26-RB06	3/8 BSPT
26-RB08	1/2 BSPT
26-RB12	3/4 BSPT

Brass Breathers also available. Refer to Screwed Brass Section

Do you need a thread sealant? We stock various types of thread tape and a full range of Bondloc thread lockers and sealants.

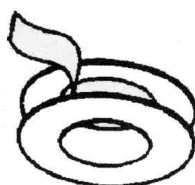

Pressure & Vacuum Gauges (Category 27)

PART NUMBERING SYSTEM

27- [] [] [] [] [] - []

- Pressure	- Dry	04 - 40mm face	B - Bottom Entry	2 - 1/8 BSP
C - Compound	L - Liquid Filled	05 - 50mm face	R - Rear Entry	4 - 1/4 BSP
S - All Stainless		06 - 63mm face		6 - 3/8 BSP
V - Vacuum		08 - 80mm face		8 - 1/2 BSP
		10 - 100mm face		

001 - 100 kpa / 15 psi
002 - 250 kpa / 36 psi
004 - 400 kpa / 58 psi
006 - 600 kpa / 87 psi
007 - 700 kpa / 100 psi
008 - 800 kpa / 116 psi
010 - 1000 kpa / 145 psi
014 - 1400 kpa / 200 psi
016 - 1600 kpa / 230 psi
025 - 2500 kpa / 360 psi
040 - 4000 kpa / 580 psi
060 - 6000 kpa / 870 psi
070 - 7000 kpa / 1000 psi
080 - 8000 kpa / 1160 psi
100 - 10000 kpa / 1450 psi
160 - 16000 kpa / 2320 psi
207 - 20700 kpa / 3000 psi
250 - 25000 kpa / 3600 psi
400 - 40000 kpa / 5800 psi
600 - 60000 kpa / 8700 psi

CE Certificate of compliance. 10/CN/2226-0-REV 0

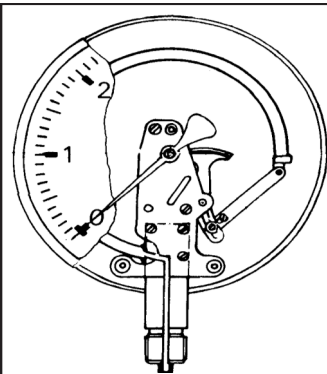

- All Gauges are Bourdon Tube Type
- Bourdon Tube Gauges are suited to most general equipment applications
- Liquid filling protects the internals of a gauge from corrosive atmospheres and dampens the effect of vibration and pulsation
- To prevent damage, gauges should not be used at more than 2/3 of their maximum readout.



Case & Bezel - 304 Stainless Steel or Black Steel

Face Material - Glass for dry gauges 40mm, 50mm, 63mm and 100mm. Polycarbonate for liquid filled gauges and 80mm dry gauges. Safety Glass for all stainless gauges

Working Temperature: -20 to +60° C

OEM gauges available with custom dial and company name.

40mm Dry Gauges. Brass Internals



BOTTOM ENTRY			
Code	Range	Case	Thread
27-04B2-002	0-250 kpa / 36 psi	Stainless Steel	1/8 BSPT
27-04B2-004	0-400 kpa / 58 psi	Stainless Steel	1/8 BSPT
27-04B2-010	0-1000 kpa / 145 psi	Stainless Steel	1/8 BSPT

REAR ENTRY			
Code	Range	Case	Thread
27-V04R2-001	-100 - 0 kpa	Stainless Steel	1/8 BSPT
27-04R2-002	0-250 kpa / 36 psi	Stainless Steel	1/8 BSPT
27-04R2-004	0-400 kpa / 58 psi	Stainless Steel	1/8 BSPT
27-04R2-010	0-1000 kpa / 145 psi	Stainless Steel	1/8 BSPT
27-04R4-010	0-1000 kpa / 145 psi	Stainless Steel	1/4 BSPT

Pressure & Vacuum Gauges (Category 27)

50mm Dry Gauges. Brass Internals



BOTTOM ENTRY			
Code	Range	Case	Thread
27-V05B4-001	-100 - 0 kpa	Stainless Steel	1/4 BSPT
27-05B2-008B	0-800 kpa / 116 psi	Black Steel	1/8 BSPT
27-05B4-001	0-100 kpa / 15 psi	Stainless Steel	1/4 BSPT
27-05B4-0016	0-160 kpa / 23 psi	Stainless Steel	1/4 BSPT
27-05B4-002	0-250 kpa / 36 psi	Stainless Steel	1/4 BSPT
27-05B4-002FC	0-250 kpa / 36 psi	SS Filter Clean	1/4 BSPT
27-05B4-004	0-400 kpa / 58 psi	Stainless Steel	1/4 BSPT
27-05B4-004BS	0-400 kpa / 58 psi	Black Safety	1/4 BSPT
27-05B4-008	0-800 kpa / 116 psi	Stainless Steel	1/4 BSPT
27-05B4-008B	0-800 kpa / 116 psi	Black Steel	1/4 BSPT
27-05B4-010	0-1000 kpa / 145 psi	Stainless Steel	1/4 BSPT
27-05B4-010B	0-1000 kpa / 145 psi	Black Steel	1/4 BSPT
27-05B4-016	0-1600 kpa / 230 psi	Stainless Steel	1/4 BSPT
27-05B4-016B	0-1600 kpa / 230 psi	Black Steel	1/4 BSPT
27-05B4-025	0-2500 kpa / 360 psi	Stainless Steel	1/4 BSPT
27-05B4-040	0-4000 kpa / 580 psi	Stainless Steel	1/4 BSPT
27-05B4-080BS	0-8000 kpa / 1160 psi	Black Safety	1/4 BSPT
27-05B4-160	0-16000 kpa / 2320 psi	Stainless Steel	1/4 BSPT
27-05B4-160BS	0-16000 kpa / 2320 psi	Black Safety	1/4 BSPT
27-05B4-250BS	0-25000 kpa / 3600 psi	Black Safety	1/4 BSPT
27-05B4N-025	0-2500 kpa / 360 psi	Stainless Steel	1/4 NPT



REAR ENTRY			
Code	Range	Case	Thread
27-V05R2-001	-100 - 0 kpa	Stainless Steel	1/8 BSPT
27-05R2-002	0-250 kpa / 36 psi	Stainless Steel	1/8 BSPT
27-05R2-004	0-400 kpa / 58 psi	Stainless Steel	1/8 BSPT
27-05R2-008	0-800 kpa / 116 psi	Stainless Steel	1/8 BSPT
27-05R2-010	0-1000 kpa / 145 psi	Stainless Steel	1/8 BSPT
27-05R2-010B	0-1000 kpa / 145 psi	Black Steel	1/8 BSPT
27-05R2-016	0-1600 kpa / 230 psi	Stainless Steel	1/8 BSPT
27-05R2-040	0-4000 kpa / 580 psi	Stainless Steel	1/8 BSPT
27-05R4-001	0-100 kpa / 15 psi	Stainless Steel	1/4 BSPT
27-05R4-002	0-250 kpa / 36 psi	Stainless Steel	1/4 BSPT
27-05R4-002FC	0-250 kpa / 36 psi	SS Filter Clean	1/4 BSPT
27-05R4-008	0-800 kpa / 116 psi	Stainless Steel	1/4 BSPT
27-05R4-010	0-1000 kpa / 145 psi	Stainless Steel	1/4 BSPT
27-05R4-016	0-1600 kpa / 230 psi	Stainless Steel	1/4 BSPT
27-05R4-016B	0-1600 kpa / 230 psi	Black Steel	1/4 BSPT

Panel Mount Kits to Suit 40 and 50mm rear entry gauges

Code	Gauge size
27-PMK04	40mm
27-PMK05	50mm



Pressure & Vacuum Gauges (Category 27)

63mm Dry Gauges. Brass Internals



BOTTOM ENTRY			
Code	Range	Case	Thread
27-V06B4-001	-100 - 0 kpa	Stainless Steel	1/4 BSPT
27-06B4-001	0-100 kpa / 15 psi	Stainless Steel	1/4 BSPT
27-06B4-002	0-250 kpa / 36 psi	Stainless Steel	1/4 BSPT
27-06B4-004	0-400 kpa / 58 psi	Stainless Steel	1/4 BSPT
27-06B4-006	0-600 kpa / 87 psi	Stainless Steel	1/4 BSPT
27-06B4-008	0-800 kpa / 116 psi	Stainless Steel	1/4 BSPT
27-06B4-010	0-1000 kpa / 145 psi	Stainless Steel	1/4 BSPT
27-06B4-016	0-1600 kpa / 230 psi	Stainless Steel	1/4 BSPT
27-06B4-025	0-2500 kpa / 360 psi	Stainless Steel	1/4 BSPT
27-06B4-040	0-4000 kpa / 580 psi	Stainless Steel	1/4 BSPT
27-06B4-040B	0-4000 kpa / 580 psi	Black Steel	1/4 BSPT
27-06B4-060	0-6000 kpa / 870 psi	Stainless Steel	1/4 BSPT



REAR ENTRY			
Code	Range	Case	Thread
27-06R4-002	0-250 kpa / 36 psi	Stainless Steel	1/4 BSPT
27-06R4-010	0-1000 kpa / 145 psi	Stainless Steel	1/4 BSPT
27-06R4-016	0-1600 kpa / 230 psi	Stainless Steel	1/4 BSPT
27-06R4-040	0-4000 kpa / 580 psi	Stainless Steel	1/4 BSPT

Panel Mount Kit to Suit 63mm rear entry gauges



Code : 27-PMK06



Front Flange to Suit 50 and 63mm rear entry gauges

Code	Gauge size
27-FF05	50mm
27-FF06	63mm



Pressure & Vacuum Gauges (Category 27)

63mm Rubber Gauge Protector

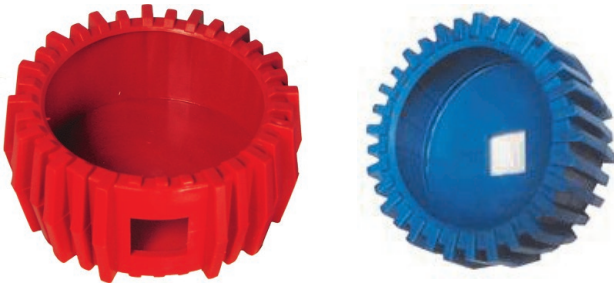

Code	Description
27-06B4-RP	63mm 1/4 Bottom Entry Rubber Gauge Protector
27-06R4-RP	63mm 1/4 Rear Entry Rubber Gauge Protector

- Fits both dry and liquid filled 63mm gauges

80mm Dry Gauges. Brass Internals



BOTTOM ENTRY			
Code	Range	Case	Thread
27-08B4-002B	0-250 kpa	Black Steel	1/4 BSPT
27-08B4-004B	0-400 kpa	Black Steel	1/4 BSPT
27-08B4-008B	0-800 kpa	Black Steel	1/4 BSPT
27-08B4-010B	0-1000 kpa	Black Steel	1/4 BSPT
27-08B4-016B	0-1600 kpa	Black Steel	1/4 BSPT
27-08B4-025B	0-2500 kpa	Black Steel	1/4 BSPT
27-08B4-040B	0-4000 kpa	Black Steel	1/4 BSPT



REAR ENTRY			
Code	Range	Case	Thread
27-08R4-016B	0-1600 kpa	Black Steel	1/4 BSPT
27-08R4-025B	0-2500 kpa	Black Steel	1/4 BSPT

100mm Dry Gauges. Brass Internals



BOTTOM ENTRY			
Code	Range	Case	Thread
27-V10B6-001	-100 - 0 kpa	Stainless Steel	3/8 BSPT
27-10B6-001	0-100 kpa / 15 psi	Stainless Steel	3/8 BSPT
27-10B6-002	0-250 kpa / 36 psi	Stainless Steel	3/8 BSPT
27-10B6-004	0-400 kpa / 58 psi	Stainless Steel	3/8 BSPT
27-10B6-008	0-800 kpa / 116 psi	Stainless Steel	3/8 BSPT
27-10B6-008B	0-800 kpa / 116 psi	Black Steel	3/8 BSPT
27-10B6-010	0-1000 kpa / 145 psi	Stainless Steel	3/8 BSPT
27-10B6-016	0-1600 kpa / 230 psi	Stainless Steel	3/8 BSPT
27-10B6-025	0-2500 kpa / 360 psi	Stainless Steel	3/8 BSPT
27-10B6-040	0-4000 kpa / 580 psi	Stainless Steel	3/8 BSPT

Pressure & Vacuum Gauges (Category 27)

63mm Liquid Filled Gauges. Brass Internals



BOTTOM ENTRY			
Code	Range	Case	Thread
27-VL06B4-001	-100 - 0 kpa	Stainless Steel	1/4 BSPT
27-CL06B4-001	-100 - 100 kpa	Stainless Steel	1/4 BSPT
27-L06B4-001	0-100 kpa / 15 psi	Stainless Steel	1/4 BSPT
27-L06B4-002	0-250 kpa / 36 psi	Stainless Steel	1/4 BSPT
27-L06B4-004	0-400 kpa / 58 psi	Stainless Steel	1/4 BSPT
27-L06B4-006	0-600 kpa / 87 psi	Stainless Steel	1/4 BSPT
27-L06B4-007	0-700 kpa / 100 psi	Stainless Steel	1/4 BSPT
27-L06B4-008	0-800 kpa / 116 psi	Stainless Steel	1/4 BSPT
27-L06B4-010	0-1000 kpa / 145 psi	Stainless Steel	1/4 BSPT
27-L06B4-014	0-1400 kpa / 200 psi	Stainless Steel	1/4 BSPT
27-L06B4-016	0-1600 kpa / 230 psi	Stainless Steel	1/4 BSPT
27-L06B4-025	0-2500 kpa / 360 psi	Stainless Steel	1/4 BSPT
27-L06B4-040	0-4000 kpa / 580 psi	Stainless Steel	1/4 BSPT
27-L06B4-060	0-6000 kpa / 870 psi	Stainless Steel	1/4 BSPT
27-L06B4-070	0-7000 kpa / 1000 psi	Stainless Steel	1/4 BSPT
27-L06B4-080	0-8000 kpa / 1160 psi	Stainless Steel	1/4 BSPT
27-L06B4-100	0-10000 kpa / 1450 psi	Stainless Steel	1/4 BSPT
27-L06B4-160	0-16000 kpa / 2320 psi	Stainless Steel	1/4 BSPT
27-L06B4-207	0-20700 kpa / 3000 psi	Stainless Steel	1/4 BSPT
27-L06B4-250	0-25000 kpa / 3600 psi	Stainless Steel	1/4 BSPT
27-L06B4-400	0-40000 kpa / 5800 psi	Stainless Steel	1/4 BSPT
27-L06B4-600	0-60000 kpa / 8700 psi	Stainless Steel	1/4 BSPT
27-L06B4-690	0-69000 kpa / 10000 psi	Stainless Steel	1/4 BSPT
27-L06B4P-016	0-16 Bar / 230 psi	Stainless Steel	1/4 BSPP



REAR ENTRY			
Code	Range	Case	Thread
27-VL06R4-001	-100 - 0 kpa	Stainless Steel	1/4 BSPT
27-L06R4-001	0-100 kpa / 15 psi	Stainless Steel	1/4 BSPT
27-L06R4-002	0-250 kpa / 36 psi	Stainless Steel	1/4 BSPT
27-L06R4-004	0-400 kpa / 58 psi	Stainless Steel	1/4 BSPT
27-L06R4-006	0-600 kpa / 87 psi	Stainless Steel	1/4 BSPT
27-L06R4-008	0-800 kpa / 116 psi	Stainless Steel	1/4 BSPT
27-L06R4-010	0-1000 kpa / 145 psi	Stainless Steel	1/4 BSPT
27-L06R4-016	0-1600 kpa / 230 psi	Stainless Steel	1/4 BSPT
27-L06R4-025	0-2500 kpa / 360 psi	Stainless Steel	1/4 BSPT
27-L06R4-040	0-4000 kpa / 580 psi	Stainless Steel	1/4 BSPT
27-L06R4-060	0-6000 kpa / 870 psi	Stainless Steel	1/4 BSPT
27-L06R4-080	0-8000 kpa / 1160 psi	Stainless Steel	1/4 BSPT
27-L06R4-160	0-16000 kpa / 2320 psi	Stainless Steel	1/4 BSPT
27-L06R4-250	0-25000 kpa / 3600 psi	Stainless Steel	1/4 BSPT
27-L06R4-400	0-40000 kpa / 5800 psi	Stainless Steel	1/4 BSPT

Please Note: Liquid filled gauges must be vented (after installation)
 This is to prevent build-up of pressure if gauge leaks internally.
 Liquid filled gauges are not suitable where oxidising agents such as
 Oxygen, Chlorine, Nitric Acid and Hydrogen Peroxide are being used

Pressure & Vacuum Gauges (Category 27)

100mm Liquid Filled Gauges. Brass Internals



BOTTOM ENTRY			
Code	Range	Case	Thread
27-CL10B6-0015	-100 - 150 kpa	Stainless Steel	3/8 BSPT
27-L10B6-002	0-250 kpa / 36 psi	Stainless Steel	3/8 BSPT
27-L10B6-004	0-400 kpa / 58 psi	Stainless Steel	3/8 BSPT
27-L10B6-008	0-800 kpa / 116 psi	Stainless Steel	3/8 BSPT
27-L10B6-010	0-1000 kpa / 145 psi	Stainless Steel	3/8 BSPT
27-L10B6-016	0-1600 kpa / 230 psi	Stainless Steel	3/8 BSPT
27-L10B6-025	0-2500 kpa / 360 psi	Stainless Steel	3/8 BSPT
27-L10B6-040	0-4000 kpa / 580 psi	Stainless Steel	3/8 BSPT
27-L10B6-060	0-6000 kpa / 870 psi	Stainless Steel	3/8 BSPT
27-L10B6-080	0-8000 kpa / 1160 psi	Stainless Steel	3/8 BSPT
27-L10B6-100	0-10000 kpa / 1450 psi	Stainless Steel	3/8 BSPT
27-L10B6-160	0-16000 kpa / 2320 psi	Stainless Steel	3/8 BSPT
27-L10B6-250	0-25000 kpa / 3600 psi	Stainless Steel	3/8 BSPT
27-L10B6-400	0-40000 kpa / 5800 psi	Stainless Steel	3/8 BSPT

REAR ENTRY			
Code	Range	Case	Thread
27-L10R6-008	0-800 kpa / 116 psi	Stainless Steel	3/8 BSPT
27-L10R6-010	0-1000 kpa / 145 psi	Stainless Steel	3/8 BSPT
27-L10R6-016	0-1600 kpa / 230 psi	Stainless Steel	3/8 BSPT
27-L10R6-025	0-2500 kpa / 360 psi	Stainless Steel	3/8 BSPT
27-L10R6-040	0-4000 kpa / 580 psi	Stainless Steel	3/8 BSPT

63mm Full Stainless Steel Liquid Filled Gauges

BOTTOM ENTRY		
Code	Range	Thread
27-SL06B4-008	0-800 kpa / 116 psi	1/4 BSPT
27-SL06B4-010	0-1000 kpa / 145 psi	1/4 BSPT
27-SL06B4-016	0-1600 kpa / 230 psi	1/4 BSPT
27-SL06B4-025	0-2500 kpa / 360 psi	1/4 BSPT
27-SL06B4-040	0-4000 kpa / 580 psi	1/4 BSPT
27-SL06B4N-010	0-1000 kpa / 145 psi	1/4 NPT
27-SL06B4N-016	0-1600 kpa / 230 psi	1/4 NPT
27-SL06B4N-080	0-8000 kpa / 1160 psi	1/4 NPT



Pressure Gauge Snubber

Code	Male	Female	Material
27-SN04MF	1/4 BSPT	1/4 BSP	Stainless Steel



Gauge snubbers are used to minimize effects from pulsation and surges. The snubber helps keep accurate data flowing by dampening pulsation and surges, increasing gauge life by reducing wear.

Brass Twin Ferrule Compression Fittings (Category 29)



**#1B
Ferrule Set**

Code	Tube
29-B001-02	1/8
29-B001-03	3/16
29-B001-04	1/4
29-B001-05	5/16
29-B001-06	3/8
29-B001-08	1/2
29-B001-10	5/8
29-B001-12	3/4
29-B001-16	1"
29-B001-20	1.1/4
29-B001-24	1.1/2
29-B301-06	6mm



**#2B
Tube Nut**

Code	Tube	Thread
29-B002-02	1/8	5/16x20
29-B002-03	3/16	3/8x20
29-B002-04	1/4	7/16x20
29-B002-05	5/16	1/2x20
29-B002-06	3/8	9/16x20
29-B002-08	1/2	3/4x20
29-B002-10	5/8	7/8x20
29-B002-12	3/4	1"x20
29-B002-16	1"	1.5/16x20
29-B002-20	1.1/4	1.5/8x20
29-B002-24	1.1/2	1.15/16x20
29-B302-06	6mm	7/16x20



**#3B
Male
Connector**

Code	Tube	Male
29-B003-0202	1/8	1/8 BSPT
29-B003-0204	1/8	1/4 BSPT
29-B003-0302	3/16	1/8 BSPT
29-B003-0304	3/16	1/4 BSPT
29-B003-0402	1/4	1/8 BSPT
29-B003-0404	1/4	1/4 BSPT
29-B003-0406	1/4	3/8 BSPT
29-B003-0408	1/4	1/2 BSPT
29-B003-0502	5/16	1/8 BSPT
29-B003-0504	5/16	1/4 BSPT
29-B003-0506	5/16	3/8 BSPT
29-B003-0602	3/8	1/8 BSPT
29-B003-0604	3/8	1/4 BSPT
29-B003-0606	3/8	3/8 BSPT
Continued next Column		

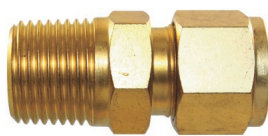

**#3B
Male
Connector**

Code	Tube	Male
From Previous Column		
29-B003-0608	3/8	1/2 BSPT
29-B003-0612	3/8	3/4 BSPT
29-B003-0804	1/2	1/4 BSPT
29-B003-0806	1/2	3/8 BSPT
29-B003-0808	1/2	1/2 BSPT
29-B003-0812	1/2	3/4 BSPT
29-B003-1006	5/8	3/8 BSPT
29-B003-1008	5/8	1/2 BSPT
29-B003-1012	5/8	3/4 BSPT
29-B003-1208	3/4	1/2 BSPT
29-B003-1212	3/4	3/4 BSPT
29-B003-1216	3/4	1" BSPT
29-B003-1612	1"	3/4 BSPT
29-B003-1616	1"	1" BSPT
29-B003-2016	1.1/4	1" BSPT
29-B003-2020	1.1/4	1.1/4 BSPT
29-B003-2420	1.1/2	1.1/4 BSPT
29-B003-2424	1.1/2	1.1/2 BSPT
29-B103-0602	3/8	1/8 BSPP
29-B203-0202	1/8	1/8 NPT
29-B203-0204	1/8	1/4 NPT
29-B203-0302	3/16	1/8 NPT
29-B203-0304	3/16	1/4 NPT
29-B203-0402	1/4	1/8 NPT
29-B203-0404	1/4	1/4 NPT
29-B203-0406	1/4	3/8 NPT
29-B203-0408	1/4	1/2 NPT
29-B203-0502	5/16	1/8 NPT
29-B203-0504	5/16	1/4 NPT
29-B203-0506	5/16	3/8 NPT
29-B203-0602	3/8	1/8 NPT
29-B203-0604	3/8	1/4 NPT
29-B203-0606	3/8	3/8 NPT
29-B203-0608	3/8	1/2 NPT
29-B203-0804	1/2	1/4 NPT
29-B203-0806	1/2	3/8 NPT
29-B203-0808	1/2	1/2 NPT
29-B203-0812	1/2	3/4 NPT
29-B203-0816	1/2	1" NPT
29-B203-1006	5/8	3/8 NPT
29-B203-1008	5/8	1/2 NPT
29-B203-1012	5/8	3/4 NPT
29-B203-1208	3/4	1/2 NPT
29-B203-1212	3/4	3/4 NPT
29-B203-1216	3/4	1" NPT
29-B203-1612	1"	3/4 NPT
29-B203-1616	1"	1" NPT
29-B303-0604	6mm	1/4 BSPT
29-B303-0608	6mm	1/2 BSPT

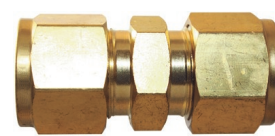

**#4B
Tube
Union**

Code	Tube
29-B004-02	1/8
29-B004-03	3/16
29-B004-04	1/4
29-B004-05	5/16
29-B004-06	3/8
29-B004-08	1/2
29-B004-10	5/8
29-B004-12	3/4
29-B004-16	1"
29-B004-20	1.1/4
29-B004-24	1.1/2

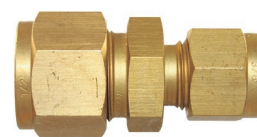

**#4RB
Reducing
Tube Union**

Code	Tube	Tube
29-B004R-0402	1/4	1/8
29-B004R-0403	1/4	3/16
29-B004R-0504	5/16	1/4
29-B004R-0604	3/8	1/4
29-B004R-0605	3/8	5/16
29-B004R-0804	1/2	1/4
29-B004R-0806	1/2	3/8
29-B004R-1008	5/8	1/2
29-B004R-1208	3/4	1/2
29-B004R-1210	3/4	5/8
29-B004R-1612	1"	3/4



**#5B
Male
Elbow**

Code	Tube	Male
29-B005-0202	1/8	1/8 BSPT
29-B005-0204	1/8	1/4 BSPT
29-B005-0302	3/16	1/8 BSPT
29-B005-0402	1/4	1/8 BSPT
29-B005-0404	1/4	1/4 BSPT
29-B005-0406	1/4	3/8 BSPT
29-B005-0502	5/16	1/8 BSPT
29-B005-0504	5/16	1/4 BSPT
29-B005-0506	5/16	3/8 BSPT
29-B005-0602	3/8	1/8 BSPT
29-B005-0604	3/8	1/4 BSPT
29-B005-0606	3/8	3/8 BSPT
29-B005-0608	3/8	1/2 BSPT
Continued Next Page		

Brass Twin Ferrule Compression Fittings (Category 29)



#5B
Male
Elbow

Code	Tube	Male
From Previous Page		
29-B005-0804	1/2	1/4 BSPT
29-B005-0806	1/2	3/8 BSPT
29-B005-0808	1/2	1/2 BSPT
29-B005-0812	1/2	3/4 BSPT
29-B005-1006	5/8	3/8 BSPT
29-B005-1008	5/8	1/2 BSPT
29-B005-1208	3/4	1/2 BSPT
29-B005-1212	3/4	3/4 BSPT
29-B005-1612	1"	3/4 BSPT
29-B005-1616	1"	1" BSPT
29-B005-2016	1.1/4	1" BSPT
29-B005-2424	1.1/2	1.1/2 BSPT
29-B205-0202	1/8	1/8 NPT
29-B205-0204	1/8	1/4 NPT
29-B205-0302	3/16	1/8 NPT
29-B205-0402	1/4	1/8 NPT
29-B205-0404	1/4	1/4 NPT
29-B205-0406	1/4	3/8 NPT
29-B205-0408	1/4	1/2 NPT
29-B205-0502	5/16	1/8 NPT
29-B205-0504	5/16	1/4 NPT
29-B205-0602	3/8	1/8 NPT
29-B205-0604	3/8	1/4 NPT
29-B205-0606	3/8	3/8 NPT
29-B205-0608	3/8	1/2 NPT
29-B205-0804	1/2	1/4 NPT
29-B205-0806	1/2	3/8 NPT
29-B205-0808	1/2	1/2 NPT
29-B205-0812	1/2	3/4 NPT
29-B205-1008	5/8	1/2 NPT
29-B205-1208	3/4	1/2 NPT
29-B205-1212	3/4	3/4 NPT
29-B205-1612	1"	3/4 NPT
29-B205-1616	1"	1" NPT



#11B
Elbow Tube
Union

Code	Tube
29-B011-02	1/8
29-B011-03	3/16
29-B011-04	1/4
29-B011-05	5/16
29-B011-06	3/8
29-B011-08	1/2
29-B011-10	5/8
29-B011-12	3/4
29-B011-16	1"



#10B
Female
Connector

Code	Tube	Female
29-B010-0202	1/8	1/8 BSPT
29-B010-0302	3/16	1/8 BSPT
29-B010-0402	1/4	1/8 BSPT
29-B010-0404	1/4	1/4 BSPT
29-B010-0406	1/4	3/8 BSPT
29-B010-0408	1/4	1/2 BSPT
29-B010-0502	5/16	1/8 BSPT
29-B010-0504	5/16	1/4 BSPT
29-B010-0602	3/8	1/8 BSPT
29-B010-0604	3/8	1/4 BSPT
29-B010-0606	3/8	3/8 BSPT
29-B010-0608	3/8	1/2 BSPT
29-B010-0804	1/2	1/4 BSPT
29-B010-0806	1/2	3/8 BSPT
29-B010-0808	1/2	1/2 BSPT
29-B010-0812	1/2	3/4 BSPT
29-B010-1008	5/8	1/2 BSPT
29-B010-1208	3/4	1/2 BSPT
29-B010-1212	3/4	3/4 BSPT
29-B010-1616	1"	1" BSPT
29-B010-2016	1.1/4	1" BSPT
29-B010-2020	1.1/4	1.1/4 BSPT
29-B210-0202	1/8	1/8 NPT
29-B210-0402	1/4	1/8 NPT
29-B210-0404	1/4	1/4 NPT
29-B210-0406	1/4	3/8 NPT
29-B210-0408	1/4	1/2 NPT
29-B210-0502	5/16	1/8 NPT
29-B210-0604	3/8	1/4 NPT
29-B210-0606	3/8	3/8 NPT
29-B210-0608	3/8	1/2 NPT
29-B210-0804	1/2	1/4 NPT
29-B210-0806	1/2	3/8 NPT
29-B210-0808	1/2	1/2 NPT
29-B210-0812	1/2	3/4 NPT
29-B210-1208	3/4	1/2 NPT
29-B210-1212	3/4	3/4 NPT
29-B210-1612	1"	3/4 NPT
29-B210-1616	1"	1" NPT



#12B
Male Branch
Tee

Code	Tube	Male
29-B012-0202	1/8	1/8 BSPT
29-B012-0302	3/16	1/8 BSPT
29-B012-0402	1/4	1/8 BSPT
29-B012-0404	1/4	1/4 BSPT
29-B012-0502	5/16	1/8 BSPT
29-B012-0504	5/16	1/4 BSPT
29-B012-0604	3/8	1/4 BSPT
29-B012-0606	3/8	3/8 BSPT
29-B012-0804	1/2	1/4 BSPT
29-B012-0806	1/2	3/8 BSPT
29-B012-0808	1/2	1/2 BSPT
29-B012-1616	1"	1" BSPT
29-B212-0202	1/8	1/8 NPT
29-B212-0402	1/4	1/8 NPT
29-B212-0404	1/4	1/4 NPT
29-B212-0604	3/8	1/4 NPT
29-B212-0606	3/8	3/8 NPT
29-B212-0806	1/2	3/8 NPT



#12FB
Female
Branch Tee

Code	Tube	Female
29-B012F-0202	1/8	1/8 BSPT
29-B012F-0402	1/4	1/8 BSPT
29-B012F-0404	1/4	1/4 BSPT
29-B012F-0604	3/8	1/4 BSPT
29-B012F-0806	1/2	3/8 BSPT
29-B012F-0808	1/2	1/2 BSPT
29-B012F-1008	5/8	1/2 BSPT
29-B012F-1208	3/4	1/2 BSPT
29-B012F-1212	3/4	3/4 BSPT
29-B012F-1612	1"	3/4 BSPT
29-B012F-1616	1"	1" BSPT
29-B012F-2016	1.1/4	1" BSPT
29-B212F-0402	1/4	1/8 NPT
29-B212F-0404	1/4	1/4 NPT
29-B212F-0604	3/8	1/4 NPT
29-B212F-0806	1/2	3/8 NPT
29-B212F-1008	5/8	1/2 NPT
29-B212F-1212	3/4	3/4 NPT



Copper Tube also available in annealed coils and hard drawn lengths.

Refer Category 45

Brass Twin Ferrule Compression Fittings (Category 29)



#13B
Male Run Tee

Code	Tube	Male
29-B013-0402	1/4	1/8 BSPT
29-B013-0404	1/4	1/4 BSPT
29-B013-0604	3/8	1/4 BSPT
29-B013-0606	3/8	3/8 BSPT
29-B013-0806	1/2	3/8 BSPT
29-B013-0808	1/2	1/2 BSPT
29-B013-1212	3/4	3/4 BSPT
29-B213-0202	1/8	1/8 NPT
29-B213-0402	1/4	1/8 NPT
29-B213-0404	1/4	1/4 NPT
29-B213-0604	3/8	1/4 NPT
29-B213-0606	3/8	3/8 NPT
29-B213-0806	1/2	3/8 NPT
29-B213-0808	1/2	1/2 NPT



#13FB
Female Run Tee

Code	Tube	Female
29-B013F-0402	1/4	1/8 BSPT
29-B013F-0404	1/4	1/4 BSPT
29-B013F-0604	3/8	1/4 BSPT
29-B013F-0806	1/2	3/8 BSPT
29-B013F-0808	1/2	1/2 BSPT
29-B013F-1612	1"	3/4 BSPT
29-B213F-0402	1/4	1/8 NPT
29-B213F-0404	1/4	1/4 NPT
29-B213F-0604	3/8	1/4 NPT
29-B213F-0806	1/2	3/8 NPT
29-B213F-0808	1/2	1/2 NPT



#14B
Tee Tube Union

Code	Tube
29-B014-02	1/8
29-B014-03	3/16
29-B014-04	1/4
29-B014-05	5/16
29-B014-06	3/8
29-B014-08	1/2
29-B014-10	5/8
29-B014-12	3/4
29-B014-16	1"



#15B
Female Elbow

Code	Tube	Female
29-B015-0202	1/8	1/8 BSPT
29-B015-0402	1/4	1/8 BSPT
29-B015-0404	1/4	1/4 BSPT
29-B015-0408	1/4	1/2 BSPT
29-B015-0504	5/16	1/4 BSPT
29-B015-0604	3/8	1/4 BSPT
29-B015-0606	3/8	3/8 BSPT
29-B015-0804	1/2	1/4 BSPT
29-B015-0806	1/2	3/8 BSPT
29-B015-0808	1/2	1/2 BSPT
29-B015-1006	5/8	3/8 BSPT
29-B015-1008	5/8	1/2 BSPT
29-B015-1208	3/4	1/2 BSPT
29-B015-1212	3/4	3/4 BSPT
29-B015-1612	1"	3/4 BSPT
29-B015-1616	1"	1" BSPT
29-B215-0202	1/8	1/8 NPT
29-B215-0302	3/16	1/8 NPT
29-B215-0402	1/4	1/8 NPT
29-B215-0404	1/4	1/4 NPT
29-B215-0406	1/4	3/8 NPT
29-B215-0408	1/4	1/2 NPT
29-B215-0502	5/16	1/8 NPT
29-B215-0604	3/8	1/4 NPT
29-B215-0606	3/8	3/8 NPT
29-B215-0608	3/8	1/2 NPT
29-B215-0804	1/2	1/4 NPT
29-B215-0806	1/2	3/8 NPT
29-B215-0808	1/2	1/2 NPT
29-B215-1008	5/8	1/2 NPT
29-B215-1212	3/4	3/4 NPT
29-B215-1612	1"	3/4 NPT

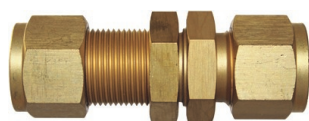

#31B
Bulkhead Union

Code	Tube
29-B031-02	1/8
29-B031-03	3/16
29-B031-04	1/4
29-B031-05	5/16
29-B031-06	3/8
29-B031-08	1/2
29-B031-10	5/8
29-B031-12	3/4
29-B031-16	1"
29-B031-20	1.1/4



#31FB
Female Bulkhead

Code	Tube	Female
29-B031F-0302	3/16	1/8 BSPT
29-B031F-0402	1/4	1/8 BSPT
29-B031F-0404	1/4	1/4 BSPT
29-B031F-0604	3/8	1/4 BSPT
29-B031F-0606	3/8	3/8 BSPT
29-B031F-0806	1/2	3/8 BSPT
29-B031F-0808	1/2	1/2 BSPT
29-B231F-0202	1/8	1/8 NPT
29-B231F-0404	1/4	1/4 NPT
29-B231F-0604	3/8	1/4 NPT
29-B231F-0606	3/8	3/8 NPT
29-B231F-0806	1/2	3/8 NPT
29-B231F-0808	1/2	1/2 NPT

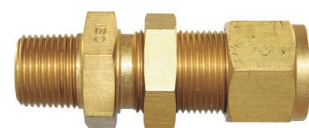

#31MB
Male Bulkhead

Code	Tube	Male
29-B031M-0402	1/4	1/8 BSPT
29-B031M-0404	1/4	1/4 BSPT
29-B031M-0604	3/8	1/4 BSPT
29-B031M-0606	3/8	3/8 BSPT
29-B031M-0806	1/2	3/8 BSPT
29-B031M-0808	1/2	1/2 BSPT
29-B231M-0402	1/4	1/8 NPT
29-B231M-0404	1/4	1/4 NPT
29-B231M-0604	3/8	1/4 NPT
29-B231M-0606	3/8	3/8 NPT
29-B231M-0806	1/2	3/8 NPT
29-B231M-0808	1/2	1/2 NPT

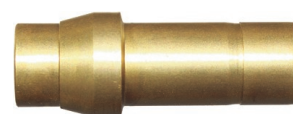

#44B
Port Connector

Code	Tube
29-B044-04	1/4
29-B044-06	3/8
29-B044-08	1/2
29-B044-12	3/4



#44RB
Reducing Port Connector

Code	Tube	Stem
29-B044R-0604	3/8	1/4
29-B044R-0806	1/2	3/8
29-B044R-1208	3/4	1/2

Brass Twin Ferrule Compression Fittings (Category 29)



#56B
Tube Plug

Code	Tube
29-B056-02	1/8
29-B056-03	3/16
29-B056-04	1/4
29-B056-06	3/8
29-B056-08	1/2
29-B056-12	3/4
29-B056-16	1"



#65B
Tube Cap

Code	Tube
29-B065-02	1/8
29-B065-03	3/16
29-B065-04	1/4
29-B065-06	3/8
29-B065-08	1/2
29-B065-12	3/4
29-B065-16	1"



#72MB
Male Tube
Adaptor

Code	Stem	Male
29-B072M-0302	3/16	1/8 BSPT
29-B072M-0402	1/4	1/8 BSPT
29-B072M-0404	1/4	1/4 BSPT
29-B072M-0406	1/4	3/8 BSPT
29-B072M-0408	1/4	1/2 BSPT
29-B072M-0604	3/8	1/4 BSPT
29-B072M-0606	3/8	3/8 BSPT
29-B072M-0608	3/8	1/2 BSPT
29-B072M-0804	1/2	1/4 BSPT
29-B072M-0806	1/2	3/8 BSPT
29-B072M-0808	1/2	1/2 BSPT
29-B072M-1212	3/4	3/4 BSPT
29-B272M-0204	1/8	1/4 NPT
29-B272M-0402	1/4	1/8 NPT
29-B272M-0404	1/4	1/4 NPT
29-B272M-0406	1/4	3/8 NPT
29-B272M-0408	1/4	1/2 NPT
29-B272M-0604	3/8	1/4 NPT
29-B272M-0606	3/8	3/8 NPT
29-B272M-0608	3/8	1/2 NPT
29-B272M-0804	1/2	1/4 NPT
29-B272M-0806	1/2	3/8 NPT
29-B272M-0808	1/2	1/2 NPT



#68B
Union Cross

Code	Tube
29-B068-02	1/8
29-B068-04	1/4
29-B068-05	5/16
29-B068-06	3/8
29-B068-08	1/2

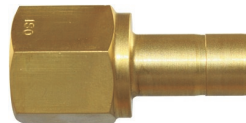

#72FB
Female Tube
Adaptor

Code	Stem	Female
29-B072F-0402	1/4	1/8 BSPT
29-B072F-0404	1/4	1/4 BSPT
29-B072F-0406	1/4	3/8 BSPT
29-B072F-0604	3/8	1/4 BSPT
29-B072F-0606	3/8	3/8 BSPT
29-B072F-0608	3/8	1/2 BSPT
29-B072F-0806	1/2	3/8 BSPT
29-B072F-0808	1/2	1/2 BSPT
29-B072F-1612	1"	3/4 BSPT
29-B072F-1616	1"	1" BSPT
29-B272F-0204	1/8	1/4 NPT
29-B272F-0402	1/4	1/8 NPT
29-B272F-0404	1/4	1/4 NPT
29-B272F-0406	1/4	3/8 NPT
29-B272F-0604	3/8	1/4 NPT
29-B272F-0606	3/8	3/8 NPT
29-B272F-0608	3/8	1/2 NPT
29-B272F-0806	1/2	3/8 NPT
29-B272F-0808	1/2	1/2 NPT
29-B272F-1008	5/8	1/2 NPT

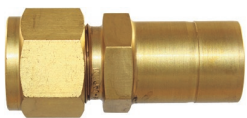

#72AB
Reducing
Tube Adaptor

Code	Stem	Tube
29-B072A-0204	1/8	1/4
29-B072A-0402	1/4	1/8
29-B072A-0406	1/4	3/8
29-B072A-0408	1/4	1/2
29-B072A-0504	5/16	1/4
29-B072A-0604	3/8	1/4
29-B072A-0608	3/8	1/2
29-B072A-0804	1/2	1/4
29-B072A-0806	1/2	3/8
29-B072A-1208	3/4	1/2

Note : The pressure rating of twin ferrule fittings exceeds that of the tube, provided the tube is seamless and of a softer material than the fitting.

They can be reassembled multiple times by tightening slightly from the original tight position. Components must be kept free of contaminants while disassembled.

Assembly instruction for Twin Ferrule Fittings up to 1"

1. Cut the tube squarely and free from burrs.
2. Insert the tube into the fitting, ensuring it is completely in contact with the shoulder of the fitting, then finger tighten the nut.
3. Mark the starting position and tighten 1.1/4 turns with a spanner from finger tight.

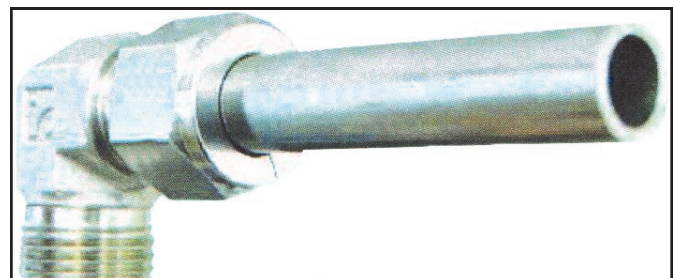
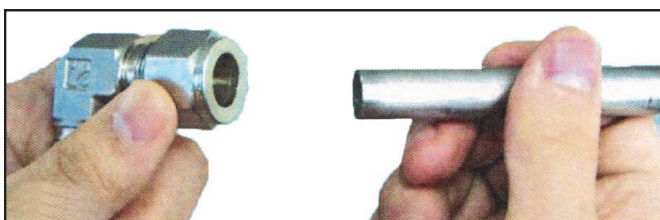

Stainless Steel Twin Ferrule Compression Fittings (Category 29)

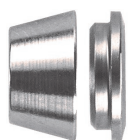

#1SS
Ferrule Set

Code	Tube
29-S001-01	1/16
29-S001-02	1/8
29-S001-03	3/16
29-S001-04	1/4
29-S001-05	5/16
29-S001-06	3/8
29-S001-08	1/2
29-S001-10	5/8
29-S001-12	3/4
29-S001-16	1"
29-S301-04	4mm
29-S301-06	6mm
29-S301-10	10mm
29-S301-12	12mm
29-S301-15	15mm



#2SS
Tube Nut

Code	Tube	Thread
29-S002-01	1/16	10-32
29-S002-02	1/8	5/16x20
29-S002-03	3/16	3/8x20
29-S002-04	1/4	7/16x20
29-S002-05	5/16	1/2x20
29-S002-06	3/8	9/16x20
29-S002-08	1/2	3/4x20
29-S002-10	5/8	7/8x20
29-S002-12	3/4	1"x20
29-S002-16	1"	1.5/16x20
29-S302-04	4mm	3/8x20
29-S302-06	6mm	7/16x20
29-S302-08	8mm	1/2x20
29-S302-12	12mm	3/4x20
29-S302-15	15mm	7/8x20

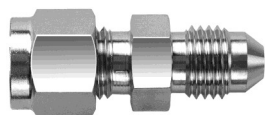

#3SS
JIC Male
Connector

Code	Tube	Male
29-S603-0404	1/4	7/16 JIC
29-S603-0505	5/16	1/2 JIC
29-S603-0604	3/8	7/16 JIC
29-S603-0606	3/8	9/16 JIC
29-S603-0808	1/2	3/4 JIC

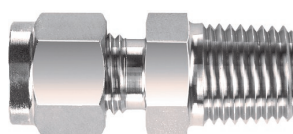

#3SS
Male
Connector

Code	Tube	Male
29-S003-0102	1/16	1/8 BSPT
29-S003-0202	1/8	1/8 BSPT
29-S003-0204	1/8	1/4 BSPT
29-S003-0208	1/8	1/2 BSPT
29-S003-0302	3/16	1/8 BSPT
29-S003-0304	3/16	1/4 BSPT
29-S003-0402	1/4	1/8 BSPT
29-S003-0404	1/4	1/4 BSPT
29-S003-0406	1/4	3/8 BSPT
29-S003-0408	1/4	1/2 BSPT
29-S003-0412	1/4	3/4 BSPT
29-S003-0502	5/16	1/8 BSPT
29-S003-0504	5/16	1/4 BSPT
29-S003-0506	5/16	3/8 BSPT
29-S003-0508	5/16	1/2 BSPT
29-S003-0602	3/8	1/8 BSPT
29-S003-0604	3/8	1/4 BSPT
29-S003-0606	3/8	3/8 BSPT
29-S003-0608	3/8	1/2 BSPT
29-S003-0612	3/8	3/4 BSPT
29-S003-0802	1/2	1/8 BSPT
29-S003-0804	1/2	1/4 BSPT
29-S003-0806	1/2	3/8 BSPT
29-S003-0808	1/2	1/2 BSPT
29-S003-0812	1/2	3/4 BSPT
29-S003-0816	1/2	1" BSPT
29-S003-1006	5/8	3/8 BSPT
29-S003-1008	5/8	1/2 BSPT
29-S003-1012	5/8	3/4 BSPT
29-S003-1206	3/4	3/8 BSPT
29-S003-1208	3/4	1/2 BSPT
29-S003-1212	3/4	3/4 BSPT
29-S003-1216	3/4	1" BSPT
29-S003-1608	1"	1/2 BSPT
29-S003-1612	1"	3/4 BSPT
29-S003-1616	1"	1" BSPT
29-S103-0402	1/4	1/8 BSPP
29-S103-0404	1/4	1/4 BSPP
29-S103-0406	1/4	3/8 BSPP
29-S103-0808	1/2	1/2 BSPP
29-S103-2016	1.1/4	1" BSPP
29-S203-0101	1/16	1/16 NPT
29-S203-0202	1/8	1/8 NPT
29-S203-0204	1/8	1/4 NPT
29-S203-0302	3/16	1/8 NPT
29-S203-0304	3/16	1/4 NPT
29-S203-0401	1/4	1/16 NPT
29-S203-0402	1/4	1/8 NPT
Continued next Column		

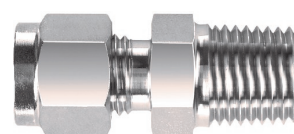

#3SS
Male
Connector

Code	Tube	Male
From Previous Column		
29-S203-0404	1/4	1/4 NPT
29-S203-0406	1/4	3/8 NPT
29-S203-0408	1/4	1/2 NPT
29-S203-0412	1/4	3/4 NPT
29-S203-0502	5/16	1/8 NPT
29-S203-0504	5/16	1/4 NPT
29-S203-0602	3/8	1/8 NPT
29-S203-0604	3/8	1/4 NPT
29-S203-0606	3/8	3/8 NPT
29-S203-0608	3/8	1/2 NPT
29-S203-0612	3/8	3/4 NPT
29-S203-0616	3/8	1" NPT
29-S203-0802	1/2	1/8 NPT
29-S203-0804	1/2	1/4 NPT
29-S203-0806	1/2	3/8 NPT
29-S203-0808	1/2	1/2 NPT
29-S203-0812	1/2	3/4 NPT
29-S203-0816	1/2	1" NPT
29-S203-1006	5/8	3/8 NPT
29-S203-1008	5/8	1/2 NPT
29-S203-1012	5/8	3/4 NPT
29-S203-1208	3/4	1/2 NPT
29-S203-1212	3/4	3/4 NPT
29-S203-1216	3/4	1" NPT
29-S203-1608	1"	1/2 NPT
29-S203-1612	1"	3/4 NPT
29-S203-1616	1"	1" NPT
29-S203-2016	1.1/4	1" NPT
29-S303-0402	4mm	1/8 BSPT
29-S303-0602	6mm	1/8 BSPT
29-S303-0604	6mm	1/4 BSPT
29-S303-0606	6mm	3/8 BSPT
29-S303-0608	6mm	1/2 BSPT
29-S303-1004	10mm	1/4 BSPT
29-S303-1006	10mm	3/8 BSPT
29-S303-1008	10mm	1/2 BSPT
29-S303-1204	12mm	1/4 BSPT
29-S303-1206	12mm	3/8 BSPT
29-S303-1208	12mm	1/2 BSPT

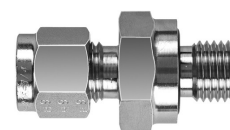

#3SS
O-Seal Male
Connector

Code	Tube	Male
29-S703-0202	1/8	5/16 SAE
29-S703-0404	1/4	7/16 SAE

Stainless Steel Twin Ferrule Compression Fittings (Category 29)

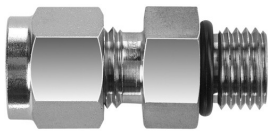

#3SS
UNO Male
Connector

Code	Tube	Male
29-S803-0404	1/4	7/16 UNO
29-S803-0806	1/2	9/16 UNO
29-S803-1208	3/4	3/4 UNO

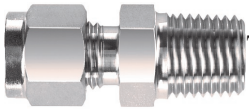

#3TSS
Thermocouple
Male Conn

Code	Tube	Male
29-S003T-0608	3/8	1/2 BSPT
29-S003T-0808	1/2	1/2 BSPT
29-S203T-0604	3/8	1/4 NPT
29-S203T-0808	1/2	1/2 NPT

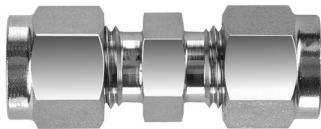

#4SS
Tube
Union

Code	Tube
29-S004-01	1/16
29-S004-02	1/8
29-S004-03	3/16
29-S004-04	1/4
29-S004-05	5/16
29-S004-06	3/8
29-S004-08	1/2
29-S004-10	5/8
29-S004-12	3/4
29-S004-16	1"
29-S004-32	2"
29-S304-06	6mm
29-S304-08	8mm
29-S304-10	10mm
29-S304-12	12mm
29-S304-15	15mm



#5SS
UNO Positionable
Male Elbow

Code	Tube	Male
29-S805-0808	1/2	3/4 UNO

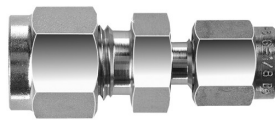

#4RSS
Reducing
Tube Union

Code	Tube	Tube
29-S004R-0201	1/8	1/16
29-S004R-0401	1/4	1/16
29-S004R-0402	1/4	1/8
29-S004R-04M06	1/4	6mm
29-S004R-0504	5/16	1/4
29-S004R-0602	3/8	1/8
29-S004R-0604	3/8	1/4
29-S004R-0605	3/8	5/16
29-S004R-0804	1/2	1/4
29-S004R-0806	1/2	3/8
29-S004R-1005	5/8	5/16
29-S004R-1008	5/8	1/2
29-S004R-1206	3/4	3/8
29-S004R-1208	3/4	1/2
29-S004R-1608	1"	1/2
29-S004R-1612	1"	3/4
29-S304R-10I06	10mm	3/8
29-S304R-12I06	12mm	3/8



#5SS
Male
Elbow

Code	Tube	Male
29-S005-0202	1/8	1/8 BSPT
29-S005-0204	1/8	1/4 BSPT
29-S005-0302	3/16	1/8 BSPT
29-S005-0402	1/4	1/8 BSPT
29-S005-0404	1/4	1/4 BSPT
29-S005-0406	1/4	3/8 BSPT
29-S005-0408	1/4	1/2 BSPT
29-S005-0502	5/16	1/8 BSPT
29-S005-0504	5/16	1/4 BSPT
29-S005-0506	5/16	3/8 BSPT
29-S005-0508	5/16	1/2 BSPT
29-S005-0602	3/8	1/8 BSPT
29-S005-0604	3/8	1/4 BSPT
29-S005-0606	3/8	3/8 BSPT
29-S005-0608	3/8	1/2 BSPT
29-S005-0804	1/2	1/4 BSPT
29-S005-0806	1/2	3/8 BSPT
29-S005-0808	1/2	1/2 BSPT
29-S005-0812	1/2	3/4 BSPT
29-S005-1006	5/8	3/8 BSPT
29-S005-1008	5/8	1/2 BSPT
29-S005-1208	3/4	1/2 BSPT
29-S005-1212	3/4	3/4 BSPT
29-S005-1612	1"	3/4 BSPT
29-S005-1616	1"	1" BSPT

Continued next Column



#5SS
Male
Elbow

Code	Tube	Male
From Previous Column		
29-S205-0202	1/8	1/8 NPT
29-S205-0204	1/8	1/4 NPT
29-S205-0302	3/16	1/8 NPT
29-S205-0304	3/16	1/4 NPT
29-S205-0402	1/4	1/8 NPT
29-S205-0404	1/4	1/4 NPT
29-S205-0406	1/4	3/8 NPT
29-S205-0408	1/4	1/2 NPT
29-S205-0502	5/16	1/8 NPT
29-S205-0504	5/16	1/4 NPT
29-S205-0506	5/16	3/8 NPT
29-S205-0602	3/8	1/8 NPT
29-S205-0604	3/8	1/4 NPT
29-S205-0606	3/8	3/8 NPT
29-S205-0608	3/8	1/2 NPT
29-S205-0612	3/8	3/4 NPT
29-S205-0804	1/2	1/4 NPT
29-S205-0806	1/2	3/8 NPT
29-S205-0808	1/2	1/2 NPT
29-S205-0812	1/2	3/4 NPT
29-S205-1004	5/8	1/4 NPT
29-S205-1006	5/8	3/8 NPT
29-S205-1008	5/8	1/2 NPT
29-S205-1208	3/4	1/2 NPT
29-S205-1212	3/4	3/4 NPT
29-S205-1612	1"	3/4 NPT
29-S205-1616	1"	1" NPT
29-S305-0602	6mm	1/8 BSPT
29-S305-0604	6mm	1/4 BSPT
29-S305-0608	6mm	1/2 BSPT
29-S305-1004	10mm	1/4 BSPT
29-S305-1006	10mm	3/8 BSPT
29-S305-1008	10mm	1/2 BSPT
29-S305-1204	12mm	1/4 BSPT
29-S305-1206	12mm	3/8 BSPT
29-S305-1208	12mm	1/2 BSPT

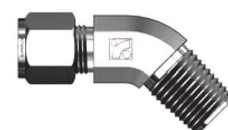

#5DSS
45° Male
Elbow

Code	Tube	Male
29-S005D-0606	3/8	3/8 BSPT

Stainless Steel Twin Ferrule Compression Fittings (Category 29)

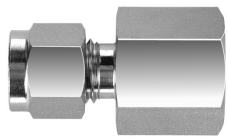

#10SS
Female
Connector

Code	Tube	Female
29-S010-0202	1/8	1/8 BSPT
29-S010-0302	3/16	1/8 BSPT
29-S010-0402	1/4	1/8 BSPT
29-S010-0404	1/4	1/4 BSPT
29-S010-0406	1/4	3/8 BSPT
29-S010-0408	1/4	1/2 BSPT
29-S010-0502	5/16	1/8 BSPT
29-S010-0504	5/16	1/4 BSPT
29-S010-0602	3/8	1/8 BSPT
29-S010-0604	3/8	1/4 BSPT
29-S010-0606	3/8	3/8 BSPT
29-S010-0608	3/8	1/2 BSPT
29-S010-0804	1/2	1/4 BSPT
29-S010-0806	1/2	3/8 BSPT
29-S010-0808	1/2	1/2 BSPT
29-S010-0812	1/2	3/4 BSPT
29-S010-1008	5/8	1/2 BSPT
29-S010-1208	3/4	1/2 BSPT
29-S010-1212	3/4	3/4 BSPT
29-S010-1616	1"	1" BSPT
29-S110-0408	1/4	1/2 BSPP
29-S110-0808	1/2	1/2 BSPP
29-S210-0202	1/8	1/8 NPT
29-S210-0204	1/8	1/4 NPT
29-S210-0302	3/16	1/8 NPT
29-S210-0402	1/4	1/8 NPT
29-S210-0404	1/4	1/4 NPT
29-S210-0406	1/4	3/8 NPT
29-S210-0408	1/4	1/2 NPT
29-S210-0502	5/16	1/8 NPT
29-S210-0504	5/16	1/4 NPT
29-S210-0602	3/8	1/8 NPT
29-S210-0604	3/8	1/4 NPT
29-S210-0606	3/8	3/8 NPT
29-S210-0608	3/8	1/2 NPT
29-S210-0804	1/2	1/4 NPT
29-S210-0806	1/2	3/8 NPT
29-S210-0808	1/2	1/2 NPT
29-S210-0812	1/2	3/4 NPT
29-S210-1006	5/8	3/8 NPT
29-S210-1008	5/8	1/2 NPT
29-S210-1208	3/4	1/2 NPT
29-S210-1212	3/4	3/4 NPT
29-S210-1612	1"	3/4 NPT
29-S210-1616	1"	1" NPT

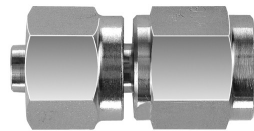

#10FSS
JIC Female
Tube Adaptor

Code	Tube (F)	Female
29-S610F-0808	1/2	3/4 JIC



#11SS
Elbow Tube
Union

Code	Tube
29-S011-02	1/8
29-S011-03	3/16
29-S011-04	1/4
29-S011-05	5/16
29-S011-06	3/8
29-S011-08	1/2
29-S011-10	5/8
29-S011-12	3/4
29-S011-16	1"
29-S011-32	2"
29-S311-06	6mm
29-S311-10	10mm
29-S311-12	12mm
29-S311-15	15mm

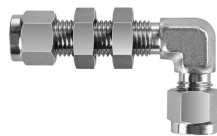

#11BHSS
Elbow Bulkhead
Tube Union

Code	Tube
29-S011BH-04	1/4
29-S011BH-08	1/2
29-S011BH-12	3/4

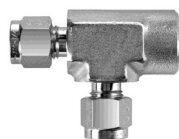

#13FSS
Female Run
Tee

Code	Tube	Female
29-S013F-0402	1/4	1/8 BSPT
29-S013F-0404	1/4	1/4 BSPT
29-S013F-0604	3/8	1/4 BSPT
29-S013F-0802	1/2	1/8 BSPT
29-S013F-0806	1/2	3/8 BSPT
29-S013F-1212	3/4	3/4 BSPT
29-S213F-0402	1/4	1/8 NPT
29-S213F-0404	1/4	1/4 NPT
29-S213F-0604	3/8	1/4 NPT
29-S213F-0606	3/8	3/8 NPT
29-S213F-0806	1/2	3/8 NPT
29-S213F-0808	1/2	1/2 NPT
29-S213F-1212	3/4	3/4 NPT

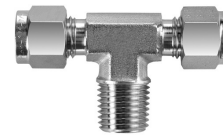

#12SS
Male Branch
Tee

Code	Tube	Male
29-S012-0302	3/16	1/8 BSPT
29-S012-0402	1/4	1/8 BSPT
29-S012-0404	1/4	1/4 BSPT
29-S012-0504	5/16	1/4 BSPT
29-S012-0506	5/16	3/8 BSPT
29-S012-0604	3/8	1/4 BSPT
29-S012-0606	3/8	3/8 BSPT
29-S012-0804	1/2	1/4 BSPT
29-S012-0806	1/2	3/8 BSPT
29-S012-0808	1/2	1/2 BSPT
29-S012-1008	5/8	1/2 BSPT
29-S012-1208	3/4	1/2 BSPT
29-S212-0202	1/8	1/8 NPT
29-S212-0204	1/8	1/4 NPT
29-S212-0402	1/4	1/8 NPT
29-S212-0404	1/4	1/4 NPT
29-S212-0604	3/8	1/4 NPT
29-S212-0606	3/8	3/8 NPT
29-S212-0804	1/2	1/4 NPT
29-S212-0806	1/2	3/8 NPT
29-S212-0808	1/2	1/2 NPT
29-S212-1008	5/8	1/2 NPT
29-S212-1212	3/4	3/4 NPT

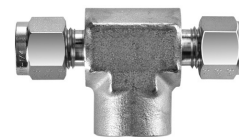

#12FSS
Female
Branch Tee

Code	Tube	Female
29-S012F-0202	1/8	1/8 BSPT
29-S012F-0402	1/4	1/8 BSPT
29-S012F-0404	1/4	1/4 BSPT
29-S012F-0604	3/8	1/4 BSPT
29-S012F-0606	3/8	3/8 BSPT
29-S012F-0804	1/2	1/4 BSPT
29-S012F-0806	1/2	3/8 BSPT
29-S012F-0808	1/2	1/2 BSPT
29-S012F-1002	5/8	1/8 BSPT
29-S012F-1616	1"	1" BSPT
29-S212F-0202	1/8	1/8 NPT
29-S212F-0404	1/4	1/4 NPT
29-S212F-0604	3/8	1/4 NPT
29-S212F-0606	3/8	3/8 NPT
29-S212F-0804	1/2	1/4 NPT
29-S212F-0806	1/2	3/8 NPT
29-S212F-0806	1/2	3/8 NPT
29-S212F-1212	3/4	3/4 NPT
29-S212F-1612	1"	3/4 NPT
29-S212F-1616	1"	1" NPT

Stainless Steel Twin Ferrule Compression Fittings (Category 29)

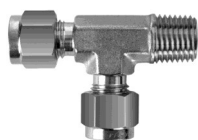

**#13SS
Male Run Tee**

Code	Tube	Male
29-S013-0402	1/4	1/8 BSPT
29-S013-0404	1/4	1/4 BSPT
29-S013-0506	5/16	3/8 BSPT
29-S013-0604	3/8	1/4 BSPT
29-S013-0606	3/8	3/8 BSPT
29-S013-0806	1/2	3/8 BSPT
29-S013-0808	1/2	1/2 BSPT
29-S213-0202	1/8	1/8 NPT
29-S213-0402	1/4	1/8 NPT
29-S213-0404	1/4	1/4 NPT
29-S213-0502	5/16	1/8 NPT
29-S213-0504	5/16	1/4 NPT
29-S213-0604	3/8	1/4 NPT
29-S213-0606	3/8	3/8 NPT
29-S213-0806	1/2	3/8 NPT
29-S213-0808	1/2	1/2 NPT
29-S213-1008	5/8	1/2 NPT
29-S213-1212	3/4	3/4 NPT
29-S313-1208	12mm	1/2 BSPT



**#14SS
Tee Tube
Union**

Code	Tube
29-S014-02	1/8
29-S014-03	3/16
29-S014-04	1/4
29-S014-05	5/16
29-S014-06	3/8
29-S014-08	1/2
29-S014-10	5/8
29-S014-12	3/4
29-S014-16	1"
29-S014-32	2"
29-S314-06	6mm
29-S314-10	10mm
29-S314-12	12mm

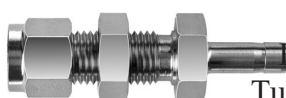

**#31ASS
Bulkhead
Tube Adaptor**

Code	Tube	Stem
29-S031A-04	1/4	1/4
29-S031A-08	1/2	1/2

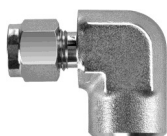

**#15SS
Female
Elbow**

Code	Tube	Female
29-S015-0302	3/16	1/8 BSPT
29-S015-0402	1/4	1/8 BSPT
29-S015-0404	1/4	1/4 BSPT
29-S015-0406	1/4	3/8 BSPT
29-S015-0408	1/4	1/2 BSPT
29-S015-0502	5/16	1/8 BSPT
29-S015-0504	5/16	1/4 BSPT
29-S015-0604	3/8	1/4 BSPT
29-S015-0606	3/8	3/8 BSPT
29-S015-0806	1/2	3/8 BSPT
29-S015-0808	1/2	1/2 BSPT
29-S015-1208	3/4	1/2 BSPT
29-S015-1212	3/4	3/4 BSPT
29-S015-1616	1"	1" BSPT
29-S215-0202	1/8	1/8 NPT
29-S215-0302	3/16	1/8 NPT
29-S215-0402	1/4	1/8 NPT
29-S215-0404	1/4	1/4 NPT
29-S215-0408	1/4	1/2 NPT
29-S215-0504	5/16	1/4 NPT
29-S215-0602	3/8	1/8 NPT
29-S215-0604	3/8	1/4 NPT
29-S215-0606	3/8	3/8 NPT
29-S215-0608	3/8	1/2 NPT
29-S215-0804	1/2	1/4 NPT
29-S215-0806	1/2	3/8 NPT
29-S215-0808	1/2	1/2 NPT
29-S215-1006	5/8	3/8 NPT
29-S215-1212	3/4	3/4 NPT
29-S215-1612	1"	3/4 NPT
29-S215-1616	1"	1" NPT



**#31SS
Bulkhead
Union**

Code	Tube
29-S031-02	1/8
29-S031-04	1/4
29-S031-05	5/16
29-S031-06	3/8
29-S031-08	1/2
29-S031-10	5/8
29-S031-12	3/4

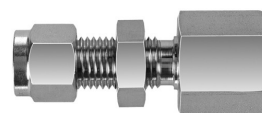

**#31FSS
Female
Bulkhead**

Code	Tube	Female
29-S031F-0402	1/4	1/8 BSPT
29-S031F-0404	1/4	1/4 BSPT
29-S031F-0604	3/8	1/4 BSPT
29-S031F-0808	1/2	1/2 BSPT
29-S231F-0402	1/4	1/8 NPT
29-S231F-0404	1/4	1/4 NPT
29-S231F-0604	3/8	1/4 NPT
29-S231F-0606	3/8	3/8 NPT
29-S231F-0806	1/2	3/8 NPT
29-S231F-0808	1/2	1/2 NPT

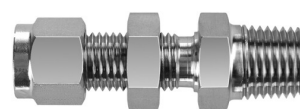

**#31MSS
Male
Bulkhead**

Code	Tube	Male
29-S031M-0402	1/4	1/8 BSPT
29-S031M-0404	1/4	1/4 BSPT
29-S031M-0604	3/8	1/4 BSPT
29-S031M-0606	3/8	3/8 BSPT
29-S031M-0806	1/2	3/8 BSPT
29-S031M-0808	1/2	1/2 BSPT
29-S231M-0402	1/4	1/8 NPT
29-S231M-0404	1/4	1/4 NPT
29-S231M-0604	3/8	1/4 NPT
29-S231M-0606	3/8	3/8 NPT
29-S231M-0806	1/2	3/8 NPT
29-S231M-0808	1/2	1/2 NPT

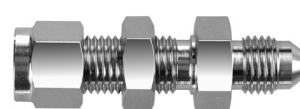

**#31MSS
JIC Male
Bulkhead**

Code	Tube	Male
29-S631M-0604	3/8	7/16 JIC
29-S631M-0606	3/8	9/16 JIC

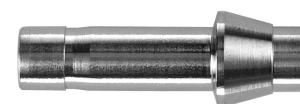

**#44SS
Port
Connector**

Code	Tube
29-S044-02	1/8
29-S044-04	1/4
29-S044-06	3/8
29-S044-08	1/2
29-S044-16	1"

Stainless Steel Twin Ferrule Compression Fittings (Category 29)



#56SS
Tube Plug

Code	Tube
29-S056-01	1/16
29-S056-02	1/8
29-S056-03	3/16
29-S056-04	1/4
29-S056-05	5/16
29-S056-06	3/8
29-S056-08	1/2
29-S056-12	3/4
29-S056-16	1"

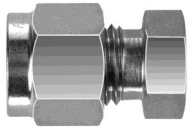

#65SS
Tube Cap

Code	Tube
29-S065-02	1/8
29-S065-03	3/16
29-S065-04	1/4
29-S065-05	5/16
29-S065-06	3/8
29-S065-08	1/2
29-S065-10	5/8
29-S065-12	3/4
29-S065-16	1"
29-S365-16	16mm



#72ASS
Reducing Tube
Adaptor

Code	Stem	Tube
29-S072A-0102	1/16	1/8
29-S072A-0201	1/8	1/16
29-S072A-0204	1/8	1/4
29-S072A-0304	3/16	1/4
29-S072A-0401	1/4	1/16
29-S072A-0402	1/4	1/8
29-S072A-0406	1/4	3/8
29-S072A-0408	1/4	1/2
29-S072A-0504	5/16	1/4
29-S072A-0604	3/8	1/4
29-S072A-0605	3/8	5/16
29-S072A-0608	3/8	1/2
29-S072A-0804	1/2	1/4
29-S072A-0805	1/2	5/16
29-S072A-0806	1/2	3/8
29-S072A-0812	1/2	3/4
29-S072A-1206	3/4	3/8
29-S072A-1208	3/4	1/2
29-S072A-1216	3/4	1"
29-S072A-1608	1"	1/2
29-S072A-1612	1"	3/4



#44RSS
Reducing Port
Connector

Code	Tube	Stem
29-S044R-0604	3/8	1/4
29-S044R-0804	1/2	1/4
29-S044R-0806	1/2	3/8



#68SS
Union Cross

Code	Tube
29-S068-02	1/8
29-S068-04	1/4
29-S068-05	5/16
29-S068-06	3/8
29-S068-08	1/2
29-S068-10	5/8
29-S068-12	3/4
29-S068-16	1"

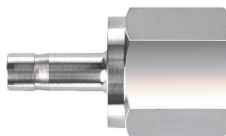

#72FSS
Female Tube
Adaptor

Code	Stem	Female
29-S072F-0402	1/4	1/8 BSPT
29-S072F-0404	1/4	1/4 BSPT
29-S072F-0406	1/4	3/8 BSPT
29-S072F-0408	1/4	1/2 BSPT
29-S072F-0604	3/8	1/4 BSPT
29-S072F-0606	3/8	3/8 BSPT
29-S072F-0608	3/8	1/2 BSPT
29-S072F-0806	1/2	3/8 BSPT
29-S072F-0808	1/2	1/2 BSPT
29-S272F-0204	1/8	1/4 NPT
29-S272F-0402	1/4	1/8 NPT
29-S272F-0404	1/4	1/4 NPT
29-S272F-0406	1/4	3/8 NPT
29-S272F-0408	1/4	1/2 NPT
29-S272F-0504	5/16	1/4 NPT
29-S272F-0602	3/8	1/8 NPT
29-S272F-0604	3/8	1/4 NPT
29-S272F-0606	3/8	3/8 NPT
29-S272F-0608	3/8	1/2 NPT
29-S272F-0804	1/2	1/4 NPT
29-S272F-0806	1/2	3/8 NPT
29-S272F-0808	1/2	1/2 NPT
29-S272F-1208	3/4	1/2 NPT
29-S272F-1212	3/4	3/4 NPT
29-S272F-1216	3/4	1" NPT
29-S272F-1612	1"	3/4 NPT
29-S272F-1616	1"	1" NPT



#72SS
Male Tube
Adaptor

Code	Stem	Male
29-S072M-0402	1/4	1/8 BSPT
29-S072M-0404	1/4	1/4 BSPT
29-S072M-0406	1/4	3/8 BSPT
29-S072M-0408	1/4	1/2 BSPT
29-S072M-0504	5/16	1/4 BSPT
29-S072M-0602	3/8	1/8 BSPT
29-S072M-0604	3/8	1/4 BSPT
29-S072M-0606	3/8	3/8 BSPT
29-S072M-0608	3/8	1/2 BSPT
29-S072M-0804	1/2	1/4 BSPT
29-S072M-0806	1/2	3/8 BSPT
29-S072M-0808	1/2	1/2 BSPT
29-S072M-1208	3/4	1/2 BSPT
29-S072M-1212	3/4	3/4 BSPT
29-S072M-1612	1"	3/4 BSPT
29-S072M-1616	1"	1" BSPT
29-S272M-0202	1/8	1/8 NPT
29-S272M-0204	1/8	1/4 NPT
29-S272M-0402	1/4	1/8 NPT
29-S272M-0404	1/4	1/4 NPT
29-S272M-0406	1/4	3/8 NPT
29-S272M-0408	1/4	1/2 NPT
29-S272M-0602	3/8	1/8 NPT
29-S272M-0604	3/8	1/4 NPT
29-S272M-0606	3/8	3/8 NPT
29-S272M-0608	3/8	1/2 NPT
29-S272M-0806	1/2	3/8 NPT
29-S272M-0808	1/2	1/2 NPT
29-S272M-0812	1/2	3/4 NPT
29-S272M-1208	3/4	1/2 NPT
29-S272M-1212	3/4	3/4 NPT
29-S272M-1216	3/4	1" NPT
29-S272M-1612	1"	3/4 NPT
29-S272M-1616	1"	1" NPT
29-S272M-2020	1.1/4	1.1/4 NPT

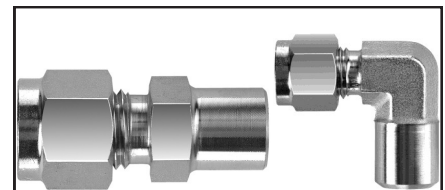

Some sizes of Socket Weld and Pipe Weld fittings also available in straight and elbows. Please contact the sales office for further information

Stainless Steel Screwed Fittings - 150lb Class. (Category 31)



#24SS
Reducing
Bush

Code	Male	Female
31-024-0402	1/4 BSPT	1/8 BSP
31-024-0602	3/8 BSPT	1/8 BSP
31-024-0604	3/8 BSPT	1/4 BSP
31-024-0802	1/2 BSPT	1/8 BSP
31-024-0804	1/2 BSPT	1/4 BSP
31-024-0806	1/2 BSPT	3/8 BSP
31-024-1204	3/4 BSPT	1/4 BSP
31-024-1206	3/4 BSPT	3/8 BSP
31-024-1208	3/4 BSPT	1/2 BSP
31-024-1608	1" BSPT	1/2 BSP
31-024-1612	1" BSPT	3/4 BSP
31-024-2008	1.1/4 BSPT	1/2 BSP
31-024-2012	1.1/4 BSPT	3/4 BSP
31-024-2016	1.1/4 BSPT	1" BSP
31-024-2408	1.1/2 BSPT	1/2 BSP
31-024-2412	1.1/2 BSPT	3/4 BSP
31-024-2416	1.1/2 BSPT	1" BSP
31-024-2420	1.1/2 BSPT	1.1/4 BSP
31-024-3212	2" BSPT	3/4 BSP
31-024-3216	2" BSPT	1" BSP
31-024-3220	2" BSPT	1.1/4 BSP
31-024-3224	2" BSPT	1.1/2 BSP
31-024-4032	2.1/2 BSPT	2" BSP
31-024-4832	3" BSPT	2" BSP
31-024-4840	3" BSPT	2.1/2 BSP
31-024-6432	4" BSPT	2" BSP
31-024-6448	4" BSPT	3" BSP



#24SSFBH
Female
Bulkhead

Code	Female	Male
31-024FBH-02	1/8 BSP	M16x1.5
31-024FBH-04	1/4 BSP	M20x1.5
31-024FBH-06	3/8 BSP	M26x1.5
31-024FBH-08	1/2 BSP	M28x1.5
31-024FBH-12	3/4 BSP	M34x1.5

NPT Screwed 150lb Stainless Steel Fittings are available in some sizes. Please contact the office for any enquiries.

#25SS
M&F
Elbow



Code	Male	Female
31-025-02	1/8 BSPT	1/8 BSP
31-025-04	1/4 BSPT	1/4 BSP
31-025-06	3/8 BSPT	3/8 BSP
31-025-08	1/2 BSPT	1/2 BSP
31-025-12	3/4 BSPT	3/4 BSP
31-025-16	1" BSPT	1" BSP
31-025-20	1.1/4 BSPT	1.1/4 BSP
31-025-24	1.1/2 BSPT	1.1/2 BSP
31-025-32	2" BSPT	2" BSP
31-025-40	2.1/2 BSPT	2.1/2 BSP
31-025-48	3" BSPT	3" BSP
31-025-64	4" BSPT	4" BSP

#25DSS
45° M&F
Elbow



Code	Male	Female
31-025D-02	1/8 BSPT	1/8 BSP
31-025D-04	1/4 BSPT	1/4 BSP
31-025D-06	3/8 BSPT	3/8 BSP
31-025D-08	1/2 BSPT	1/2 BSP
31-025D-12	3/4 BSPT	3/4 BSP
31-025D-16	1" BSPT	1" BSP
31-025D-20	1.1/4 BSPT	1.1/4 BSP
31-025D-24	1.1/2 BSPT	1.1/2 BSP
31-025D-32	2" BSPT	2" BSP

#26SS
Round
Socket



Code	Female
31-026-02	1/8 BSP
31-026-04	1/4 BSP
31-026-06	3/8 BSP
31-026-08	1/2 BSP
31-026-12	3/4 BSP
31-026-16	1" BSP
31-026-20	1.1/4 BSP
31-026-24	1.1/2 BSP
31-026-32	2" BSP
31-026-40	2.1/2 BSP
31-026-48	3" BSP
31-026-64	4" BSP

#26HSS
Half
Socket



Code	Female
31-026H-08	1/2 BSP
31-026H-12	3/4 BSP
31-026H-16	1" BSP
31-026H-20	1.1/4 BSP
31-026H-24	1.1/2 BSP
31-026H-32	2" BSP
31-026H-40	2.1/2 BSP
31-026H-48	3" BSP

#27SS
Hex
Nipple



Code	Male
31-027-02	1/8 BSPT
31-027-04	1/4 BSPT
31-027-06	3/8 BSPT
31-027-08	1/2 BSPT
31-027-12	3/4 BSPT
31-027-16	1" BSPT
31-027-20	1.1/4 BSPT
31-027-24	1.1/2 BSPT
31-027-32	2" BSPT
31-027-40	2.1/2 BSPT
31-027-48	3" BSPT
31-027-64	4" BSPT

Some sizes of BSPT / NPT nipples also available. Please contact the sales office for details

#27BSS
Butt (Barrell)
Nipple



Code	Male
31-027B-02	1/8 BSPT
31-027B-04	1/4 BSPT
31-027B-06	3/8 BSPT
31-027B-08	1/2 BSPT
31-027B-12	3/4 BSPT
31-027B-16	1" BSPT
31-027B-20	1.1/4 BSPT
31-027B-24	1.1/2 BSPT
31-027B-32	2" BSPT
31-027B-40	2.1/2 BSPT
31-027B-48	3" BSPT
31-027B-64	4" BSPT

Some sizes available longer than standard. Please contact the sales office for your requirements.

Stainless Steel Screwed Fittings - 150lb Class. (Category 31)

#29SS
Reducing
Socket



Code	Female	Female
31-029-0402	1/4 BSP	1/8 BSP
31-029-0602	3/8 BSP	1/8 BSP
31-029-0604	3/8 BSP	1/4 BSP
31-029-0802	1/2 BSP	1/8 BSP
31-029-0804	1/2 BSP	1/4 BSP
31-029-0806	1/2 BSP	3/8 BSP
31-029-1204	3/4 BSP	1/4 BSP
31-029-1206	3/4 BSP	3/8 BSP
31-029-1208	3/4 BSP	1/2 BSP
31-029-1608	1" BSP	1/2 BSP
31-029-1612	1" BSP	3/4 BSP
31-029-2416	1.1/2 BSP	1" BSP
31-029-2420	1.1/2 BSP	1.1/4 BSP
31-029-3224	2" BSP	1.1/2 BSP

#34DSS
45° Female
Elbow



Code	Female
31-034D-02	1/8 BSP
31-034D-04	1/4 BSP
31-034D-06	3/8 BSP
31-034D-08	1/2 BSP
31-034D-12	3/4 BSP
31-034D-16	1" BSP
31-034D-20	1.1/4 BSP
31-034D-24	1.1/2 BSP
31-034D-32	2" BSP
31-034D-48	3" BSP

#64SS
Hex
Plug



Code	Male
31-064-02	1/8 BSPT
31-064-04	1/4 BSPT
31-064-06	3/8 BSPT
31-064-08	1/2 BSPT
31-064-12	3/4 BSPT
31-064-16	1" BSPT
31-064-20	1.1/4 BSPT
31-064-24	1.1/2 BSPT
31-064-32	2" BSPT
31-064-40	2.1/2 BSPT
31-064-48	3" BSPT
31-064-64	4" BSPT

#33SS
Hex
Cap



Code	Female
31-033-02	1/8 BSP
31-033-04	1/4 BSP
31-033-06	3/8 BSP
31-033-08	1/2 BSP
31-033-12	3/4 BSP
31-033-16	1" BSP
31-033-20	1.1/4 BSP
31-033-24	1.1/2 BSP
31-033-32	2" BSP
31-033-40	2.1/2 BSP
31-033-48	3" BSP
31-033-64	4" BSP

#35SS
Female
Tee



Code	Female
31-035-02	1/8 BSP
31-035-04	1/4 BSP
31-035-06	3/8 BSP
31-035-08	1/2 BSP
31-035-12	3/4 BSP
31-035-16	1" BSP
31-035-20	1.1/4 BSP
31-035-24	1.1/2 BSP
31-035-32	2" BSP
31-035-40	2.1/2 BSP
31-035-48	3" BSP
31-035-64	4" BSP

#72SS
M&F
Adaptor

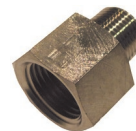

Code	Female	Male
31-072-0202	1/8 BSP	1/8 BSPT
31-072-02M06	1/8 BSP	M6x1
31-072-02U04	1/8 BSP	1/4 UNF
31-072-0402	1/4 BSP	1/8 BSPT
31-072-0404	1/4 BSP	1/4 BSPT
31-072-04M06	1/4 BSP	M6x1
31-072-04U04	1/4 BSP	1/4 UNF
31-072-0602	3/8 BSP	1/8 BSPT
31-072-0604	3/8 BSP	1/4 BSPT
31-072-0606	3/8 BSP	3/8 BSPT
31-072-0804	1/2 BSP	1/4 BSPT
31-072-0806	1/2 BSP	3/8 BSPT
31-072-0808	1/2 BSP	1/2 BSPT
31-072-1208	3/4 BSP	1/2 BSPT
31-072-1212	3/4 BSP	3/4 BSPT
31-072-1608	1" BSP	1/2 BSPT
31-072-1612	1" BSP	3/4 BSPT
31-072-N0404	1/4 NPT	1/4 BSPT

#34SS
Female
Elbow



Code	Female
31-034-02	1/8 BSP
31-034-04	1/4 BSP
31-034-06	3/8 BSP
31-034-08	1/2 BSP
31-034-12	3/4 BSP
31-034-16	1" BSP
31-034-20	1.1/4 BSP
31-034-24	1.1/2 BSP
31-034-32	2" BSP
31-034-40	2.1/2 BSP
31-034-48	3" BSP
31-034-64	4" BSP

#37SS
Female
Cross



Code	Female
31-037-02	1/8 BSP
31-037-04	1/4 BSP
31-037-06	3/8 BSP
31-037-08	1/2 BSP
31-037-12	3/4 BSP
31-037-16	1" BSP
31-037-20	1.1/4 BSP
31-037-24	1.1/2 BSP
31-037-32	2" BSP

#72LSS
Long M&F
Adaptor



Code	Thread	Length
31-072-020224	1/8 BSPT	1.1/2

Stainless Steel Screwed Fittings - 150lb Class. (Category 31)

#73SS
Reducing
Hex Nipple



Code	Male	Male
31-073-0402	1/4 BSPT	1/8 BSPT
31-073-0602	3/8 BSPT	1/8 BSPT
31-073-0604	3/8 BSPT	1/4 BSPT
31-073-0802	1/2 BSPT	1/8 BSPT
31-073-0804	1/2 BSPT	1/4 BSPT
31-073-0806	1/2 BSPT	3/8 BSPT
31-073-1204	3/4 BSPT	1/4 BSPT
31-073-1206	3/4 BSPT	3/8 BSPT
31-073-1208	3/4 BSPT	1/2 BSPT
31-073-1608	1" BSPT	1/2 BSPT
31-073-1612	1" BSPT	3/4 BSPT
31-073-2012	1.1/4 BSPT	3/4 BSPT
31-073-2016	1.1/4 BSPT	1" BSPT
31-073-2412	1.1/2 BSPT	3/4 BSPT
31-073-2416	1.1/2 BSPT	1" BSPT
31-073-2420	1.1/2 BSPT	1.1/4 BSPT
31-073-3212	2" BSPT	3/4 BSPT
31-073-3216	2" BSPT	1" BSPT
31-073-3220	2" BSPT	1.1/4 BSPT
31-073-3224	2" BSPT	1.1/2 BSPT
31-073-4032	2.1/2 BSPT	2" BSPT
31-073-4832	3" BSPT	2" BSPT
31-073-4840	3" BSPT	2.1/2 BSPT
31-073-6432	4" BSPT	2" BSPT
31-073-6448	4" BSPT	3" BSPT

#74SS
Hex
Locknut



Code	Female
31-074-02	1/8 BSP
31-074-04	1/4 BSP
31-074-06	3/8 BSP
31-074-08	1/2 BSP
31-074-12	3/4 BSP
31-074-16	1" BSP
31-074-20	1.1/4 BSP
31-074-24	1.1/2 BSP
31-074-32	2" BSP
31-074-40	2.1/2 BSP
31-074-48	3" BSP
31-074-64	4" BSP

#85SS
F&F
Barrell Union



Code	Female
31-085-02	1/8 BSP
31-085-04	1/4 BSP
31-085-06	3/8 BSP
31-085-08	1/2 BSP
31-085-12	3/4 BSP
31-085-16	1" BSP
31-085-20	1.1/4 BSP
31-085-24	1.1/2 BSP
31-085-32	2" BSP
31-085-40	2.1/2 BSP
31-085-48	3" BSP
31-085-64	4" BSP

#87SS
M&F
Barrell Union



Code	Male	Female
31-087-04	1/4 BSPT	1/4 BSP
31-087-06	3/8 BSPT	3/8 BSP
31-087-08	1/2 BSPT	1/2 BSP
31-087-12	3/4 BSPT	3/4 BSP
31-087-16	1" BSPT	1" BSP
31-087-20	1.1/4 BSPT	1.1/4 BSP
31-087-24	1.1/2 BSPT	1.1/2 BSP
31-087-32	2" BSPT	2" BSP

#88SS
Toe
Nipple



Code	Male
31-088-02	1/8 BSPT
31-088-04	1/4 BSPT
31-088-06	3/8 BSPT
31-088-08	1/2 BSPT
31-088-12	3/4 BSPT
31-088-16	1" BSPT
31-088-20	1.1/4 BSPT
31-088-24	1.1/2 BSPT
31-088-32	2" BSPT
31-088-40	2.1/2 BSPT
31-088-48	3" BSPT
31-088-64	4" BSPT

Some sizes available longer than standard. Please contact the sales office for your requirements.

Stainless
Steel
Allthread



Code	Male	Length
31-AT0812	1/2 BSP	12" - 300 mm
31-AT1212	3/4 BSP	12" - 300 mm
31-AT1612	1" BSP	12" - 300 mm
31-AT2012	1.1/4 BSP	12" - 300 mm
31-AT2412	1.1/2 BSP	12" - 300 mm
31-AT3212	2" BSP	12" - 300 mm
31-AT4012	2.1/2 BSP	12" - 300 mm
31-AT4812	3" BSP	12" - 300 mm
31-AT6412	4" BSP	12" - 300 mm

Stainless
Steel Skin
Fitting



Code	Male
31-SK08	1/2 BSP
31-SK12	3/4 BSP
31-SK16	1" BSP
31-SK20	1.1/4 BSP
31-SK24	1.1/2 BSP
31-SK32	2" BSP
31-SK40	2.1/2 BSP
31-SK48	3" BSP
31-SK64	4" BSP

SFSS
Flat Silencer



Code	Male
31-SF02	1/8 BSP
31-SF04	1/4 BSP
31-SF06	3/8 BSP
31-SF08	1/2 BSP

SMSS
Medium
Silencer



Code	Male
31-SM02	1/8 BSP
31-SM04	1/4 BSP
31-SM06	3/8 BSP
31-SM08	1/2 BSP

Stainless Steel Hosetails - 150lb Class. (Category 31)

P3SS
Male
Hosetail



Code	Hose	Male
31-SSP.30402	1/4	1/8 BSPT
31-SSP.30404	1/4	1/4 BSPT
31-SSP.30502	5/16	1/8 BSPT
31-SSP.30504	5/16	1/4 BSPT
31-SSP.30604	3/8	1/4 BSPT
31-SSP.30606	3/8	3/8 BSPT
31-SSP.30608	3/8	1/2 BSPT
31-SSP.30612	3/8	3/4 BSPT
31-SSP.30802	1/2	1/8 BSPT
31-SSP.30804	1/2	1/4 BSPT
31-SSP.30806	1/2	3/8 BSPT
31-SSP.30808	1/2	1/2 BSPT
31-SSP.30812	1/2	3/4 BSPT
31-SSP.30816	1/2	1" BSPT
31-SSP.31008	5/8	1/2 BSPT
31-SSP.31208	3/4	1/2 BSPT
31-SSP.31212	3/4	3/4 BSPT
31-SSP.31216	3/4	1" BSPT
31-SSP.31608	1"	1/2 BSPT
31-SSP.31612	1"	3/4 BSPT
31-SSP.31616	1"	1" BSPT
31-SSP.31620	1"	1.1/4 BSPT
31-SSP.31624	1"	1.1/2 BSPT
31-SSP.31632	1"	2" BSPT
31-SSP.32016	1.1/4	1" BSPT
31-SSP.32020	1.1/4	1.1/4 BSPT
31-SSP.32024	1.1/4	1.1/2 BSPT
31-SSP.32032	1.1/4	2" BSPT
31-SSP.32416	1.1/2	1" BSPT
31-SSP.32420	1.1/2	1.1/4 BSPT
31-SSP.32424	1.1/2	1.1/2 BSPT
31-SSP.32432	1.1/2	2" BSPT
31-SSP.33216	2"	1" BSPT
31-SSP.33220	2"	1.1/4 BSPT
31-SSP.33224	2"	1.1/2 BSPT
31-SSP.33232	2"	2" BSPT
31-SSP.33240	2"	2.1/2 BSPT
31-SSP.33248	2"	3" BSPT
31-SSP.34040	2.1/2	2.1/2 BSPT
31-SSP.34048	2.1/2	3" BSPT
31-SSP.34848	3"	3" BSPT
31-SSP.34864	3"	4" BSPT
31-SSP.36464	4"	4" BSPT

P7SS
Hosetail
Joiner



Code	Hose
31-SSP.704	1/4
31-SSP.706	3/8
31-SSP.708	1/2
31-SSP.712	3/4
31-SSP.716	1"
31-SSP.720	1.1/4
31-SSP.724	1.1/2
31-SSP.732	2"

P14SS
Hosetail
Tee



Code	Hose
31-SSP1404	1/4
31-SSP1406	3/8
31-SSP1408	1/2

P25SS
Nut & Tail
Flat Seat



Code	Hose	Female
31-SSP250504	5/16	1/4 BSP
31-SSP250606	3/8	3/8 BSP
31-SSP250808	1/2	1/2 BSP
31-SSP251212	3/4	3/4 BSP
31-SSP251616	1"	1" BSP
31-SSP252020	1.1/4	1.1/4 BSP
31-SSP252424	1.1/2	1.1/2 BSP
31-SSP253232	2"	2" BSP

P75SS
Hosetail
Y-Piece



Code	Hose
31-SSP7508	1/2

ALSO AVAILABLE

SUPERLOK® INSTRUMENTATION FITTINGS



STANDARD BRASS - Standard Metric Comp Fittings. (Category 32)

TUBE: Copper, Aluminium, Bundy, Nylon (with spigot for high pressure).

PRESSURE: Medium pressure ratings around 3500kpa/500psi decreasing as tube sizes increase and depending on the medium.

TEMPERATURE: 0°C to 120°C

TYPICAL USES: Airlines, Oil/Petrol lines, water lines.

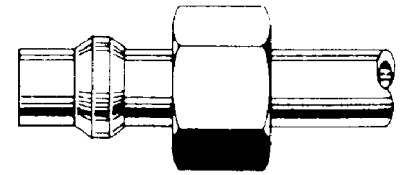
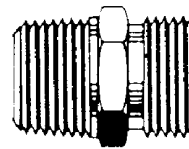

M100
Universal
Olive

Code	Tube
32-M.10004	4mm
32-M.10005	5mm
32-M.10006	6mm
32-M.10008	8mm
32-M.10010	10mm
32-M.10012	12mm
32-M.10014	14mm
32-M.10015	15mm
32-M.10016	16mm
32-M.10018	18mm
32-M.10020	20mm



M1
Metallic Tube
Olive

Code	Tube
32-M.104	4mm
32-M.105	5mm
32-M.106	6mm
32-M.108	8mm
32-M.110	10mm
32-M.112	12mm
32-M.114	14mm
32-M.115	15mm
32-M.116	16mm



M2
Tube
Nut

Code	Tube	Thread
32-M.204	4mm	M8x1
32-M.205	5mm	M10x1
32-M.206	6mm	M10x1
32-M.208	8mm	M12x1
32-M.210	10mm	M16x1.5
32-M.212	12mm	M18x1.5
32-M.214	14mm	M20x1.5
32-M.215	15mm	M20x1.5
32-M.216	16mm	M22x1.5
32-M.218	18mm	M24x1.5
32-M.220	20mm	M27x1.5



M3
Male
Connector

Code	Tube	Thread
32-M.30402	4mm	1/8 BSPT
32-M.304M06	4mm	M6x1
32-M.30502	5mm	1/8 BSPT
32-M.30504	5mm	1/4 BSPT
32-M.30602	6mm	1/8 BSPT
32-M.30604	6mm	1/4 BSPT
32-M.30606	6mm	3/8 BSPT
32-M.306M06	6mm	M6x1
32-M.306M10C	6mm	M10x1
32-M.30802	8mm	1/8 BSPT
32-M.30804	8mm	1/4 BSPT
32-M.30806	8mm	3/8 BSPT
32-M.30808	8mm	1/2 BSPT
32-M.31002	10mm	1/8 BSPT
32-M.31004	10mm	1/4 BSPT
32-M.31006	10mm	3/8 BSPT
32-M.31008	10mm	1/2 BSPT
32-M.31204	12mm	1/4 BSPT
32-M.31206	12mm	3/8 BSPT
32-M.31208	12mm	1/2 BSPT
32-M.31404	14mm	1/4 BSPT
32-M.31406	14mm	3/8 BSPT
32-M.31408	14mm	1/2 BSPT
32-M.31506	15mm	3/8 BSPT
32-M.31508	15mm	1/2 BSPT
32-M.31606	16mm	3/8 BSPT
32-M.31608	16mm	1/2 BSPT
32-M.31612	16mm	3/4 BSPT
32-M.32008	20mm	1/2 BSPT
32-M.32208	22mm	1/2 BSPT



M3P
BSPP Male
Connector

Some sizes available with parallel threads. Please contact the sales office for further information.



M4
Double
Union

Code	Tube
32-M.404	4mm
32-M.405	5mm
32-M.406	6mm
32-M.408	8mm
32-M.410	10mm
32-M.412	12mm
32-M.414	14mm
32-M.415	15mm
32-M.416	16mm

Some reducing unions also available. Please contact the sales office for further information.



M5
Male Elbow
Connector

Code	Tube	Thread
32-M.50402	4mm	1/8 BSPT
32-M.50404	4mm	1/4 BSPT
32-M.504M06	4mm	M6x1
32-M.50502	5mm	1/8 BSPT
32-M.50504	5mm	1/4 BSPT
32-M.50602	6mm	1/8 BSPT
32-M.50604	6mm	1/4 BSPT
32-M.506M06	6mm	M6x1
32-M.50802	8mm	1/8 BSPT
32-M.50804	8mm	1/4 BSPT
32-M.50806	8mm	3/8 BSPT
32-M.51004	10mm	1/4 BSPT
32-M.51006	10mm	3/8 BSPT
32-M.51008	10mm	1/2 BSPT
32-M.51204	12mm	1/4 BSPT
32-M.51206	12mm	3/8 BSPT
32-M.51208	12mm	1/2 BSPT
32-M.51406	14mm	3/8 BSPT
32-M.51408	14mm	1/2 BSPT
32-M.51506	15mm	3/8 BSPT
32-M.51508	15mm	1/2 BSPT
32-M.51606	16mm	3/8 BSPT
32-M.51608	16mm	1/2 BSPT

STANDARD BRASS - Standard Metric Comp Fittings. (Category 32)



M6
Banjo Male
Elbow



M6D
Double Banjo
Male Elbow

Some sizes available in Banjo Fittings. Please contact the sales office for further information.



M10
Female
Connector

Code	Tube	Thread
32-M100402	4mm	1/8 BSP
32-M100404	4mm	1/4 BSP
32-M100502	5mm	1/8 BSP
32-M100504	5mm	1/4 BSP
32-M100602	6mm	1/8 BSP
32-M100604	6mm	1/4 BSP
32-M100606	6mm	3/8 BSP
32-M100802	8mm	1/8 BSP
32-M100804	8mm	1/4 BSP
32-M100806	8mm	3/8 BSP
32-M101004	10mm	1/4 BSP
32-M101006	10mm	3/8 BSP
32-M101008	10mm	1/2 BSP
32-M101204	12mm	1/4 BSP
32-M101206	12mm	3/8 BSP
32-M101208	12mm	1/2 BSP
32-M101404	14mm	1/4 BSP
32-M101406	14mm	3/8 BSP
32-M101408	14mm	1/2 BSP
32-M101508	15mm	1/2 BSP
32-M101608	16mm	1/2 BSP

NOTE : Compression Fittings are fitted with the M100 olive as standard. Please contact the office if there is a requirement for an alternative olive.



M11
Elbow
Union

Code	Tube
32-M1104	4mm
32-M1105	5mm
32-M1106	6mm
32-M1108	8mm
32-M1110	10mm
32-M1112	12mm
32-M1114	14mm
32-M1115	15mm

Some reducing elbows also available. Please contact the sales office for further information.



M12
Male
Branch Tee

Code	Tube	Thread
32-M120402	4mm	1/8 BSPT
32-M120502	5mm	1/8 BSPT
32-M120602	6mm	1/8 BSPT
32-M120604	6mm	1/4 BSPT
32-M120802	8mm	1/8 BSPT
32-M120804	8mm	1/4 BSPT
32-M120806	8mm	3/8 BSPT
32-M121004	10mm	1/4 BSPT
32-M121006	10mm	3/8 BSPT
32-M121204	12mm	1/4 BSPT
32-M121206	12mm	3/8 BSPT
32-M121406	14mm	3/8 BSPT
32-M121408	14mm	1/2 BSPT
32-M121506	15mm	3/8 BSPT

Our range of metric compression fittings is constantly expanding. Please contact the office if you have a requirement that is not shown in the catalogue



M13
Male
Run Tee

Code	Tube	Thread
32-M130402	4mm	1/8 BSPT
32-M130502	5mm	1/8 BSPT
32-M130602	6mm	1/8 BSPT
32-M130604	6mm	1/4 BSPT
32-M130802	8mm	1/8 BSPT
32-M130804	8mm	1/4 BSPT
32-M130806	8mm	3/8 BSPT
32-M131004	10mm	1/4 BSPT
32-M131006	10mm	3/8 BSPT
32-M131204	12mm	1/4 BSPT
32-M131206	12mm	3/8 BSPT
32-M131406	14mm	3/8 BSPT
32-M131408	14mm	1/2 BSPT



M14
Tee
Union

Code	Tube
32-M1404	4mm
32-M1405	5mm
32-M1406	6mm
32-M1408	8mm
32-M1410	10mm
32-M1412	12mm
32-M1414	14mm
32-M1415	15mm



M14R
Reducing
Tee Union

Some reducing tees also available. Please contact the sales office for further information.

Do you need a thread sealant? We stock various types of thread tape and a full range of Bondloc thread lockers and sealants.



STANDARD BRASS - Standard Metric Comp Fittings. (Category 32)



M31
Bulkhead
Union

Code	Tube
32-M3104	4mm
32-M3105	5mm
32-M3106	6mm
32-M3108	8mm
32-M3110	10mm
32-M3112	12mm
32-M3114	14mm



M68
Union
Cross

Some sizes available. Please contact the sales office for further information.



M72A
Reduction
Assembly

Code	Tube	Tube
32-M72A0604	6mm	4mm
32-M72A-0804	8mm	4mm
32-M72A-0806	8mm	6mm
32-M72A-1006	10mm	6mm
32-M72A-1206	12mm	6mm
32-M72A-1208	12mm	8mm



M75
Union
Y Piece

Some sizes available. Please contact the sales office for further information.



M99 Spigot For
250psi Flexible
Nylon Metric Tube

Code	Tube
32-M9904	4mm
32-M9905	5mm
32-M9906	6mm
32-M9908	8mm
32-M9910	10mm
32-M9912	12mm

Other Products Available

- Brass Screwed Fittings in BSP, NPT and other threads
- Brass Internal Compression Fittings
- Stainless Steel Compression Fittings
- Acetal Compression Fittings
- Brass SAE Flare Fittings
- Brass Inverted Flare fittings
- Stainless Steel Hydraulic Fittings
- Brass and Copper Capillary Fittings
- NTA , Westinghouse and PBR Style Airbrake Fittings
- Pneumatic Push-In Fittings
- Nickel Plated Brass Push-In Fittings
- All Plastic Push-In Fittings
- Stainless Steel Push-In Fittings
- D.O.T. Approved Push-In Fittings
- Barbed Airline Fittings
- Quick Disconnect Couplers - Nitto, Ryco, Jamec, Inteva, Tefen and many more.
- Automotive, LPG and Oxy/Acetylene Fittings
- Camlocks and Claw Couplers
- Ball, Needle, Check and Gate Valves
- Pressure and Vacuum Gauges
- Nylon, LDPE and Polyurethane Tube
- Copper, Bundy and Stainless Tube
- Tube Cutters and Flaring Tools
- PVC and Rubber Hose
- Retractable and Manual Hose Reels
- Multi Stala Storage Systems
- Filter Regulators and Lubricators
- Grease Nipples and Lubrication Equipment
- Hose Clamps in many styles
- Cable Ties and Plastic Spiral Wrap
- Thread Sealants and Teflon Tape.



INDUSTRIAL FITTINGS SALES
(VIC) Pty. Ltd. ABN 12 051 387 029



16-18 Smeaton Avenue, Dandenong South. Victoria 3175
Phone (03) 8770 1333 Fax (03) 8770 1313
Email : sales@ifsvic.com.au

Airbrake Couplers & Adapters (Category 33)



Female Threaded Coupler

Code	Female	Sealing
33-A33	1/4 NPS	Yes
33-A34	3/8 NPS	Yes
33-A35	1/2 NPS	Yes
33-A86	1/4 NPS	No
33-A82	3/8 NPS	No
33-A87	1/2 NPS	No



Male Threaded Coupler

Code	Male	Sealing
33-A30	1/4 NPT	Yes
33-A31	3/8 NPT	Yes
33-A32	1/2 NPT	Yes
33-A83	1/4 NPT	No
33-A84	3/8 NPT	No
33-A85	1/2 NPT	No

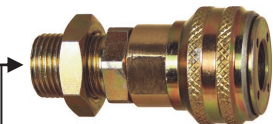

Bulkhead Coupler

Takes 3/8 Nylon Tube with NF104-6 and NF103-6 or 6R Nut and Ferrule

Code	Male	Sealing
33-A117	1/2 BSPP	Yes
33-A112	1/2 BSPP	No



Road Train Coupler

Code	Male	Port	Sealing
33-A118	1/2 BSPP	1/8 NPS	Yes



Coupler Repair Kit

Code : 33-QRK1

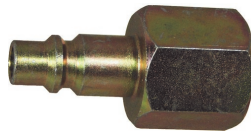

Female Non-Sealing Adapter

Code	Female
33-A21	1/4 NPS
33-A22	3/8 NPS
33-A23	1/2 NPS

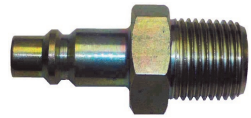

Male Non-Sealing Adapter

Code	Male
33-A18	1/4 NPS
33-A18B	1/4 BSPT
33-A19	3/8 NPS
33-A20	1/2 NPS



Barbed Non-Sealing Adapter

Code	Hose
33-A29	1/4
33-A13	5/16
33-A08	3/8
33-A14	1/2

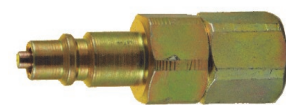

Female Sealing Adapter

Code	Female
33-A88	1/4 NPS
33-A89	3/8 NPS
33-A90	1/2 NPS

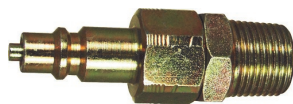

Male Sealing Adapter

Code	Male
33-A91	1/4 NPT
33-A92	3/8 NPT
33-A93	1/2 NPT

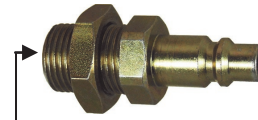

Bulkhead Adaptor

Takes 3/8 Nylon Tube with NF104-6 and NF103-6 or 6R Nut and Ferrule

Code	Male	Sealing
33-A110	1/2 BSPP	Yes
33-A109	1/2 BSPP	No



Coupler Dust Plug & Chain

Code : 33-A79



Adapter Dust Cover & Chain

Code : 33-A81



Dead End Female for Adapters

Code : 33-A97



Dead End Male for Couplers

Code : 33-A99



Gladhand Couplers

Code	Description
33-G79850	1/2 NPT Service Line (Blue)
33-G79851	1/2 NPT Emergency Line (Red)
33-GHS	Gladhand Seal

NOTE: SEALING COUPLINGS MUST NOT BE USED WITH SEALING ADAPTORS.

Mounting Plates and Kits (Category 33)



1/2 NPT
Mounting
Bracket

Code : 33-A420



1/2 Prime Mover
Kit & Bracket

Code : 33-CA6202B

PBR Nitex Style Airbrake Fittings (Category 33)



BF101
Olive for
BF102 Nut

Code	Tube
33-BF101-3	3/16
33-BF101-4	1/4
33-BF101-5	5/16
33-BF101-6	3/8
33-BF101-8	1/2



BF102
Tube Nut for
BF101 Olive

Code	Tube	Thread
33-BF102-3	3/16	3/8x24
33-BF102-4	1/4	7/16x20
33-BF102-5	5/16	1/2x20
33-BF102-6	3/8	9/16x18
33-BF102-8	1/2	3/4x16



BF103
Ferrule for
BF104 Nut

Code	Tube	Tube I.D.
33-BF103-2	1/8	0.078
33-BF103-3	3/16	0.110
33-BF103-4	1/4	0.150
33-BF103-5	5/16	0.200
33-BF103-6	3/8	0.225
33-BF103-6R	3/8	0.251
33-BF103-8	1/2	0.375



BF104
Stepped Tube Nut
for BF103 Ferrule

Code	Tube	Thread
33-BF104-2	1/8	5/16x24
33-BF104-3	3/16	3/8x24
33-BF104-4	1/4	7/16x20
33-BF104-5	5/16	1/2x20
33-BF104-6	3/8	9/16x18
33-BF104-8	1/2	3/4x16



BF100
Tube Joiner
Body

Code	Tube
33-BF100-2	1/8
33-BF100-3	3/16
33-BF100-4	1/4
33-BF100-5	5/16
33-BF100-6	3/8
33-BF100-8	1/2



BF105
Male Adapter
Body

Code	Tube	Male
33-BF105-3-2	3/16	1/8 NPT
33-BF105-3-4	3/16	1/4 NPT
33-BF105-4-2	1/4	1/8 NPT
33-BF105-4-4	1/4	1/4 NPT
33-BF105-5-2	5/16	1/8 NPT
33-BF105-5-4	5/16	1/4 NPT
33-BF105-6-2	3/8	1/8 NPT
33-BF105-6-4	3/8	1/4 NPT
33-BF105-6-6	3/8	3/8 NPT
33-BF105-6-8	3/8	1/2 NPT
33-BF105-8-4	1/2	1/4 NPT
33-BF105-8-6	1/2	3/8 NPT
33-BF105-8-8	1/2	1/2 NPT
33-BFB105-4-2	1/4	1/8 BSPT



BF110
Tube Tee
Body

Code	Tube
33-BF110-2	1/8
33-BF110-3	3/16
33-BF110-4	1/4
33-BF110-5	5/16
33-BF110-6	3/8
33-BF110-8	1/2



BF108
Male Elbow
Adapter Body

Code	Tube	Male
33-BF108-3-2	3/16	1/8 NPT
33-BF108-3-4	3/16	1/4 NPT
33-BF108-4-2	1/4	1/8 NPT
33-BF108-4-4	1/4	1/4 NPT
33-BF108-5-2	5/16	1/8 NPT
33-BF108-5-4	5/16	1/4 NPT
33-BF108-5-6	5/16	3/8 NPT
33-BF108-6-2	3/8	1/8 NPT
33-BF108-6-4	3/8	1/4 NPT
33-BF108-6-6	3/8	3/8 NPT
33-BF108-6-8	3/8	1/2 NPT
33-BF108-8-4	1/2	1/4 NPT
33-BF108-8-6	1/2	3/8 NPT
33-BF108-8-8	1/2	1/2 NPT



BF111
Male Branch
Tee Body

Code	Tube	Male
33-BF111-3-2	3/16	1/8 NPT
33-BF111-4-2	1/4	1/8 NPT
33-BF111-5-4	5/16	1/4 NPT
33-BF111-6-4	3/8	1/4 NPT
33-BF111-8-4	1/2	1/4 NPT
33-BF111-8-6	1/2	3/8 NPT



BF112
Male Run
Tee Body

Code	Tube	Male
33-BF112-3-2	3/16	1/8 NPT
33-BF112-4-2	1/4	1/8 NPT
33-BF112-5-4	5/16	1/4 NPT
33-BF112-6-4	3/8	1/4 NPT
33-BF112-8-6	1/2	3/8 NPT

Note : Bodies do not include nuts or ferrules. Please order these separately.

Westinghouse Style Airbrake Fittings (Category 34)

TUBE: Copper, Aluminium, Bundy, Nylon (spigot must be used with nylon tube) **PRESSURE:** Around 3500KPA/500PSI, but if used with nylon tube, it will depend on the pressure rating of the tube.

TEMPERATURE: 0°C to 120°C

TYPICAL USES: For Airbrake systems.

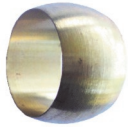
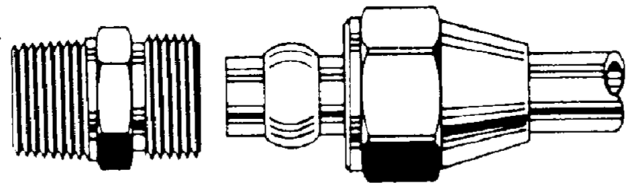

#1BF
Tube
Sleeve

Code	Tube
34-001-04	1/4
34-001-06	3/8
34-001-08	1/2
34-001-10	5/8
34-001-12	3/4



#400BF
Tube
Union

Code	Tube
34-004-04	1/4
34-004-06	3/8
34-004-08	1/2
34-004-10	5/8
34-004-12	3/4



#1000BF
Female
Adaptor

Code	Tube	Female
34-010-0404	1/4	1/4 NPT
34-010-0602	3/8	1/8 NPT
34-010-0604	3/8	1/4 NPT
34-010-0606	3/8	3/8 NPT
34-010-0806	1/2	3/8 NPT
34-010-0808	1/2	1/2 NPT



#200BF
Tube
Nut

Code	Tube
34-002-04	1/4
34-002-06	3/8
34-002-08	1/2
34-002-10	5/8
34-002-12	3/4



#500BF
Male Elbow
Adaptor

Code	Tube	Male
34-005-0402	1/4	1/8 NPT
34-005-0404	1/4	1/4 NPT
34-005-0406	1/4	3/8 NPT
34-005-0602	3/8	1/8 NPT
34-005-0604	3/8	1/4 NPT
34-005-0606	3/8	3/8 NPT
34-005-0608	3/8	1/2 NPT
34-005-0804	1/2	1/4 NPT
34-005-0806	1/2	3/8 NPT
34-005-0808	1/2	1/2 NPT
34-005-1006	5/8	3/8 NPT
34-005-1008	5/8	1/2 NPT
34-005-1212	3/4	3/4 NPT



#1100BF
Union
Elbow

Code	Tube
34-011-04	1/4
34-011-06	3/8
34-011-08	1/2
34-011-10	5/8



#300BF
Male
Adaptor

Code	Tube	Male
34-003-0402	1/4	1/8 NPT
34-003-0404	1/4	1/4 NPT
34-003-0406	1/4	3/8 NPT
34-003-0602	3/8	1/8 NPT
34-003-0604	3/8	1/4 NPT
34-003-0606	3/8	3/8 NPT
34-003-0608	3/8	1/2 NPT
34-003-0804	1/2	1/4 NPT
34-003-0806	1/2	3/8 NPT
34-003-0808	1/2	1/2 NPT
34-003-1006	5/8	3/8 NPT
34-003-1008	5/8	1/2 NPT
34-003-1208	3/4	1/2 NPT
34-003-1212	3/4	3/4 NPT



#500BFD
45° Male
Elbow Adaptor

Code	Tube	Male
34-005D-0604	3/8	1/4 NPT
34-005D-0606	3/8	3/8 NPT
34-005D-0806	1/2	3/8 NPT
34-005D-1008	5/8	1/2 NPT



#1200BF
Male
Branch Tee

Code	Tube	Male
34-012-0404	1/4	1/4 NPT
34-012-0602	3/8	1/8 NPT
34-012-0604	3/8	1/4 NPT
34-012-0606	3/8	3/8 NPT
34-012-0806	1/2	3/8 NPT
34-012-0808	1/2	1/2 NPT
34-012-1008	5/8	1/2 NPT

Westinghouse Style Airbrake Fittings (Category 34)

TUBE: Copper, Aluminium, Bundy, Nylon (spigot must be used with nylon tube) **PRESSURE:** Around 3500KPA/500PSI, but if used with nylon tube, it will depend on the pressure rating of the tube.

TEMPERATURE: 0°C to 120°C

TYPICAL USES: For Airbrake systems.

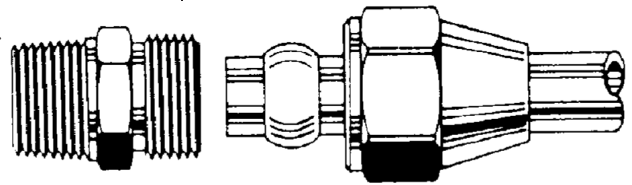

#1300BF
Male
Run Tee

Code	Tube	Male
34-013-0604	3/8	1/4 NPT
34-013-0606	3/8	3/8 NPT
34-013-0806	1/2	3/8 NPT



#1400BF
Union
Tee

Code	Tube
34-014-04	1/4
34-014-06	3/8
34-014-08	1/2
34-014-10	5/8



#1500BF
Female Elbow
Adaptor

Code	Tube	Female
34-015-0604	3/8	1/4 NPT
34-015-0606	3/8	3/8 NPT



#99DS Tube Insert
for DIN74324
Metric Tube

Code	Tube O.D.	Tube I.D.
34-99DS06	6mm	4mm
34-99DS08	8mm	6mm
34-99DS10	10mm	7.5mm
34-99DS12	12mm	9mm
34-99DS15	15mm	12mm
34-99DS18	18mm	14mm



#99JM Tube Insert
for J844A &
J844B Metric Tube

Code	Tube O.D.	Tube I.D.
34-99JMA06	6mm	4mm
34-99JMA08	8mm	6mm
34-99JMB10	10mm	7mm
34-99JMB12	12mm	9mm
34-99JMB16	16mm	12mm



#99J Tube Insert
for J844A &
J844B Imperial
Tube

Code	Tube O.D.	Tube I.D.
34-99JA02	1/8	0.078
34-99JA04	1/4	0.170
34-99JA05	5/16	0.232
34-99JB06	3/8	0.251
34-99JB08	1/2	0.376
34-99JB10	5/8	0.441
34-99JB12	3/4	0.566



#99NX Tube Insert
for Nitex Imperial
Airbrake Tube

Code	Tube O.D.	Tube I.D.
34-99NX02	1/8	0.078
34-99NX03	3/16	0.110
34-99NX04	1/4	0.150
34-99NX05	5/16	0.200
34-99NX06H	3/8	0.225
34-99NX06L	3/8	0.260
34-99NX08	1/2	0.375

Do you need a thread sealant?
We stock various types of thread
tape and a full range of Bondloc
thread lockers and sealants.



INDUSTRIAL FITTINGS SALES
(VIC) Pty. Ltd. ABN 12 051 387 029



16-18 Smeaton Avenue, Dandenong South. Victoria 3175
Phone (03) 8770 1333 Fax (03) 8770 1313
Email : sales@ifsvic.com.au

NTA / 1400 Series Airbrake Fittings (Category 36)

TUBE: Nylon J844 Airbrake Tube.
PRESSURE: Medium pressure rating around 200PSI/1400Kpa decreasing on larger tube sizes and on nylon.
TEMPERATURE: 0° C to 120° C
TYPICAL USES: Airbrake systems

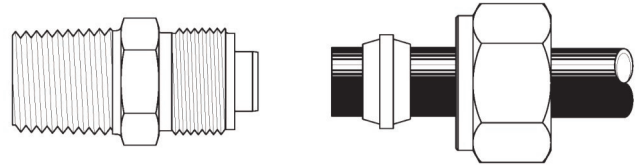

 **D.O.T. Approved Brass Airbrake Fittings for the transport Industry. This range of compression fittings comes pre assembled with the #99NA Tube Insert to fit J844A and J844B Nylon Tube.**



**#1NA
Tube
Olive**

Code	Tube
36-001-04	1/4
36-001-06	3/8
36-001-08	1/2
36-001-10	5/8
36-001-12	3/4



**#2NA
Tube
Nut**

Code	Tube	Thread
36-002-04	1/4	7/16x24
36-002-06	3/8	17/32x24
36-002-08	1/2	11/16x20
36-002-10	5/8	13/16x18
36-002-12	3/4	1''x18

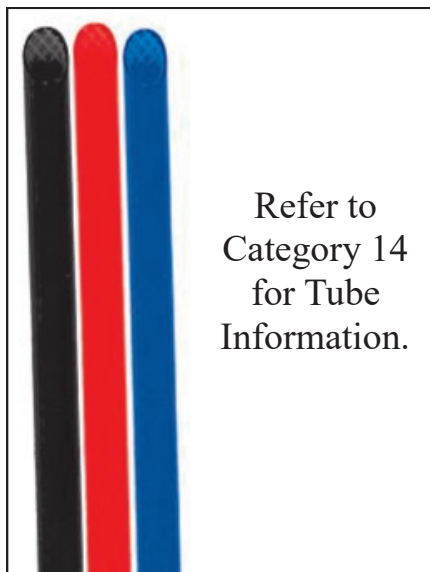

Refer to
Category 14
for Tube
Information.



**#3NA
Male
Adaptor**

Code	Tube	Male
36-003-0401	1/4	1/16 NPT
36-003-0402	1/4	1/8 NPT
36-003-0402BSP	1/4	1/8 BSPT
36-003-0404	1/4	1/4 NPT
36-003-0404BSP	1/4	1/4 BSPT
36-003-0406	1/4	3/8 NPT
36-003-0602	3/8	1/8 NPT
36-003-0602BSP	3/8	1/8 BSPT
36-003-0604	3/8	1/4 NPT
36-003-0604BSP	3/8	1/4 BSPT
36-003-0606	3/8	3/8 NPT
36-003-0608	3/8	1/2 NPT
36-003-0804	1/2	1/4 NPT
36-003-0804BSP	1/2	1/4 BSPT
36-003-0806	1/2	3/8 NPT
36-003-0808	1/2	1/2 NPT
36-003-0812	1/2	3/4 NPT
36-003-1006	5/8	3/8 NPT
36-003-1008	5/8	1/2 NPT
36-003-1012	5/8	3/4 NPT
36-003-1208	3/4	1/2 NPT
36-003-1212	3/4	3/4 NPT



**#4NA
Tube
Union**

Code	Tube
36-004-04	1/4
36-004-06	3/8
36-004-08	1/2
36-004-10	5/8
36-004-12	3/4



**#5NA
Male Elbow
Adaptor**

Code	Tube	Male
36-005-0402	1/4	1/8 NPT
36-005-0404	1/4	1/4 NPT
36-005-0404BSP	1/4	1/4 BSPT
36-005-0406	1/4	3/8 NPT
36-005-0602	3/8	1/8 NPT
36-005-0604	3/8	1/4 NPT
36-005-0604BSP	3/8	1/4 BSPT
36-005-0606	3/8	3/8 NPT
36-005-0608	3/8	1/2 NPT
36-005-0804	1/2	1/4 NPT
36-005-0804BSP	1/2	1/4 BSPT
36-005-0806	1/2	3/8 NPT
36-005-0808	1/2	1/2 NPT
36-005-1006	5/8	3/8 NPT
36-005-1008	5/8	1/2 NPT
36-005-1012	5/8	3/4 NPT
36-005-1208	3/4	1/2 NPT
36-005-1212	3/4	3/4 NPT



**#5NAD
45° Male
Elbow Adaptor**

Code	Tube	Male
36-005D-0402	1/4	1/8 NPT
36-005D-0404	1/4	1/4 NPT
36-005D-0602	3/8	1/8 NPT
36-005D-0604	3/8	1/4 NPT
36-005D-0606	3/8	3/8 NPT
36-005D-0608	3/8	1/2 NPT
36-005D-0804	1/2	1/4 NPT
36-005D-0806	1/2	3/8 NPT
36-005D-0808	1/2	1/2 NPT
36-005D-1006	5/8	3/8 NPT
36-005D-1008	5/8	1/2 NPT

NTA / 1400 Series Airbrake Fittings (Category 36)

TUBE: Nylon J844 Airbrake Tube.

PRESSURE: Medium pressure rating around 200PSI/1400Kpa decreasing on larger tube sizes and on nylon.

TEMPERATURE: 0° C to 120° C

TYPICAL USES: Airbrake systems

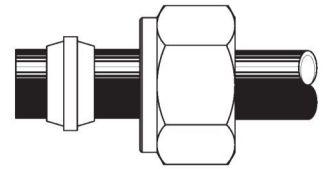
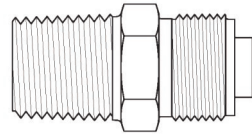

#10NA
Female
Adaptor

Code	Tube	Female
36-010-0402	1/4	1/8 NPT
36-010-0404	1/4	1/4 NPT
36-010-0602	3/8	1/8 NPT
36-010-0604	3/8	1/4 NPT
36-010-0606	3/8	3/8 NPT
36-010-0806	1/2	3/8 NPT
36-010-0808	1/2	1/2 NPT
36-010-1008	5/8	1/2 NPT
36-010-1208	3/4	1/2 NPT



#13NA
Male
Run Tee

Code	Tube	Male
36-013-0402	1/4	1/8 NPT
36-013-0404	1/4	1/4 NPT
36-013-0604	3/8	1/4 NPT
36-013-0606	3/8	3/8 NPT
36-013-0806	1/2	3/8 NPT
36-013-0808	1/2	1/2 NPT
36-013-1008	5/8	1/2 NPT



#31NA
Bulkhead
Tube Union

Code	Tube
36-031-04	1/4
36-031-06	3/8
36-031-08	1/2



#99NA
Tube
Insert

Code	Tube
36-099-04	1/4
36-099-06	3/8
36-099-08	1/2
36-099-10	5/8
36-099-12	3/4



#11NA
Union
Elbow

Code	Tube
36-011-04	1/4
36-011-06	3/8
36-011-08	1/2
36-011-10	5/8



#14NA
Union
Tee

Code	Tube
36-014-04	1/4
36-014-06	3/8
36-014-08	1/2
36-014-10	5/8



#12NA
Male
Branch Tee

Code	Tube	Male
36-012-0402	1/4	1/8 NPT
36-012-0404	1/4	1/4 NPT
36-012-0602	3/8	1/8 NPT
36-012-0604	3/8	1/4 NPT
36-012-0606	3/8	3/8 NPT
36-012-0804	1/2	1/4 NPT
36-012-0806	1/2	3/8 NPT
36-012-0808	1/2	1/2 NPT
36-012-1008	5/8	1/2 NPT



#15NA
Female Elbow
Adaptor

Code	Tube	Female
36-015-0402	1/4	1/8 NPT
36-015-0404	1/4	1/4 NPT
36-015-0602	3/8	1/8 NPT
36-015-0604	3/8	1/4 NPT
36-015-0606	3/8	3/8 NPT
36-015-0806	1/2	3/8 NPT
36-015-0808	1/2	1/2 NPT

ALSO AVAILABLE

SAE J1402 Rubber
Airbrake Hose and Fittings.

Contact the sales office for
further information

Do you need a thread sealant?
We stock various types of thread
tape and a full range of Bondloc
thread lockers and sealants.

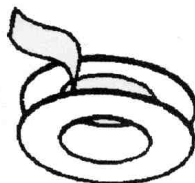

Ball Valves (Category 37)

A.G.A. Approved Full Bore Brass Ball Valve

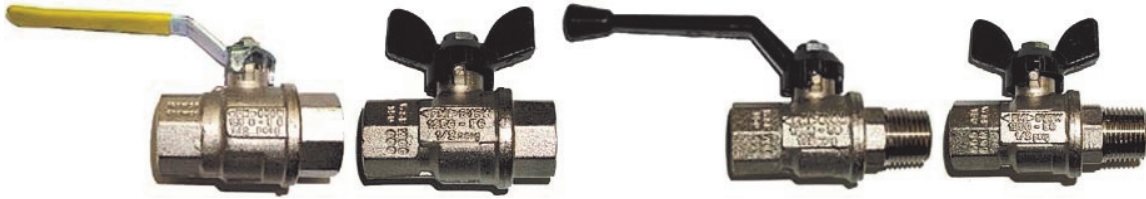

	F&F Lever Handle	F&F T-Handle	M&F Lever Handle	M&F T-Handle
Size	Code	Code	Code	Code
1/4	37-5980-04	37-1720-04	37-1701-04	37-1721-04
3/8	37-5980-06	37-1720-06	37-1701-06	37-1721-06
1/2	37-5980-08	37-1720-08	37-1701-08	37-1721-08
3/4	37-5980-12	37-1720-12	37-1701-12	37-1721-12
1"	37-5980-16	37-1720-16	37-1701-16	37-1721-16
1.1/4	37-5980-20		37-1701-20	
1.1/2	37-5980-24		37-1701-24	
2"	37-5980-32		37-1701-32	
2.1/2	37-5980-40			
3"	37-5980-48			
4"	37-5980-64			

Non Approved Full Bore Brass Ball Valve



	F&F Lever	F&F T-Handle	M&F Lever	M&F T-Handle
Size	Code	Code	Code	Code
1/4	37-1510-04	37-1520-04	37-1501-04	37-1521-04
3/8	37-1510-06	37-1520-06	37-1501-06	37-1521-06
1/2	37-1510-08	37-1520-08	37-1501-08	37-1521-08
3/4	37-1510-12	37-1520-12	37-1501-12	37-1521-12
1"	37-1510-16	37-1520-16	37-1501-16	37-1521-16
1.1/4	37-1510-20	37-1520-20	37-1501-20	37-1521-20
1.1/2	37-1510-24		37-1501-24	
2"	37-1510-32		37-1501-32	
2.1/2	37-1510-40			
3"	37-1510-48			
4"	37-1510-64			

Mini Ball Valve



	F&F	M&F
Size	Code	Code
1/8	37-*3830-02	37-*3831-02
1/4	37-*3830-04	37-*3831-04
3/8	37-*3830-06	37-*3831-06
1/2	37-*3830-08	37-*3831-08

Substitute * to specify brand preference.

B - Itap Red Handle

R - Brescianne Black Handle

SS - Stainless Steel

Ball Valves (Category 37)

Vented Ball Valve F&F Lever Handle



Size	Code
1/4	37-5110-04
3/8	37-5110-06
1/2	37-5110-08
3/4	37-5110-12
1"	37-5110-16

PVC Ball Valve



Size	Code
1/2	37-PVC08
3/4	37-PVC12
1"	37-PVC16
1.1/4	37-PVC20
1.1/2	37-PVC24
2"	37-PVC32
2.1/2	37-PVC40
3"	37-PVC48
4"	37-PVC64

Panel Mount 3-Way Ball Valve



Size	Code
1/4	37-5710-04

Ball Bib-Cock with Hose Tail



Size	Code
3/8	37-4904-06
1/2	37-4904-08
3/4	37-4904-12
1"	37-4904-16

Hi-Press 3000 PSI Ball Valve



Size	Code
3/8	37-HP06
1/2	37-HP08
3/4	37-HP12
1"	37-HP16

Flare x Flare Ball Valve



Tube Size	SAE	BSP
	Code	Code
5/16	37-PFS05	
3/8	37-PFS06	37-PF06
1/2	37-PFS08	37-PF08
3/4		37-PF12

Ball Valves (Category 37)

3-Way Bottom Entry Ball Valve



Size	L-Port	T-Port
	Code	Code
1/4	37-3210-04	37-3110-04
3/8	37-3210-06	37-3110-06
1/2	37-3210-08	37-3110-08
3/4	37-3210-12	37-3110-12
1"	37-3210-16	37-3110-16
1.1/4	37-3210-20	37-3110-20
1.1/2	37-3210-24	37-3110-24
2"	37-3210-32	37-3110-32
3"	37-3210-48	37-3110-48

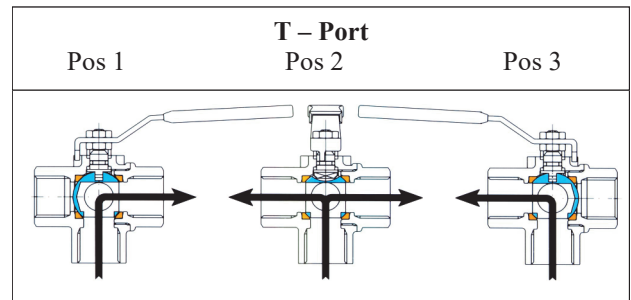
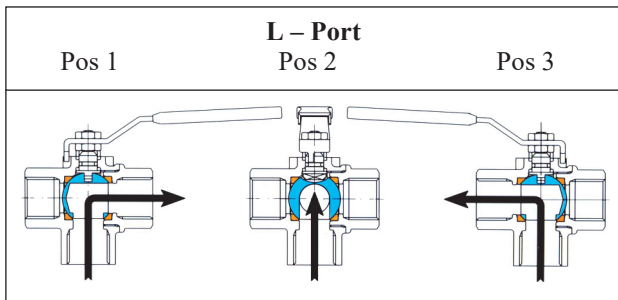

3-Way Side Entry Ball Valve



Size	L-Port	T-Port
	Code	Code
1/4	37-3600-04	37-3500-04
3/8	37-3600-06	37-3500-06
1/2	37-3600-08	37-3500-08
3/4	37-3600-12	37-3500-12
1"	37-3600-16	37-3500-16
1.1/4	37-3600-20	37-3500-20
1.1/2	37-3600-24	37-3500-24
2"	37-3600-32	37-3500-32

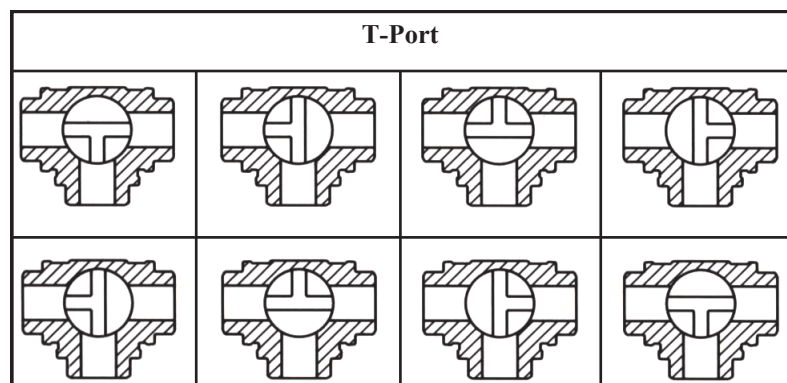
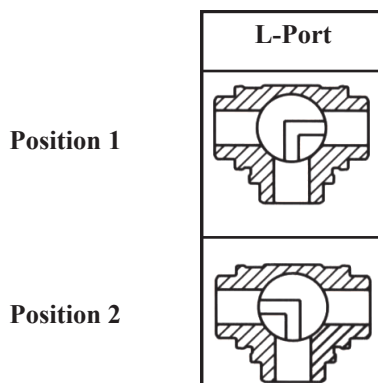

Stainless Steel Ball Valves (Category 37)

One Piece Reduced Bore Stainless Steel Ball Valve



Pressure Rating – 800 PSI

Size	Code
1/4	37-SS1-04
3/8	37-SS1-06
1/2	37-SS1-08
3/4	37-SS1-12
1"	37-SS1-16
1.1/4	37-SS1-20
1.1/2	37-SS1-24
2"	37-SS1-32

Two Piece Full Bore Stainless Steel Ball Valve



Pressure Rating – 1000 PSI

Size	Code
1/4	37-SS2-04
3/8	37-SS2-06
1/2	37-SS2-08
3/4	37-SS2-12
1"	37-SS2-16
1.1/4	37-SS2-20
1.1/2	37-SS2-24
2"	37-SS2-32

Three Piece Full Bore Stainless Steel Ball Valve

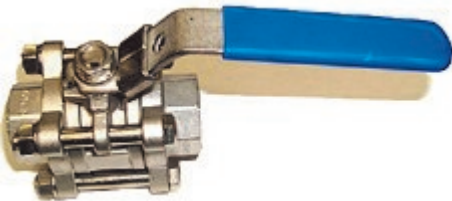

Pressure Rating
 – 1000 PSI (1/4 – 2")
 – 800 PSI (2.1/2 – 4")

Size	Code
1/4	37-SS3-04
3/8	37-SS3-06
1/2	37-SS3-08
3/4	37-SS3-12
1"	37-SS3-16
1.1/4	37-SS3-20
1.1/2	37-SS3-24
2"	37-SS3-32
2.1/2	37-SS3-40
3"	37-SS3-48
4"	37-SS3-64

3-Way Side Entry Stainless Steel Ball Valve



Size	L-Port		T-Port	
	Code	Code	Code	Code
1/4	37-SSL-04	37-SST-04	37-SST-04	37-SST-04
3/8	37-SSL-06	37-SST-06	37-SST-06	37-SST-06
1/2	37-SSL-08	37-SST-08	37-SST-08	37-SST-08
3/4	37-SSL-12	37-SST-12	37-SST-12	37-SST-12
1"	37-SSL-16	37-SST-16	37-SST-16	37-SST-16
1.1/4	37-SSL-20	37-SST-20	37-SST-20	37-SST-20
1.1/2	37-SSL-24	37-SST-24	37-SST-24	37-SST-24
2"	37-SSL-32	37-SST-32	37-SST-32	37-SST-32

Check (Non Return) Valves (Category 38)

Brass Spring Check Valves



- Stainless Steel Spring.
- Nylon 6.6 Stem and Plunger.
- NBR Rubber Seat.
- Suitable for Water, Oil and Gas.
- Can be fitted in horizontal or vertical position.
- Maximum Temp 110° C.
- Easily converts to a Foot Valve with addition of strainers below

Code	Size
38-C06	3/8
38-C08	1/2
38-C12	3/4
38-C16	1"
38-C20	1.1/4
38-C24	1.1/2
38-C32	2"
38-C40	2.1/2
38-C48	3"
38-C64	4"

Spring check Valves also available in Stainless Steel.
Contact the sales office for details

Check Valves Strainers



Code	Size
38-CS06	3/8
38-CS08	1/2
38-CS12	3/4
38-CS16	1"
38-CS20	1.1/4
38-CS24	1.1/2
38-CS32	2"
38-CS40	2.1/2
38-CS48	3"
38-CS64	4"

PVC Spring Check Valves



Code	Size
38-CP08	1/2
38-CP12	3/4
38-CP16	1"
38-CP20	1.1/4
38-CP24	1.1/2
38-CP32	2"

Brass Mini Spring Check Valves



Code	Size
38-CM02	1/8
38-CM04	1/4
38-CM06	3/8
38-CM08	1/2

Valstop Spring Check Valves with Viton Seal



Code	Size
38-VS04	1/4
38-VS06	3/8
38-VS08	1/2
38-VS12	3/4
38-VS16	1"
38-VS20	1.1/4
38-VS24	1.1/2
38-VS32	2"
38-VS40	2.1/2
38-VS48	3"

Swing Check Valves



- Suitable for Horizontal Flow.
- Brass Valves have NBR Seat.
- Stainless Steel Valves have metal to metal seat.

Size	Brass Stainless Steel	
	Code	Code
3/8	38-SC06	
1/2	38-SC08	38-SCSS08
3/4	38-SC12	38-SCSS12
1"	38-SC16	38-SCSS16
1.1/4	38-SC20	38-SCSS20
1.1/2	38-SC24	38-SCSS24
2"	38-SC32	38-SCSS32
2.1/2	38-SC40	
3"	38-SC48	
4"	38-SC64	

Valves (Category 38)

Gate Valve

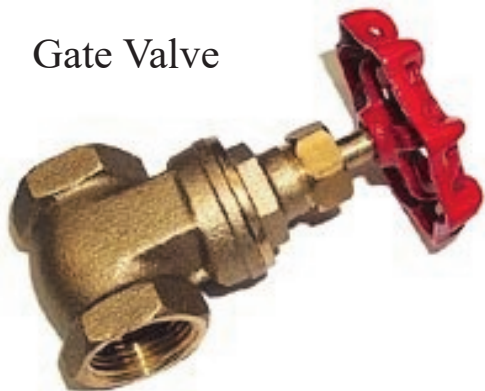

	Brass 10 Bar	Brass 16 Bar	Brass Tested	Stainless Steel
Size	Code	Code	Code	Code
1/4	38-G04			
3/8	38-G06			
1/2	38-G08	38-GH08	38-GT08	38-GSS08
3/4	38-G12	38-GH12	38-GT12	38-GSS12
1"	38-G16	38-GH16	38-GT16	38-GSS16
1.1/4	38-G20	38-GH20	38-GT20	38-GSS20
1.1/2	38-G24	38-GH24	38-GT24	38-GSS24
2"	38-G32	38-GH32	38-GT32	38-GSS32
2.1/2	38-G40	38-GH40	38-GT40	
3"	38-G48	38-GH48	38-GT48	
4"	38-G64			

Foot Valve



	Brass	PVC
Size	Code	Code
1/2	38-F08	
3/4	38-F12	38-FP12
1"	38-F16	38-FP16
1.1/4	38-F20	38-FP20
1.1/2	38-F24	38-FP24
2"	38-F32	38-FP32
2.1/2	38-F40	38-FP40
3"	38-F48	38-FP48
4"	38-F64	

Y-Strainers (Category 38)



	Brass	Stainless Steel
Size	Code	Code
1/4	38-YS04	38-YSS04
3/8	38-YS06	38-YSS06
1/2	38-YS08	38-YSS08
3/4	38-YS12	38-YSS12
1"	38-YS16	38-YSS16
1.1/4	38-YS20	38-YSS20
1.1/2	38-YS24	38-YSS24
2"	38-YS32	38-YSS32
2.1/2	38-YS40	
3"	38-YS48	
4"	38-YS64	

Hose Reels. (Category 40)

Recoila Retractable Air & Water Reels

- Up to a 5 year warranty
- Highest quality 'finished edge' Spring steel strip
- Full flow full DR brass swivels and fluid paths
- Positive crimp hose fittings
- All position positive latching system
- Tough, impact, corrosion resistant and UV stabilized Polypropylene with Anti static and flame retardants
- Unique ratchet tensioning system
- Heavy Duty wall mounting swivel system
- Replaceable protective mouth guard
- Large side covers for easy access in servicing and maintenance routines
- Food grade approved materials
- Unique service locking pin port for added safety
- Two part fully adjustable bumper
- Detailed operation and service manual
- Easy mount drill hole pattern supplied



Code	Type	Hose I.D.	Hose Length	Max Pressure	Inlet	Outlet	Temp Range
40-RAW0815	Air & Water - TPR Hose	8mm	15m	240 psi	3/8 BSPF	3/8 BSPM	-5/+65°C
40-RAW0820	Air & Water - TPR Hose	8mm	20m	240 psi	3/8 BSPF	3/8 BSPM	-5/+65°C
40-RAW1015	Air & Water - TPR Hose	10mm	15m	240 psi	3/8 BSPF	3/8 BSPM	-5/+65°C
40-RAW1020	Air & Water - TPR Hose	10mm	20m	240 psi	3/8 BSPF	3/8 BSPM	-5/+65°C
40-RAW1215	Air & Water - TPR Hose	12mm	15m	240 psi	1/2 BSPF	1/2 BSPM	-5/+65°C
40-RAW1218	Air & Water - TPR Hose	12mm	18m	240 psi	1/2 BSPF	1/2 BSPM	-5/+65°C
40-RAWHD1210	Air/Water - Rubber Hose	12mm	10m	240 psi	1/2 BSPF	1/2 BSPM	-5/+65°C
40-RBD0820	Air Breathing	8mm	20m	240 psi	3/8 BSPF	3/8 BSPM	-5/+60°C
40-RBD1020	Air Breathing	10mm	20m	240 psi	3/8 BSPF	3/8 BSPM	-5/+60°C
40-RDW1218	Drinking Water	12mm	18m	240 psi	3/8 BSPF	3/8 BSPM	-5/+60°C
40-RG1218	Garden Hose	12mm	18m	240 psi	1/2 BSPF	Hose	-5/+60°C
40-RHPW0615	High Pressure Air / Water	6mm	15m	1500 psi	1/4 NPTF	1/4 BSPM	-30/+90°C
40-RHPW1015	High Pressure Air / Water	10mm	15m	1500 psi	1/4 NPTF	3/8 BSPM	-30/+90°C
40-RHW1015	Hot Wash	10mm	15m	240 psi	3/8 BSPF	3/8 BSPM	-30/+85°C
40-RHW1020	Hot Wash	10mm	20m	240 psi	3/8 BSPF	3/8 BSPM	-30/+85°C
40-RHW1215	Hot Wash	12mm	20m	240 psi	1/2 BSPF	1/2 BSPM	-30/+85°C

Recoila Compact Retractable Air & Water Reels



ReCoila® Gen IV GP series reels are the perfect solution for small to medium workshop applications where size is important or short hose lengths are all that is required. Ideal applications are service vans, under bench, assembly lines, home handyman. These reels are supplied complete with 1.5-m of inlet connection hose.

Maximum Pressure : 240 psi. Temperature range : -5/+65°C

Code	Type	Hose I.D.	Hose Length	Inlet	Outlet
40-RGP0612	Air & Water - TPR Hose	6mm	12m	3/8 BSPF	1/4 BSPM
40-RGP0812	Air & Water - TPR Hose	8mm	12m	3/8 BSPF	3/8 BSPM
40-RGP1010	Air & Water - TPR Hose	10mm	10m	3/8 BSPF	3/8 BSPM

Hose Reels. (Category 40)

Recoila Retractable Gas & Welding Reels



These reels are an ideal compact solution for all gas welding and cutting applications. The unique external swivel design on the oxygen and fuel gas reels provides added safety and ease of O ring and seal replacement. When hoses are stored by wrapping them around the bottles or trolleys there is a greater potential of a fire risk. By installing a ReCoila® gas reel you not only create a safer working environment, but also extend the hose life and gain productivity efficiencies.

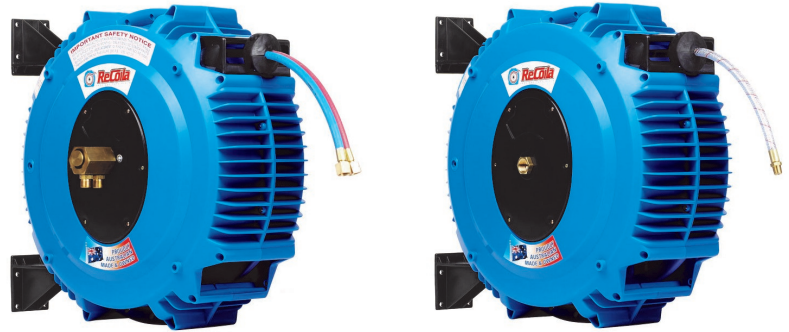

Code	Type	Hose I.D.	Hose Length	Max Pressure	Inlet	Outlet	Temp Range
40-RA0620	Argon	5mm	20m	300 psi	5/8 UNFM	5/8 UNFF	-20/+80°C
40-RFD0620	Food Gas / CO2	6mm	20m	240 psi	3/8 BSPF	1/4 BSPM	-30/+65°C
40-RFD0820	Food Gas / CO2	8mm	20m	240 psi	3/8 BSPF	3/8 BSPM	-30/+65°C
40-RFD1020	Food Gas / CO2	10mm	20m	240 psi	3/8 BSPF	3/8 BSPM	-30/+65°C
40-RN1015	Nitrogen	10mm	15m	600 psi	3/8 BSPF	3/8 BSPM	-30/+90°C
40-ROA0608	Oxy Acetylene Twin	5mm	8m	300 psi	5/8 UNFM	5/8 UNFF	-20/+80°C
40-ROA0615	Oxy Acetylene Twin	5mm	15m	300 psi	5/8 UNFM	5/8 UNFF	-20/+80°C
40-ROP0608	Oxy Propane Twin	5mm	8m	300 psi	5/8 UNFM	5/8 UNFF	-20/+80°C
40-ROP0615	Oxy Propane Twin	5mm	15m	300 psi	5/8 UNFM	5/8 UNFF	-20/+80°C
40-RP0620	Propane	5mm	20m	300 psi	5/8 UNFM	5/8 UNFF	-20/+80°C
40-RP1015	Propane	10mm	15m	300 psi	5/8 UNFM	5/8 UNFF	-20/+80°C

Recoila Retractable Pesticide / Chemical Reels



ReCoila® Gen III WP series offers a lightweight corrosion proof solution for the dispensing of herbicides and pesticides. Ideally suited to spot spraying from quad bikes and small vehicles.

Maximum Pressure : 240 psi. Temperature range : -5/+60°C

Code	Type	Hose I.D.	Hose Length	Inlet	Outlet
40-RWP1015	Pesticide / Chemical	10mm	15m	3/8 BSPF	3/8 BSPM
40-RWP1020	Pesticide / Chemical	10mm	20m	3/8 BSPF	3/8 BSPM
40-RWP1215	Pesticide / Chemical	12mm	15m	3/8 BSPF	3/8 BSPM
40-RWP1218	Pesticide / Chemical	12mm	18m	1/2 BSPF	1/2 BSPM

Recoila Retractable Lubrication Hose Reels



ReCoila® Gen III OL and GR series reels are the ideal solution for light duty oil and grease transfer applications.

Temperature Range : -30/+90°C

Code	Type	Hose I.D.	Hose Length	Max Pressure	Inlet	Outlet
40-RGR0615	Grease	6mm	15m	5000 psi	1/4 NPTF	1/4 BSPM
40-ROL1015	Oil	10mm	15m	1200 psi	3/8 BSPF	3/8 BSPM
40-ROL1210	Oil	12mm	10m	1200 psi	1/2 BSPF	1/2 BSPM

Electrical & Safety Barrier Reels. (Category 40)

Recoila Retractable Electric Cord & Forklift Recharge Reels

ReCoila® Gen III EL & ELDC series reels offers an ideal solution for managing and storing electrical cord and fork-lift recharging cables. Over heating cables and poor recharges are generally a result of damaged cables and connections from being left laying around. Installing a recharge reel will not only increase the life expectancy of the cables and connectors but will make the operation of recharging more efficient and offer a safer tidier work area.

*N/S = Not Supplied



Code	Type	Amps	Cable	Cable Length	Cores	Inlet	Outlet
40-REL2402010	Electric Cord 240 VAC	10	1 mm ²	20m	3	Plug	Socket
40-REL2402015	Electric Cord 240 VAC	15	2.4 mm ²	20m	3	Plug	Socket
40-REL4152010	Electric Cord 3 Phase 415 VAC	10	2.4 mm ²	20m	4	*N/S	*N/S
40-REL4152015	Electric Cord 3 Phase 415 VAC	15	2.4 mm ²	20m	4	*N/S	*N/S
40-REL4152020	Electric Cord 3 Phase 415 VAC	30	2.4 mm ²	20m	4	*N/S	*N/S
40-REL4152032	Electric Cord 3 Phase 415 VAC	32	4 mm ²	20m	4	*N/S	*N/S
40-RELDC6050	Forklift Recharge 600 VDC	50	16 mm ²	5m	2	Plug	Socket
40-RELDC6175	Forklift Recharge 600 VDC	175	16 mm ²	5m	2	Plug	Socket
40-RELDC6350	Forklift Recharge 600 VDC	350	16 mm ²	5m	2	Plug	Socket

Recoila Compact Retractable Electric Cord & Light Reels

ReCoila® Gen IV E & L series reels are the perfect solution to ensuring cables and cords are stored safely when not in use. When cables and cords are left laying around they are easily damaged resulting in a potential electrocution. The L Series reel comes complete with a light which is ideally suited for mechanical workshops and panel shops.



The L Series reel has an inline transformer at the plug offering 32 VAC to the fluorescent light.

Code	Type	Amps	Length	Cores	Inlet	Outlet
40-REL2401210	Electric 240 VAC	10	10m	3	Plug	Socket
40-REL2401215	Electric 240 VAC	15	15m	3	Plug	Socket
40-RL24032610	Electric 240 VAC	10	10m	2	Plug	Light

Recoila Retractable Safety Barrier Reels

Fitted with 15m of 50mm wide woven webbing (safety orange) or 15m of polyurethane chain (safety yellow) the ReCoila® Barrier Reels are the ideal way to quickly & efficiently set up personnel safety barriers for areas that require regular guarding. Additionally these reels are widely used to cordon off roller doors that are required to be open for light and air movement and frequent traffic however need to be restricted access.

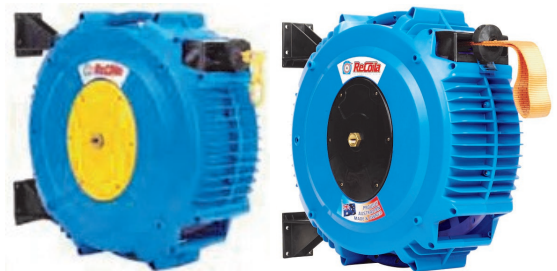

Code	Type	Length	End Fitting
40-RBAR5015	50mm Woven Webbing	20m	Sewn Loop
40-RBARC15	6x36mm Polyurethane Chain	15m	Link

Hose Reels. (Category 40)

Air Hose Balancer

Hose : 5mm I.D. Polyurethane
 Length : 2 Metres
 Outlet : 1/4 Male BSP
 Working Pressure : 100psi

Code : 40-HR0502



Spring Rewind Air Reel

Hose : 6.5mm I.D. Polyurethane
 Length : 6 Metres
 Outlet : 1/4 Male BSP
 Working Pressure : 100psi

Code : 40-HR0606



Hand Wind Air Reels

- Full Metal Construction
- Powder Coated Finish
- 360° Swivel Base
- 220 psi Working Pressure

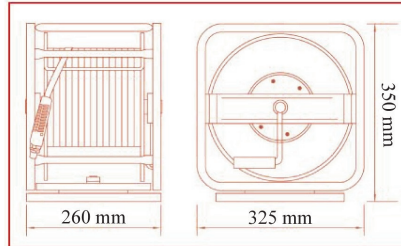

Code	Hose	Length	Inlet	Outlet
40-HR0840	8mm I.D. Braided Polyurethane	40m	1/4 BSP	1/4 BSP
40-HR1030	10mm I.D. Braided Polyurethane	30m	3/8 BSP	3/8 BSP

Heavy Duty Manual Hose Reelers

- Can be Fitted with Hose on Request
- Heavy Duty Hose Reel
- Fully Galvanised
- Greased Axle and Lubrication Points
- Also available with disc ends instead of spokes.
- Reels can be modified to suit Customer Needs
- Other sizes available on request.
- All dimensions in millimetres.

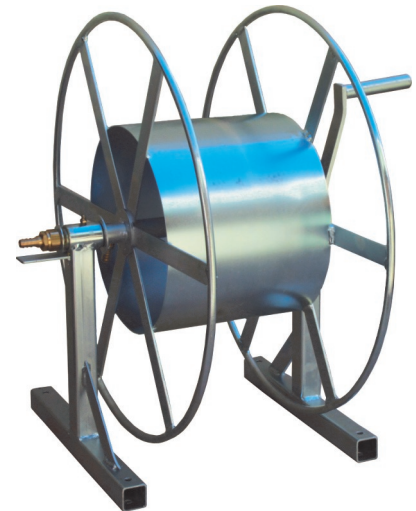
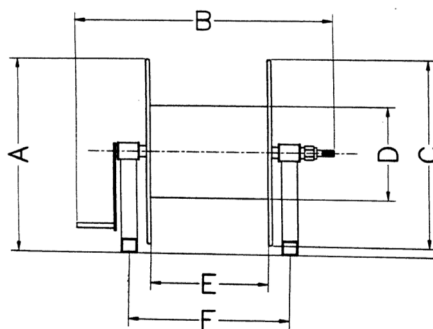

Code	Hose I.D.	Capacity	A	B	C	D	E	F
40-M06100	6mm (1/4)	100 m	460	500	425	170	200	310
40-M05100	8mm (5/16)	100 m	460	500	425	170	200	310
40-M06050	10mm (3/8)	50 m	460	500	425	170	200	310
40-M06100	10mm (3/8)	100 m	540	510	515	250	210	320
40-M08050	12mm (1/2)	50 m	460	500	425	170	200	350
40-M08100	12mm (1/2)	100 m	460	640	425	170	380	450
40-M10100	16mm (5/8)	100 m	580	600	550	250	300	410
40-M12040	20mm (3/4)	40 m	540	510	515	250	210	320
40-M12060	20mm (3/4)	60 m	540	600	515	250	300	410
40-M12100	20mm (3/4)	100 m	630	600	600	250	300	410
40-M16026	25mm (1")	26 m	540	510	515	250	210	320
40-M16040	25mm (1")	40 m	540	630	515	250	300	410
40-M16060	25mm (1")	60 m	630	520	600	250	300	410

Polyurethane Spiral Hoses (Category 43)



Code	Tube Size	W / Length	Colour
43-PT0602L-M4S	6x4 mm	2 Metres	Blue
43-PT0605L-M4S	6x4 mm	5 Metres	Blue
43-PT0607L-M4S	6x4 mm	7 Metres	Blue
43-PT08015O-M4S	8x5 mm	1.5 Metres	Orange
43-PT0803O-M4S	8x5 mm	3 Metres	Orange
43-PT0805O-M4S	8x5 mm	5 Metres	Orange
43-PT0807O-M4S	8x5 mm	7 Metres	Orange
43-PT10015L-M4S	10x6.5 mm	1.5 Metres	Blue
43-PT1003L-M4S	10x6.5 mm	3 Metres	Blue
43-PT1005L-M4S	10x6.5 mm	5 Metres	Blue
43-PT1007L-M4S	10x6.5 mm	7 Metres	Blue
43-PT1013L-M4S	10x6.5 mm	13 Metres	Blue
43-PT1203L-M4S	12x8 mm	3 Metres	Blue
43-PT1205L-M4S	12x8 mm	5 Metres	Blue
43-PT1207L-M4S	12x8 mm	7 Metres	Blue

- All Hoses supplied standard with 1/4 BSPT Male Swivel ends and a protective spring.
- Spare end fittings also available.
- Other colours available in most sizes. Contact the sales office with your colour requirement.

Twin Coils



Code	Tube Size	W/Length	Colour
43-PCT0604BL	6x4 mm	4 Metres	Blue / Black
43-PCT0606BL	6x4 mm	6 Metres	Blue / Black
43-PCT0608BL	6x4 mm	8 Metres	Blue / Black
43-PCT0806BL	8x5 mm	6 Metres	Blue / Black
43-PCT0808BL	8x5 mm	8 Metres	Blue / Black
43-PCT0812BL	8x5 mm	12 Metres	Blue / Black
43-PCT1006BL	10x6.5 mm	6 Metres	Blue / Black
43-PCT1008BL	10x6.5 mm	8 Metres	Blue / Black
43-PCT1012BL	10x6.5 mm	12 Metres	Blue / Black

- All Hoses supplied unfitted. Please advise sales staff what ends are required.
- Other colours and size combinations available. Contact the sales office with your requirements.



Custom hoses available with coupler ends, blowguns or push-in fittings. Let us know what you need.

Nylon Self Store Coils and Truck Suzi-Coils also available. Refer Category 14.

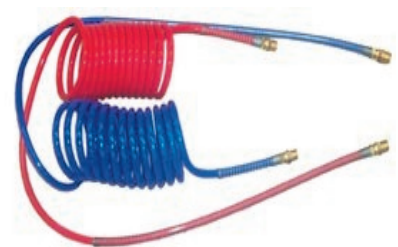

Annealed Seamless Copper Tube (Category 45)

Imperial Copper Tube - Manufactured to AS1432

Sold in Full Coils Only



Code	Tube Size Imperial	Tube Size Metric	Coil Length	Working Pressure Max (PSI)	Burst Pressure (PSI)
45-0220	1/8x20#	3.18x0.91	6m	4200	16900
45-0222	1/8x22#	3.18x0.71	30m	2900	13200
45-0320	3/16x20#	4.76x0.91	6m/12m/30m	2450	11090
45-0420	1/4x20#	6.35x0.91	6m/12m/30m	1750	8300
45-0520	5/16x20#	7.94x0.91	6m/12m/30m	1360	6640
45-0620	3/8x20#	9.52x0.91	6m/12m/18m	1110	5540
45-0820	1/2x20#	12.7x0.91	6m/12m/18m	810	4150
45-1020	5/8x20#	15.9x0.91	18m	640	3320
45-1220	3/4x20#	19.0x0.91	18m	530	2770
45-1618	1"x18#	25.4x1.22	18m	535	2780

Japanese Metric Copper Tube to JIS C1220T (ASTM C22200)

Sold in Full Coils Only



Code	Tube Size Metric	Coil Length	Working Pressure Max (KPA)	Burst Pressure (KPA)
45-M0407	4mm x 0.75	10m/20m	16020	75000
45-M0610	6mm x 1.00	10m/20m	14570	66660
45-M1010	10mm x 1.00	10m/20m	8160	40000
45-M1210	12mm x 1.00	10m/20m	6690	33330

Hard Drawn Copper Tube (Category 45)



Code	Tube Size Imperial	Tube Size Metric	Length	Working Pressure Max (PSI)	Burst Pressure (PSI)
45-H0420	1/4x20#	6.35x0.91	6m	1750	8300
45-H0520	5/16x20#	7.94x0.91	6m	1360	6640
45-H0620	3/8x20#	9.52x0.91	6m	1110	5540
45-H0819	1/2x19#	12.7x1.02	6m	950	4860
45-H0820	1/2x20#	12.7x0.91	6m	810	4150
45-H1219	3/4x19#	19.0x1.02	6m	600	3130
45-H1618	1"x18#	25.4x1.22	6m	535	2780

The working pressures listed above are theoretical working pressures based on a tensile strength of 30,000 PSI (206 MPA) and a temperature range of -29° to 38° C (-20° to 100° F).

For higher temperatures, the table to the right can be used as a guide. Multiply the working pressure of the tube by the multiplication factor for the relevant temperature. E.g. : The working pressure of 3/8x20# tube @ 149°C = 1212x0.78 = 945 PSI.

Precautions should be taken to prevent mediums such as water from freezing within the tube as this can result in the tube bursting.

Temp °C	Multiplication Factor
66	0.85
93	0.80
121	0.80
149	0.78
177	0.67
204	0.50

Bundyweld Steel Tubing (Category 45)

Tube Size Imperial	Tube Size Metric	Standard Length	Product Code	Working Pressure Max (PSI)	Burst Pressure (PSI)
3/16x22#	4.76x0.71	5.3m	45-B0322	2770	13870
1/4x22#	6.35x0.71	5.3m	45-B0422	2000	10074
5/16x22#	7.94x0.71	5.3m	45-B0522	1570	7884
3/8x22#	9.52x0.71	5.3m	45-B0622	1430	7151

- Sold only in full 5.3 metre lengths.
- Can be supplied in straight lengths or coiled.
- Bundy Tube comes copper coated to help prevent corrosion.

Stainless Steel Tubing (Category 45)

Seamless 316 Stainless Steel Tubing Cold Drawn to ASTM A269 or Equivalent

Product Code	Tube Size (O.D.xW.T.)	Working Pres. (PSI)
46-SS02-20	1/8x20# (3.18x0.91)	11854
46-SS03-20	3/16x20# (4.76x0.91)	7190
46-SS04-16	1/4x20# (6.35x1.63)	10100
46-SS04-18	1/4x18# (6.35x1.22)	7500
46-SS04-20	1/4x20# (6.35x0.91)	5159
46-SS05-20	5/16x20# (7.94x0.91)	4023
46-SS06-16	3/8x16# (9.53x1.63)	6320
46-SS06-18	3/8x18# (9.53x1.22)	4549
46-SS06-20	3/8x20# (9.53x0.91)	3297
46-SS08-16	1/2x16# (12.7x1.63)	4559
46-SS08-18	1/2x18# (12.7x1.22)	3317
46-SS08-20	1/2x20# (12.7x0.91)	2423
46-SS10-16	5/8x16# (15.88x1.63)	3775
46-SS12-16	3/4x16# (19.05x1.63)	3100
46-SS12-18	3/4x18# (19.05x1.22)	2278
46-SS16-14	1"x14# (25.4x2.03)	2988
46-SS16-16	1"x16# (25.4x1.63)	2283
46-SSM06	6mm x 1mm	5442
46-SSM10	10mm x 1.5mm	5225
46-SSM12	12mm x 1.5mm	4354



The working pressures listed above are theoretical working pressures based on a tensile strength of 75000 PSI, a safety factor of 4:1 and a temperature range of -198° to 37° C (-325° to 100° F).

For higher temperatures, the following table can be used as a guide. Multiply the working pressure of the tube by the multiplication factor for the relevant temperature.

Eg : The working pressure of 3/8x20# tube @ 510°C = 3297x0.82 = 2703 PSI.

Temp °C	Multiplication Factor	Temp °C	Multiplication Factor	Temp °C	Multiplication Factor
66	1.00	316	0.91	566	0.81
93	1.00	343	0.89	593	0.66
121	0.99	371	0.87	649	0.40
149	0.98	399	0.86	677	0.29
177	0.97	427	0.84	704	0.22
204	0.96	454	0.84	732	0.17
232	0.96	482	0.83	760	0.12
260	0.96	510	0.82	788	0.09
288	0.94	538	0.82	815	0.07

Two Ear Clips (Category 50)

The use of Two-ear clips is an economical solution for many simple hose assemblies, used with air or other fluids. The two ears give the clip extra grip and help to maintain constant pressure around the hose. Fitting is more flexible and exact. The practical design of Two-ear clips means that they clamp firmly on to the assembly and are tamper-proof once mounted. The edges are rounded to avoid damage to the hose. Two-ear clips offer great versatility in simple hose assemblies.

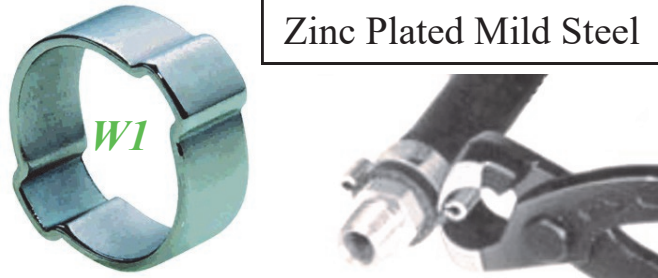

Code	Range	A	B	C	D	E
50-E2-0507	5-7 mm	7.3	4.3	6	11	0.6
50-E2-0709	7-9 mm	9.3	4.8	6	14	0.8
50-E2-0911	9-11 mm	11	5.3	6.5	17	0.8
50-E2-1113	11-13 mm	13	5.8	6.5	19	0.9
50-E2-1315	13-15 mm	15	6.3	7	22	1
50-E2-1417	14-17 mm	18	6.6	7	24	1.2
50-E2-1518	15-18 mm	19	7	7.5	25	1.2
50-E2-1720	17-20 mm	21	7.6	7.5	27	1.2
50-E2-2023	20-23 mm	24	8.5	8	31	1.3
50-E2-2225	22-25 mm	26	9.1	8.5	33	1.4
50-E2-2327	23-27 mm	28	9.4	8.5	35	1.4
50-E2-2528	25-28 mm	29	10	9	36	1.4
50-E2-2831	28-31 mm	32	11	9	39	1.4
50-E2-3134	31-34 mm	35	11	9.5	42	1.4
50-E2-3437	34-37 mm	38	12	9.5	46	1.6
50-E2-3740	37-40 mm	41	12	10	49	1.6
50-E2-4043	40-43 mm	44	13	10	53	1.6
50-E2-4346	43-46 mm	47	13	10.5	56	1.6

Code	Range	A	B	C	D	E
50-ES2-0507	5-7 mm	7.3	4.3	6.0	11.5	0.6
50-ES2-0709	7-9 mm	9.3	4.8	6.0	14.5	0.8
50-ES2-0911	9-11 mm	11.3	5.3	6.5	16.5	0.8
50-ES2-1113	11-13 mm	13.3	5.8	6.5	19.0	0.8
50-ES2-1315	13-15 mm	15.3	6.3	7.0	21.5	1.0
50-ES2-1518	15-18 mm	18.5	7.0	7.5	25.0	1.0
50-ES2-1720	17-20 mm	20.5	7.6	7.5	27.0	1.0
50-ES2-2023	20-23 mm	23.5	8.5	8.0	30.5	1.0
50-ES2-2327	23-27 mm	27.5	9.4	8.5	35.0	1.4
50-ES2-2528	25-28 mm	28.5	10.0	9.0	36.0	1.4
50-ES2-2831	28-31 mm	31.5	10.6	9.0	39.0	1.4

Due to the AISI-304 steel used in the manufacturer of these clips, their corrosion resistance is outstanding. They are recommended especially in outdoor applications.

Steel Materials

Band:
St 34 steel (DIN 2393C)
Finish:
Silver-white Cr3 Zinc Plated

Stainless Materials

Band:
AISI-304 Stainless steel (A2)
Finish:
100% Stainless Steel

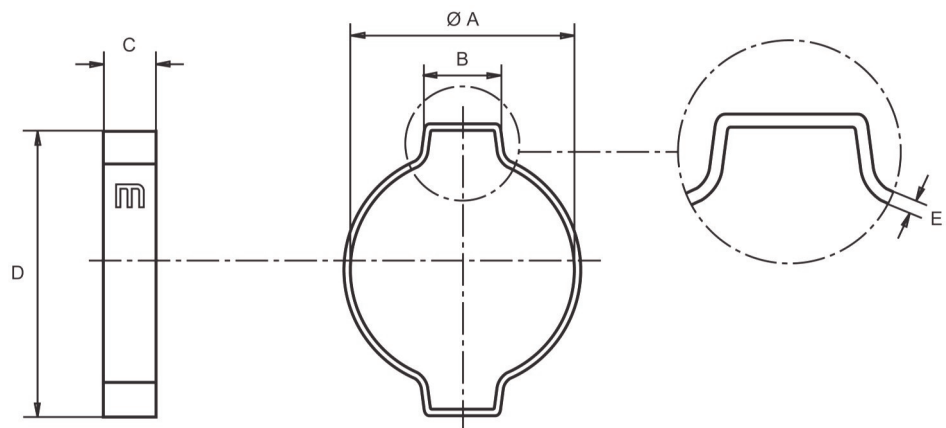

Code: 50-ECP1099
Ear Clamp Pincers
Side & Top Join

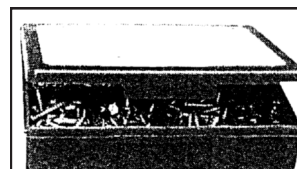

Assortment Kits also available.
Contact the sales staff for further information.

Mini Clamps (Category 50)



W1



**Zinc Plated
Mild Steel
Mini Clip W1**

Some sizes still available in Stainless Steel

Code	Range	r	e	a	b	s	Max Torque	Max Pressure
50-M06	6 mm	M3	5	8.4	9	0.5	0.4 Nm	15.0 Bar
50-M08	8 mm	M3	5	9.0	9	0.5	0.4 Nm	14.0 Bar
50-M09	9 mm	M4	6	10.0	10	0.5	1 Nm	15.0 Bar
50-M10	9.5-10 mm	M4	6	10.0	10	0.5	1 Nm	14.0 Bar
50-M11	10-11 mm	M4	6	10.0	10	0.5	1 Nm	13.0 Bar
50-M12	11-12 mm	M4	6	10.0	10	0.5	1 Nm	12.5 Bar
50-M13	12-13 mm	M4	6	10.0	10	0.5	1 Nm	12.5 Bar
50-M14	13-14 mm	M4	6	10.0	10	0.5	1 Nm	12.5 Bar
50-M15	14-15 mm	M4	6	10.0	10	0.5	1 Nm	12.0 Bar
50-M17	15-17 mm	M4	6	10.0	10	0.5	1 Nm	12.0 Bar

The use of malleable mild steel in the manufacture of the mini clip means that when tightened, the clip adapts perfectly to the hose, clamping firmly but gently. This clip is recommended for use with gaseous fluids at low pressure. Mini Clip also has many applications in the automotive industry.

The maximum pressure may vary depending On the type of hose and coupling used

Some larger sizes also available

W1 Materials

- Screw:** 6.6 strength Grey-white Cr3 zinc plated
- Nut:** 6 strength White Cr3 zinc plated
- Band:** St 02Z (DIN 1.0226)

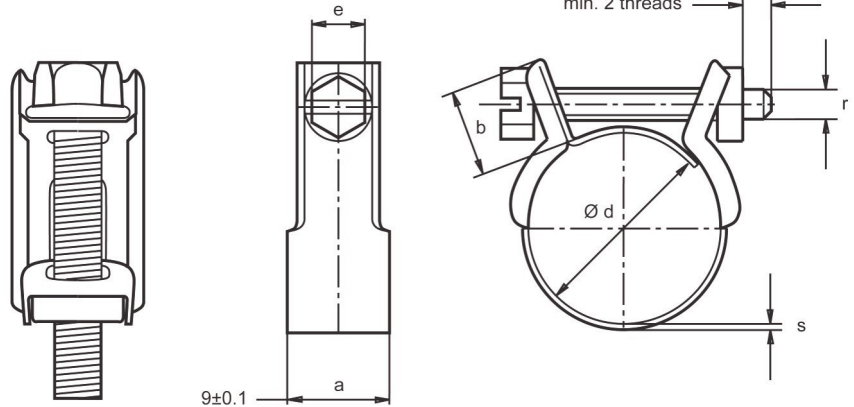

Cobra Style Clamps (Category 50)



**W4 Full
Stainless Steel**



W4

The design of the locking device of the Cobra Style Clamp allows for great precision when mounting. This device, together with the folds in the material confers a spring function to this clamp, meaning that it can maintain constant pressure around the hose. The rounded band edges avoid damage to the hose. This clamp is especially suited for use in assembly lines and industrial applications due to the ease with which it can be mounted and the AISI 304 material employed in its manufacture.

Code	Range	Bandwidth
50-C075	8.0-9.0 mm	7 mm
50-C08	8.5-9.5 mm	7 mm
50-C085	9.0-10.0 mm	7 mm
50-C09	9.5-10.5 mm	7 mm
50-C10	10.5-11.5 mm	7 mm
50-C11	11.5-12.5 mm	7 mm
50-C115	12.0-13.5 mm	8 mm
50-C12	12.5-14.0 mm	8 mm
50-C13	13.5-15.0 mm	8 mm
50-C14	14.5-16.0 mm	8 mm
50-C15	15.5-17.0 mm	8 mm
50-C16	16.5-18.0 mm	8 mm
50-C17	17.5-19.0 mm	8 mm
50-C18	18.5-20.0 mm	8 mm
50-C19	19.5-21.0 mm	8 mm
50-C20	20.5-22.0 mm	8 mm
50-C21	21.5-23.0 mm	8 mm
50-C22	22.5-24.0 mm	8 mm
50-C23	23.5-25.0 mm	8 mm
50-C24	24.5-26.0 mm	8 mm

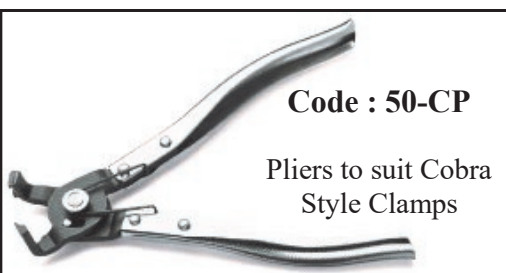

Code : 50-CP

Pliers to suit Cobra Style Clamps

W4 Materials

- Band:** AISI 304 (A2) Stainless Spring Steel

Worm Drive Clamps (Category 50)



W2L

MIKALOR

**ASFA-L W2 Clamps
9mm Band Width
Stainless Band
Steel Screw**

Thanks to the exclusive design of the housing, the ASFA-L W2 hose clip has excellent performance while being at the same time very compact. The cold formed stamped band thread, smoothed on the underside, combined with bevelled band-edges protects the hose from damage. The AISI-430 Stainless steel finish of the band and housing make this a very attractive clip.

The ASFA-L W2 hose clip complies fully with the DIN 3017 norm and also with the RoH's directive EU 20032/95/EC dated 1st July 2006.

This clip is very popular in the hardware and domestic markets and in automotive applications.

*The maximum application pressure can vary depending on the type of hose used and the geometry of the coupling.

Code	Range	s + 0.1	a + 0.3 -0.02	b	Max Torque	Max Pressure
50-W209-012	8-12 mm	0.6	7.5	11.5	1.5 Nm	40 Bar
50-W209-016	8-16 mm	0.6	9	14	3.0 Nm	45 Bar
50-W209-022	12-22 mm	0.6	9	14	3.0 Nm	45 Bar
50-W209-027	16-27 mm	0.7	9	14	3.5 Nm	42 Bar
50-W209-032	20-32 mm	0.7	9	14	3.5 Nm	36 Bar
50-W209-040	25-40 mm	0.7	9	14	4.0 Nm	32 Bar
50-W209-045	30-45 mm	0.7	9	14	4.0 Nm	28 Bar
50-W209-050	32-50 mm	0.7	9	14	4.0 Nm	24 Bar
50-W209-060	40-60 mm	0.7	9	14	4.0 Nm	19 Bar
50-W209-070	50-70 mm	0.7	9	14	4.0 Nm	17 Bar
50-W209-080	60-80 mm	0.7	9	14	4.0 Nm	15 Bar
50-W209-090	70-90 mm	0.7	9	14	4.0 Nm	13 Bar
50-W209-100	80-100 mm	0.7	9	14	4.0 Nm	11 Bar
50-W209-110	90-110 mm	0.7	9	14	4.0 Nm	10 Bar
50-W209-120	100-120 mm	0.7	9	14	4.0 Nm	9 Bar
50-W209-130	110-130 mm	0.7	9	14	4.0 Nm	8 Bar
50-W209-140	120-140 mm	0.7	9	14	4.0 Nm	7 Bar
50-W209-150	130-150 mm	0.7	9	14	4.0 Nm	6 Bar
50-W209-160	140-160 mm	0.7	9	14	4.0 Nm	5 Bar

W2 Materials

Screw:

Qst 36-3 Mild steel
(DIN 1.0213)
Silver-white Cr3 Zinc Plated

Band and Housing:

X6Cr17 Stainless steel
(DIN 1.4016) (AISI-430)

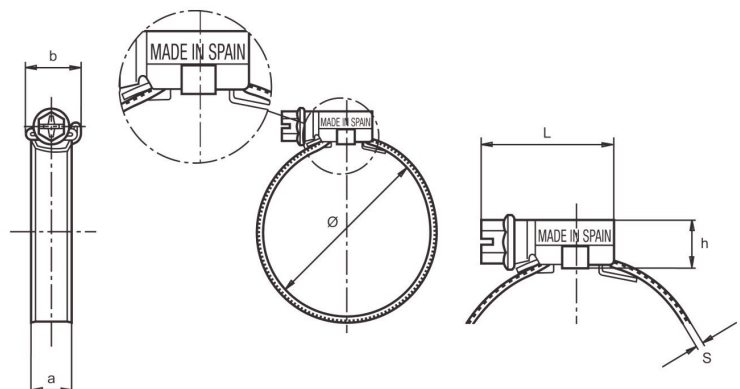

Flexdrivers for Worm Drive Clamps

Code	Screw	Length
50-FD7	7mm	27cm
50-FD7L	7mm	60cm
50-FD6/8	6,8 mm	27cm



Worm Drive Clamps (Category 50)



W2S

MIKALOR

**ASFA-S W2 Clamps
12mm Band Width
Stainless Band
Steel Screw**

The ASFA-S W2 hose clip combines an innovative housing and a sturdy 12mm band which together make this a high performance hose clip. The cold-formed stamped band thread, smoothed on the underside, combined with beveled band edges protects the hose from any damage. The AISI-430 Stainless steel finish of the band and housing make this a very attractive clip.

The ASFA-S W2 hose clip complies fully with the DIN 3017 norm and also with the RoH's directive EU 20032/95/EC dated 1st July 2006.

This clip is ideally for use in automotive applications, in agriculture and in fluid transfer applications.

*The maximum application pressure can vary depending on the type of hose used and the geometry of the coupling.

Code	Range	s + 0.1	a + 0.3 -0.02	b	Max Torque	Max Pressure
50-W212-027	16-27 mm	0.8	12.2	18	4.2 Nm	45 Bar
50-W212-032	20-32 mm	0.8	12.2	18	5.2 Nm	45 Bar
50-W212-040	25-40 mm	0.8	12.2	18	5.2 Nm	40 Bar
50-W212-045	30-45 mm	0.8	12.2	18	5.2 Nm	35 Bar
50-W212-050	32-50 mm	0.8	12.2	18	6.0 Nm	35 Bar
50-W212-060	40-60 mm	0.8	12.2	18	6.0 Nm	30 Bar
50-W212-070	50-70 mm	0.8	12.2	18	6.8 Nm	25 Bar
50-W212-080	60-80 mm	0.8	12.2	18	6.8 Nm	20 Bar
50-W212-090	70-90 mm	0.8	12.2	18	6.8 Nm	17 Bar
50-W212-100	80-100 mm	0.8	12.2	18	6.8 Nm	14 Bar
50-W212-110	90-110 mm	0.8	12.2	18	6.8 Nm	12 Bar
50-W212-120	100-120 mm	0.8	12.2	18	6.8 Nm	10 Bar
50-W212-130	110-130 mm	0.8	12.2	18	6.8 Nm	8 Bar
50-W212-140	120-140 mm	0.8	12.2	18	6.8 Nm	7 Bar
50-W212-150	130-150 mm	0.8	12.2	18	6.8 Nm	6 Bar
50-W212-160	140-160 mm	0.8	12.2	18	6.8 Nm	5 Bar
50-W212-170	150-170 mm	0.8	12.2	18	6.8 Nm	4 Bar
50-W212-180	160-180 mm	0.8	12.2	18	6.8 Nm	3 Bar
50-W212-190	170-190 mm	0.8	12.2	18	6.8 Nm	2 Bar
50-W212-200	180-200 mm	0.8	12.2	18	6.8 Nm	2 Bar
50-W212-210	190-210 mm	0.8	12.2	18	6.8 Nm	1.8 Bar
50-W212-220	200-220 mm	0.8	12.2	18	6.8 Nm	1.8 Bar
50-W212-230	210-230 mm	0.8	12.2	18	6.8 Nm	1.6 Bar
50-W212-240	220-240 mm	0.8	12.2	18	6.8 Nm	1.6 Bar

W2 Materials

Screw:

Qst 36-3 Mild steel
(DIN 1.0213)
Silver-white Cr3 Zinc Plated

Band and Housing:

X6Cr17 Stainless steel
(DIN 1.4016) (AISI-430)

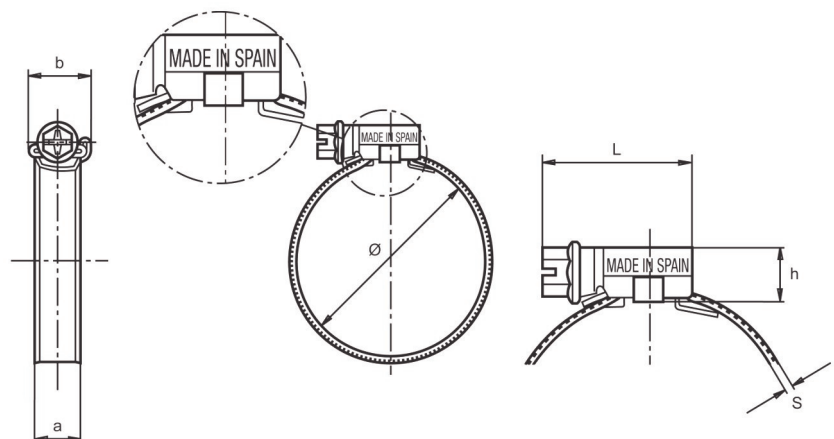

Worm Drive Clamps (Category 50)



**ASFA-L W4 Clamps
9mm Band Width
Full Stainless Steel**

Thanks to the exclusive design of the housing, the ASFA-L W4 hose clip has excellent performance while being at the same time very compact. The cold formed stamped band thread, smoothed on the underside, combined with bevelled band-edges protects the hose from damage.

The ASFA-L W4 hose clip complies fully with the DIN 3017 norm and also with the RoH's directive EU 20032/95/EC dated 1st July 2006.

This clip is ideally for use in the marine industry, due to the corrosion resistance offered by the use of AISI-304 stainless steel in its manufacture.

*The maximum application pressure can vary depending on the type of hose used and the geometry of the coupling.

Code	Range	s + 0.1	a + 0.3 -0.02	b	Max Torque	Max Pressure
50-W409-012	8-12 mm	0.6	7.5	11.5	1.5 Nm	40 Bar
50-W409-016	8-16 mm	0.6	9	14	3.0 Nm	45 Bar
50-W409-022	12-22 mm	0.6	9	14	3.0 Nm	45 Bar
50-W409-027	16-27 mm	0.7	9	14	3.5 Nm	42 Bar
50-W409-032	20-32 mm	0.7	9	14	3.5 Nm	36 Bar
50-W409-040	25-40 mm	0.7	9	14	4.0 Nm	32 Bar
50-W409-045	30-45 mm	0.7	9	14	4.0 Nm	28 Bar
50-W409-050	32-50 mm	0.7	9	14	4.0 Nm	24 Bar
50-W409-060	40-60 mm	0.7	9	14	4.0 Nm	19 Bar
50-W409-070	50-70 mm	0.7	9	14	4.0 Nm	17 Bar
50-W409-080	60-80 mm	0.7	9	14	4.0 Nm	15 Bar
50-W409-090	70-90 mm	0.7	9	14	4.0 Nm	13 Bar
50-W409-100	80-100 mm	0.7	9	14	4.0 Nm	11 Bar
50-W409-110	90-110 mm	0.7	9	14	4.0 Nm	10 Bar
50-W409-120	100-120 mm	0.7	9	14	4.0 Nm	9 Bar
50-W409-130	110-130 mm	0.7	9	14	4.0 Nm	8 Bar
50-W409-140	120-140 mm	0.7	9	14	4.0 Nm	7 Bar
50-W409-150	130-150 mm	0.7	9	14	4.0 Nm	6 Bar
50-W409-160	140-160 mm	0.7	9	14	4.0 Nm	5 Bar

W4 Materials

Screw:

AISI-304 Cu (A2) Stainless steel.

Band and Housing:

X5CrNi1810
Stainless steel (DIN 1.4301)
(AISI-304) (A2)

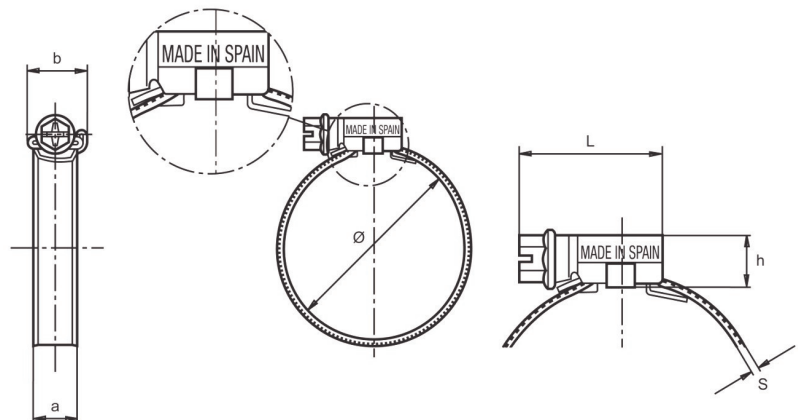

Most Worm drive clamps available with a safety collar to prevent slippage of a screwdriver..

Contact the sales office for further details.

Phone (03) 8770 1333.

Email sales@ifsvic.com.au



Worm Drive Clamps (Category 50)



MIKALOR

**ASFA-S W4 Clamps
12mm Band Width
Full Stainless Steel**

The ASFA-S W4 hose clip combines an innovative housing and a sturdy 12mm band which together make this a high performance hose clip. The cold-formed stamped band thread, smoothed on the underside, combined with bevelled band-edges protects the hose from any damage.

The ASFA-S W4 hose clip complies fully with the DIN 3017 norm and also with the RoH's directive EU 20032/95/EC dated 1st July 2006.

Crafted entirely from AISI-304 stainless steel, this clip is ideally for use in marine applications or in any industrial assemblies where high levels of corrosion resistance are required.

*The maximum application pressure can vary depending on the type of hose used and the geometry of the coupling.

Code	Range	s + 0.1	a + 0.3 -0.02	b	Max Torque	Max Pressure
50-W412-027	16-27 mm	0.8	12.2	18	4.6 Nm	45 Bar
50-W412-032	20-32 mm	0.8	12.2	18	5.6 Nm	45 Bar
50-W412-035	23-35 mm	0.8	12.2	18	5.6 Nm	40 Bar
50-W412-040	25-40 mm	0.8	12.2	18	5.6 Nm	40 Bar
50-W412-045	30-45 mm	0.8	12.2	18	5.6 Nm	35 Bar
50-W412-050	32-50 mm	0.8	12.2	18	6.5 Nm	35 Bar
50-W412-060	40-60 mm	0.8	12.2	18	6.5 Nm	30 Bar
50-W412-070	50-70 mm	0.8	12.2	18	7.0 Nm	25 Bar
50-W412-080	60-80 mm	0.8	12.2	18	7.0 Nm	20 Bar
50-W412-090	70-90 mm	0.8	12.2	18	7.0 Nm	17 Bar
50-W412-100	80-100 mm	0.8	12.2	18	7.0 Nm	14 Bar
50-W412-110	90-110 mm	0.8	12.2	18	7.0 Nm	12 Bar
50-W412-120	100-120 mm	0.8	12.2	18	7.0 Nm	10 Bar
50-W412-130	110-130 mm	0.8	12.2	18	7.0 Nm	8 Bar
50-W412-140	120-140 mm	0.8	12.2	18	7.0 Nm	7 Bar
50-W412-150	130-150 mm	0.8	12.2	18	7.0 Nm	6 Bar
50-W412-160	140-160 mm	0.8	12.2	18	7.0 Nm	5 Bar
50-W412-170	150-170 mm	0.8	12.2	18	7.0 Nm	4 Bar
50-W412-180	160-180 mm	0.8	12.2	18	7.0 Nm	3 Bar
50-W412-190	170-190 mm	0.8	12.2	18	7.0 Nm	2 Bar
50-W412-200	180-200 mm	0.8	12.2	18	7.0 Nm	2 Bar
50-W412-210	190-210 mm	0.8	12.2	18	7.0 Nm	1.8 Bar
50-W412-220	200-220 mm	0.8	12.2	18	7.0 Nm	1.8 Bar
50-W412-230	210-230 mm	0.8	12.2	18	7.0 Nm	1.6 Bar
50-W412-240	220-240 mm	0.8	12.2	18	7.0 Nm	1.6 Bar

W4 Materials

Screw:

AISI-304 Cu (A2) Stainless steel.

Band and Housing:

X5CrNi1810
Stainless steel (DIN 1.4301)
(AISI-304) (A2)

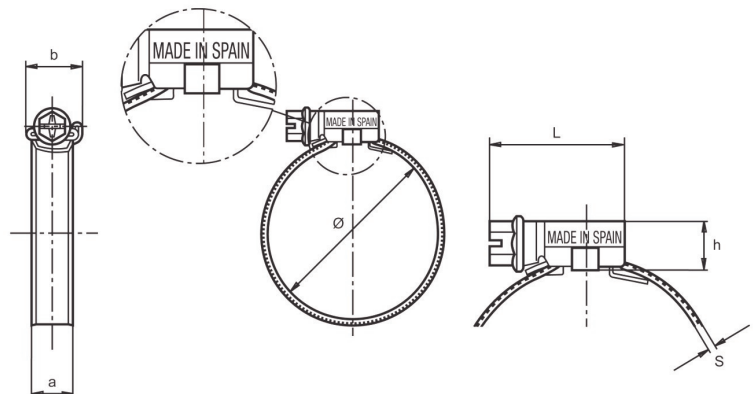

Super Clamps (Category 50)



Mikalor was the first company to design and produce a heavy-duty hose clamp, and since then the Super clamp has gone from strength to strength. The high strength 8.8 grade steel nut and T-bolt mean that Super can be tightened up hard using many different kinds of tool, while the bevelled edges protect the hose from harm.

The Super clamp is in its element in agricultural applications, waste water extraction, mining, quarrying or on other sectors where a rugged yet competitively priced heavy duty clamp is required.

The maximum application pressure can vary depending on the type of hose used and the geometry of the coupling.

Code	Range	r	e	a	b	s	Max Torque	Max Pressure
50-SW1-019	17-19 mm	M5	8	18 +0.2	19.8	0.6	4.5 Nm	48 Bar
50-SW1-022	20-22 mm	M5	8	18 +0.2	19.8	0.6	4.5 Nm	48 Bar
50-SW1-025	23-25 mm	M5	8	18 +0.2	19.8	0.6	4.5 Nm	45 Bar
50-SW1-028	26-28 mm	M5	8	18 +0.2	19.8	0.6	4.5 Nm	45 Bar
50-SW1-031	29-31 mm	M6	10	20 +0.3	22.0	0.8	8 Nm	42 Bar
50-SW1-035	32-35 mm	M6	10	20 +0.3	22.0	0.8	8 Nm	42 Bar
50-SW1-037	34-37 mm	M6	10	20 +0.3	22.0	0.8	8 Nm	40 Bar
50-SW1-039	36-39 mm	M6	10	20 +0.3	22.0	0.8	8 Nm	40 Bar
50-SW1-043	40-43 mm	M6	10	20 +0.3	22.0	0.8	8 Nm	40 Bar
50-SW1-047	44-47 mm	M7	11	22 +0.2	24.5	1.2	16 Nm	44 Bar
50-SW1-051	48-51 mm	M7	11	22 +0.2	24.5	1.2	16 Nm	44 Bar
50-SW1-055	52-55 mm	M7	11	22 +0.2	24.5	1.2	16 Nm	40 Bar
50-SW1-059	56-59 mm	M7	11	22 +0.2	24.5	1.2	16 Nm	40 Bar
50-SW1-063	60-63 mm	M7	11	22 +0.2	24.5	1.2	16 Nm	36 Bar
50-SW1-067	64-67 mm	M7	11	22 +0.2	24.5	1.2	16 Nm	36 Bar
50-SW1-073	68-73 mm	M8	13	24 +0.4	26.5	1.5	25 Nm	28 Bar
50-SW1-079	74-79 mm	M8	13	24 +0.4	26.5	1.5	25 Nm	28 Bar
50-SW1-085	80-85 mm	M8	13	24 +0.4	26.5	1.5	25 Nm	28 Bar
50-SW1-091	86-91 mm	M8	13	24 +0.4	26.5	1.5	25 Nm	20 Bar
50-SW1-097	92-97 mm	M8	13	24 +0.4	26.5	1.5	25 Nm	20 Bar
50-SW1-103	98-103 mm	M8	13	24 +0.4	26.5	1.5	25 Nm	20 Bar
50-SW1-112	104-112 mm	M8	13	24 +0.4	26.5	1.5	25 Nm	12 Bar
50-SW1-121	113-121 mm	M8	13	24 +0.4	26.5	1.5	25 Nm	12 Bar
50-SW1-130	122-130 mm	M8	13	24 +0.4	26.5	1.5	25 Nm	12 Bar
50-SW1-139	131-139 mm	M10	17	26 +0.5	29.0	1.7	50 Nm	9 Bar
50-SW1-148	140-148 mm	M10	17	26 +0.5	29.0	1.7	50 Nm	9 Bar
50-SW1-161	149-161 mm	M10	17	26 +0.5	29.0	1.7	50 Nm	9 Bar
50-SW1-174	162-174 mm	M10	17	26 +0.5	29.0	1.7	50 Nm	6 Bar
50-SW1-187	175-187 mm	M10	17	26 +0.5	29.0	1.7	50 Nm	6 Bar
50-SW1-200	188-200 mm	M10	17	26 +0.5	29.0	1.7	50 Nm	6 Bar
50-SW1-213	201-213 mm	M10	17	26 +0.5	29.0	1.7	50 Nm	3 Bar
50-SW1-226	214-226 mm	M10	17	26 +0.5	29.0	1.7	50 Nm	3 Bar
50-SW1-239	227-239 mm	M10	17	26 +0.5	29.0	1.7	50 Nm	3 Bar
50-SW1-252	240-252 mm	M10	17	26 +0.5	29.0	1.7	50 Nm	3 Bar

W1 Materials

T-Bolt:

8.8 grade steel Yellow zinc plated

Band and Bridge:

Mild steel. Yellow zinc plated.

Washer and Trunions:

Mild steel. Yellow zinc plated

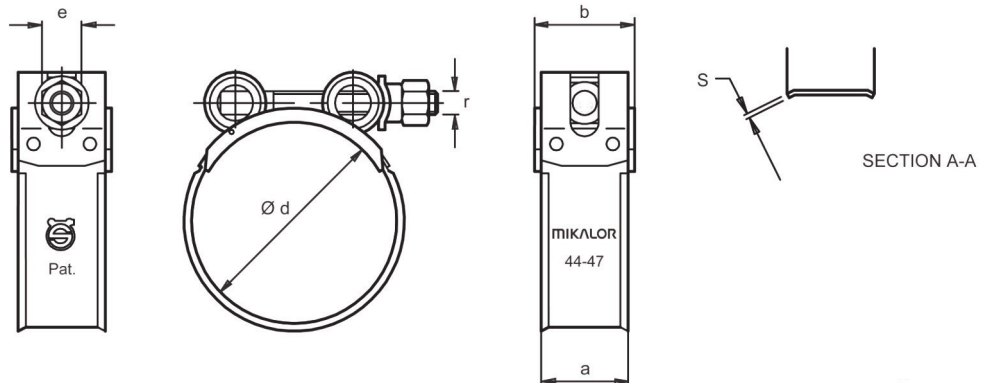

Supra Clamps (Category 50)



W2

MIKALOR

**W2 Stainless Band.
Plated Steel Bolt**

The Supra range is the natural evolution of the Super W1 Clamp. Due to its revolutionary swivelling bridge, Supra W2 can be mounted in the most awkward applications without having to remove the hose. It can be opened up and fastened again when in place without dislodging any other parts of the clamp, making assembly much easier.

Thanks to the bevelled edges, the hose is protected from damage. The Supra W2 clamp complies fully with the RoH's directive EU 20032/95/EC dated 1st July 2006.

The high-strength bolt, designed and manufactured by Mikalor specifically for this clamp, together with the captive nut and spacer system allow you to clamp the most demanding of hose assemblies.

This is the clamp of choice for professionals in the industrial hose, automotive and agricultural machinery sectors as well as in all industrial applications where an outstanding and above all reliable heavy-duty clamp is required.

The maximum application pressure can vary depending on the type of hose used and the geometry of the coupling.

Code	Range	r	e	a	b	Max Torque	Max Pressure
50-SW2-019	17-19 mm	M6	8	18 +0.2	19.8	10 Nm	45 Bar
50-SW2-021	19-21 mm	M6	8	18 +0.2	19.8	10 Nm	45 Bar
50-SW2-023	21-23 mm	M6	8	18 +0.2	19.8	10 Nm	45 Bar
50-SW2-025	23-25 mm	M6	8	18 +0.2	19.8	10 Nm	45 Bar
50-SW2-027	25-27 mm	M6	8	18 +0.2	19.8	10 Nm	45 Bar
50-SW2-029	27-29 mm	M6	8	18 +0.2	19.8	10 Nm	45 Bar
50-SW2-031	29-31 mm	M7	10	20 +0.3	22.0	13 Nm	40 Bar
50-SW2-034	31-34 mm	M7	10	20 +0.3	22.0	13 Nm	40 Bar
50-SW2-037	34-37 mm	M7	10	20 +0.3	22.0	13 Nm	40 Bar
50-SW2-040	37-40 mm	M7	10	20 +0.3	22.0	13 Nm	40 Bar
50-SW2-043	40-43 mm	M7	10	20 +0.3	22.0	13 Nm	40 Bar
50-SW2-047	43-47 mm	M7	10	20 +0.3	22.0	16 Nm	36 Bar
50-SW2-051	47-51 mm	M7	10	20 +0.3	22.0	16 Nm	36 Bar
50-SW2-055	51-55 mm	M7	10	20 +0.3	22.0	16 Nm	36 Bar
50-SW2-059	55-59 mm	M7	10	20 +0.3	22.0	16 Nm	36 Bar
50-SW2-063	59-63 mm	M7	10	20 +0.3	22.0	16 Nm	36 Bar
50-SW2-068	63-68 mm	M7	10	20 +0.3	22.0	16 Nm	36 Bar
50-SW2-073	68-73 mm	M8	13	25 +0.4	27.5	30 Nm	28 Bar
50-SW2-079	73-79 mm	M8	13	25 +0.4	27.5	30 Nm	28 Bar
50-SW2-085	79-85 mm	M8	13	25 +0.4	27.5	30 Nm	28 Bar
50-SW2-091	85-91 mm	M8	13	25 +0.4	27.5	30 Nm	20 Bar
50-SW2-097	91-97 mm	M8	13	25 +0.4	27.5	30 Nm	20 Bar
50-SW2-104	97-104 mm	M8	13	25 +0.4	27.5	30 Nm	20 Bar
50-SW2-112	104-112 mm	M8	13	25 +0.4	27.5	30 Nm	12 Bar
50-SW2-121	112-121 mm	M8	13	25 +0.4	27.5	30 Nm	12 Bar
50-SW2-130	121-130 mm	M8	13	25 +0.4	27.5	30 Nm	12 Bar
50-SW2-140	130-140 mm	M10	15	28 +0.4	31.0	45 Nm	9 Bar
50-SW2-150	140-150 mm	M10	15	28 +0.4	31.0	45 Nm	9 Bar
50-SW2-162	150-162 mm	M10	15	28 +0.4	31.0	45 Nm	9 Bar
50-SW2-174	162-174 mm	M10	15	28 +0.4	31.0	45 Nm	6 Bar
50-SW2-187	174-187 mm	M10	15	28 +0.4	31.0	45 Nm	6 Bar
50-SW2-200	187-200 mm	M10	15	28 +0.4	31.0	45 Nm	6 Bar
50-SW2-213	200-213 mm	M10	15	28 +0.4	31.0	45 Nm	3 Bar
50-SW2-226	213-226 mm	M10	15	28 +0.4	31.0	45 Nm	3 Bar
50-SW2-239	226-239 mm	M10	15	28 +0.4	31.0	45 Nm	3 Bar
50-SW2-252	239-252 mm	M10	15	28 +0.4	31.0	45 Nm	3 Bar
50-SW2-265	252-265 mm	M10	15	28 +0.4	31.0	45 Nm	3 Bar
50-SW2-278	265-278 mm	M10	15	28 +0.4	31.0	45 Nm	3 Bar
50-SW2-291	278-291 mm	M10	15	28 +0.4	31.0	45 Nm	3 Bar
50-SW2-304	291-304 mm	M10	15	28 +0.4	31.0	45 Nm	3 Bar
50-SW2-317	304-317 mm	M10	15	28 +0.4	31.0	45 Nm	3 Bar
50-SW2-330	317-330 mm	M10	15	28 +0.4	31.0	45 Nm	3 Bar
50-SW2-343	330-343 mm	M10	15	28 +0.4	31.0	45 Nm	3 Bar
50-SW2-356	343-356 mm	M10	15	28 +0.4	31.0	45 Nm	3 Bar
50-SW2-369	356-369 mm	M10	15	28 +0.4	31.0	45 Nm	3 Bar
50-SW2-382	369-382 mm	M10	15	28 +0.4	31.0	45 Nm	3 Bar

W2 Materials

Bolt:

Qst 36-3 Mild steel
(DIN 1.0213)
Silver-white Cr3 Zinc-Plated

Band and Bridge:

X6Cr17 Stainless steel
(DIN 1.4016) (AISI-430)

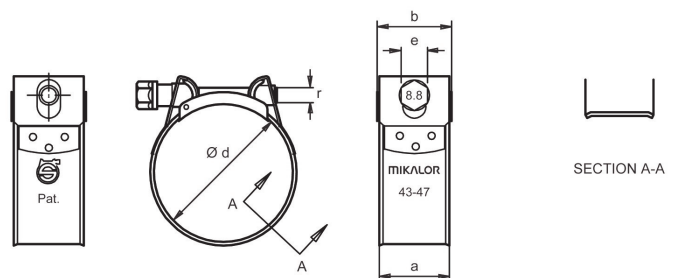

Supra Clamps (Category 50)



W4

The Supra range is the natural evolution of the Super W1 Clamp. Due to its revolutionary swivelling bridge, Supra W4 can be mounted in the most awkward applications without having to remove the hose. It can be opened up and fastened again when in place without dislodging any other parts of the clamp, making assembly much easier. Thanks to the bevelled edges, the hose is protected from damage.

The Supra W4 clamp complies fully with the RoH's directive EU 20032/95/EC dated 1st July 2006.

The stainless steel bolt together with the captive nut and spacer system allow you to clamp the most demanding of hose assemblies.

Supra W4 is a full stainless steel clamp, destined for demanding applications where high corrosion resistance is vital.

This top of the range heavy-duty clamp is ideal for marine applications and the foodstuffs industry, as well as for countless industrial applications where AISI-304 stainless steel is specified.

The maximum application pressure can vary depending on the type of hose used and the geometry of the coupling.

Code	Range	r	e	a	b	Max Torque	Max Pressure
50-SW4-019	17-19 mm	M6	8	18 +0.2	19.8	10 Nm	40 Bar
50-SW4-021	19-21 mm	M6	8	18 +0.2	19.8	10 Nm	40 Bar
50-SW4-023	21-23 mm	M6	8	18 +0.2	19.8	10 Nm	40 Bar
50-SW4-025	23-25 mm	M6	8	18 +0.2	19.8	10 Nm	40 Bar
50-SW4-027	25-27 mm	M6	8	18 +0.2	19.8	10 Nm	40 Bar
50-SW4-029	27-29 mm	M6	8	18 +0.2	19.8	10 Nm	40 Bar
50-SW4-031	29-31 mm	M7	11	20 +0.3	22.0	12 Nm	35 Bar
50-SW4-034	31-34 mm	M7	11	20 +0.3	22.0	12 Nm	35 Bar
50-SW4-037	34-37 mm	M7	11	20 +0.3	22.0	12 Nm	35 Bar
50-SW4-040	37-40 mm	M7	11	20 +0.3	22.0	12 Nm	35 Bar
50-SW4-043	40-43 mm	M7	11	20 +0.3	22.0	12 Nm	35 Bar
50-SW4-047	43-47 mm	M7	11	20 +0.3	22.0	12 Nm	35 Bar
50-SW4-051	47-51 mm	M7	11	20 +0.3	22.0	16 Nm	30 Bar
50-SW4-055	51-55 mm	M7	11	20 +0.3	22.0	16 Nm	30 Bar
50-SW4-059	55-59 mm	M7	11	20 +0.3	22.0	16 Nm	30 Bar
50-SW4-063	59-63 mm	M7	11	20 +0.3	22.0	16 Nm	30 Bar
50-SW4-068	63-68 mm	M7	11	20 +0.3	22.0	16 Nm	30 Bar
50-SW4-073	68-73 mm	M8	13	25 +0.4	27.5	30 Nm	20 Bar
50-SW4-079	73-79 mm	M8	13	25 +0.4	27.5	30 Nm	20 Bar
50-SW4-085	79-85 mm	M8	13	25 +0.4	27.5	30 Nm	20 Bar
50-SW4-091	85-91 mm	M8	13	25 +0.4	27.5	30 Nm	15 Bar
50-SW4-097	91-97 mm	M8	13	25 +0.4	27.5	30 Nm	15 Bar
50-SW4-104	97-104 mm	M8	13	25 +0.4	27.5	30 Nm	15 Bar
50-SW4-112	104-112 mm	M8	13	25 +0.4	27.5	30 Nm	10 Bar
50-SW4-121	112-121 mm	M8	13	25 +0.4	27.5	30 Nm	10 Bar
50-SW4-130	121-130 mm	M8	13	25 +0.4	27.5	30 Nm	10 Bar
50-SW4-140	130-140 mm	M10	15	28 +0.4	31.0	45 Nm	6 Bar
50-SW4-150	140-150 mm	M10	15	28 +0.4	31.0	45 Nm	6 Bar
50-SW4-162	150-162 mm	M10	15	28 +0.4	31.0	45 Nm	6 Bar
50-SW4-174	162-174 mm	M10	15	28 +0.4	31.0	45 Nm	3 Bar
50-SW4-187	174-187 mm	M10	15	28 +0.4	31.0	45 Nm	3 Bar
50-SW4-200	187-200 mm	M10	15	28 +0.4	31.0	45 Nm	3 Bar
50-SW4-213	200-213 mm	M10	15	28 +0.4	31.0	45 Nm	3 Bar
50-SW4-226	213-226 mm	M10	15	28 +0.4	31.0	45 Nm	3 Bar
50-SW4-239	226-239 mm	M10	15	28 +0.4	31.0	45 Nm	3 Bar
50-SW4-252	239-252 mm	M10	15	28 +0.4	31.0	45 Nm	3 Bar

W4 Materials

Bolt:
AISI 302 Cu
Stainless Steel

Band and Bridge:
X5CrNi 1810 Stainless steel
(DIN 1.4301) (AISI-304) (A2)

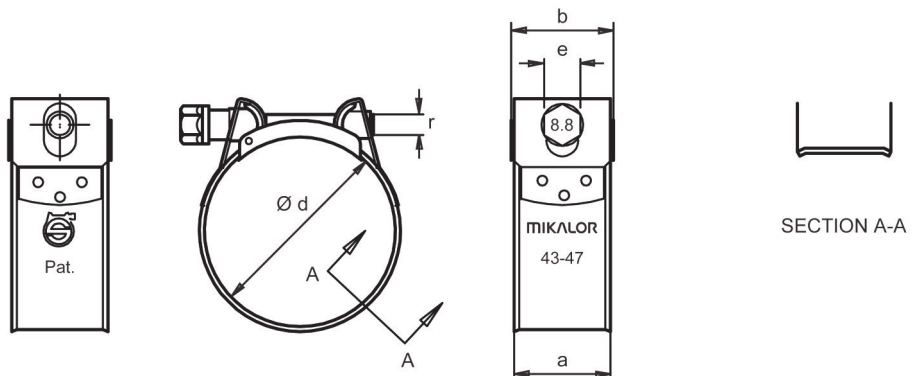

Terry Tool Clips (Category 50)

Closed Type Tool Clip



Terry Tool Clips are produced in high quality zinc plated spring steel. Frequently used in the Hardware and DIY market sectors

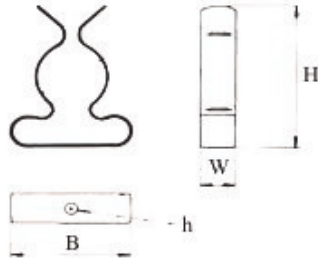

Code	Range	H (mm)	W (mm)	B (mm)	h (mm)
50-TTC06	6-7 mm	15.3	6.35	12.9	2.4
50-TTC10	10-12 mm	20.0	6.35	15.5	2.4
50-TTC13	13-14 mm	26.4	7.94	20.1	3.2
50-TTC16	16-19 mm	32.2	7.94	22.6	3.2
50-TTC19	19-21 mm	36.4	7.94	25.3	3.2
50-TTC25	25-27 mm	40.3	9.52	28.8	3.2
50-TTC28	28-31 mm	48.7	9.52	34.1	3.6
50-TTC32	32-34 mm	59.3	11.11	42.8	3.6
50-TTC38	38-40 mm	67.0	12.70	49.5	4.0*
50-TTC51	51-54 mm	80.2	12.70	53.0	4.0*

* Larger sizes have 2 mount holes

Open Type Tool Clip



The Open type tool clip allows an easier entry or withdrawal of the item being secured.

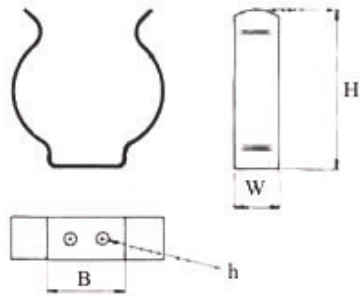

Code	Range	H (mm)	W (mm)	B (mm)	h (mm)
50-TTO06	6-7 mm	10.5	6.35	3.8	2.4
50-TTO10	10-12 mm	13.3	6.35	4.3	2.4
50-TTO13	13-14 mm	16.1	7.94	5.0	2.4
50-TTO16	16-19 mm	20.5	7.94	6.5	2.4
50-TTO19	19-21 mm	26.6	9.52	9.0	3.2
50-TTO25	25-27 mm	30.0	9.52	10.2	3.2
50-TTO28	28-31 mm	33.4	11.11	12.0	3.6
50-TTO32	32-34 mm	39.0	11.11	12.0	3.2
50-TTO38	38-40 mm	48.0	12.70	13.0	3.2
50-TTO51	51-54 mm	61.3	12.70	19.5	3.6*

* Larger sizes have 2 mount holes

Open Type Super Clip

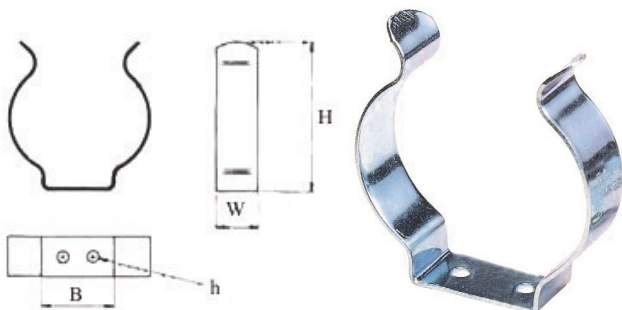

Code	Range	H (mm)	W (mm)	B (mm)	h (mm)
50-TSC044	44-46 mm	53.4	12.7	25.5	4.00
50-TSC064	64-67 mm	75.5	19.1	35.5	4.90
50-TSC076	76-79 mm	87.5	19.1	47.0	4.75
50-TSC089	89-93 mm	101.6	22.2	48.0	4.75
50-TSC102	102-106 mm	117.5	25.4	57.2	4.75

The SUPER CLIP is a Heavy Duty Open style Tool Clip, designed for large object up to 106mm diameter. All Super Clips have 2 mount holes.



Other styles of clamps also available.
 Contact the sales office for further details. Phone (03) 8770 1333.
 Email sales@ifsvic.com.au



Brass Hose Ferrules (Category 50)



For use with general purpose barbed hose tails.





The correct I.D. should not exceed 0.8mm (1/32")
above the hose O.D. With the tail inserted.





Other sizes and materials also available.
Contact the sales office for any other requirements.







I.F.S. Code	Industrial Code	ID		Length		Hole		Thickness	
		(in)	(mm)	(in)	(mm)	(in)	(mm)	(in)	(mm)
50-BFL0380	622	.380	9.65	.500	12.70	.265	6.73	.020	0.51
50-BFL0410	620	.410	10.41	.500	12.70	.265	6.73	.020	0.51
50-BFL0450	769	.450	11.43	.562	14.27	.343	8.71	.020	0.51
50-BFM0478	4750	.478	12.14	.687	17.45	.328	8.33	.025	0.64
50-BFL0500	624	.500	12.70	.500	12.70	.343	8.71	.020	0.51
50-BFM0500	7322	.500	12.70	1.000	25.40	.343	8.71	.025	0.64
50-BFL0525	625	.525	13.34	.470	11.94	.360	9.14	.020	0.51
50-BFM0525	7323	.525	13.34	1.000	25.40	.375	9.53	.025	0.64
50-BFL0550		.550	13.97	.484	12.29	.375	9.53	.020	0.51
50-BFM0562	7325	.560	14.22	1.000	25.40	.437	11.10	.025	0.64
50-BFL0575	KK	.575	14.61	.484	12.29	.468	11.89	.020	0.51
50-BFM0593	7326	.593	15.06	1.000	25.40	.437	11.10	.025	0.64
50-BFL0600	JJ	.600	15.24	.500	12.70	.500	12.70	.020	0.51
50-BFL0625	II	.625	15.88	.500	12.70	.500	12.70	.020	0.51
50-BFM0625	7327	.625	15.88	1.000	25.40	.437	11.10	.025	0.64
50-BFL0650	HH	.650	16.51	.500	12.70	.500	12.70	.020	0.51
50-BFM0656	7328	.656	16.66	1.000	25.40	.437	11.10	.025	0.64
50-BFM0675	GG	.675	17.15	.500	12.70	.500	12.70	.025	0.64
50-BFM0687	7329	.690	17.53	1.000	25.40	.500	12.70	.025	0.64
50-BFM0718B	7330B	.718	18.24	1.000	25.40	.500	12.70	.025	0.64
50-BFM0718	7330	.718	18.24	1.000	25.40	.625	15.88	.025	0.64
50-BFL0725	EE	.725	18.42	.530	13.46	.500	12.70	.020	0.51
50-BFL0750	DD	.750	19.05	.531	13.49	.500	12.70	.020	0.51
50-BFM0750B	7331B	.750	19.05	1.000	25.40	.500	12.70	.025	0.64
50-BFM0750	7331	.750	19.05	1.000	25.40	.625	15.88	.025	0.64
50-BFM0781B	7332B	.781	19.84	1.000	25.40	.500	12.70	.025	0.64
50-BFM0781	7332	.781	19.84	1.000	25.40	.625	15.88	.025	0.64
50-BFM0850		.850	21.59	.968	24.59	.593	15.06	.025	0.64
50-BFM0875	7244A	.875	22.23	.843	21.41	.687	17.45	.025	0.64
50-BFM0900	5029A	.900	22.86	.875	22.23	.687	17.45	.025	0.64
50-BFM0975	5028A	.975	24.77	.843	21.41	.687	17.45	.025	0.64
50-BFM1025	7114A	1.025	26.04	.843	21.41	.687	17.45	.025	0.64
50-BFM1050	7145A	1.050	26.67	.843	21.41	.687	17.45	.025	0.64
50-BFM1100	5027A	1.100	27.94	.843	21.41	.812	20.62	.025	0.64
50-BFM1175	7088A	1.175	29.85	.875	22.23	.875	22.23	.025	0.64
50-BFM1225		1.225	31.12	.968	24.59	.875	22.23	.025	0.64
50-BFM1275		1.275	32.39	.968	24.59	.875	22.23	.025	0.64
50-BFM1380		1.380	35.05	.843	21.41	1.047	26.59	.025	0.64
50-BFM1500	1500	1.500	38.10	.875	22.23	1.125	28.58	.025	0.64
50-BFM1550	1550	1.550	39.37	.812	20.62	1.125	28.58	.025	0.64

Grease Nipples (Category 54)





BSP STANDARD HEAD GREASE NIPPLES				
Size & Description	 Straight	 45 Degree	 67.5 Degree	 90 Degree
1/8 Plated Steel	54-B02	54-B02-45	54-B02-67	54-B02-90
1/8 Stainless Steel	54-BSS02	54-BSS02-45		54-BSS02-90
1/4 Plated Steel	54-B04	54-B04-45	54-B04-67	54-B04-90
1/4 Stainless Steel	54-BSS04	54-BSS04-45		54-BSS04-90

BSF STANDARD HEAD GREASE NIPPLES				
Size & Description	 Straight	 45 Degree	 67.5 Degree	 90 Degree
1/4 Plated Steel	54-F04	54-F04-45	54-F04-67	54-F04-90
1/4 Stainless Steel	54-FSS04			
5/16 Plated Steel	54-F05	54-F05-45	54-F05-67	54-F05-90
3/8 Plated Steel	54-F06	54-F06-45	54-F06-67	54-F06-90





NPT STANDARD HEAD GREASE NIPPLES				
Size & Description	 Straight	 45 Degree	 67.5 Degree	 90 Degree
1/8 Plated Steel	54-N02	54-N02-45	54-N02-67	54-N02-90
1/8 Stainless Steel	54-NSS02	54-NSS02-30	54-NSS02-67	54-NSS02-90
1/4 Plated Steel	54-N04	54-N04-45	54-N04-67	54-N04-90

Grease Nipples (Category 54)

BSW (WHITWORTH) STANDARD HEAD GREASE NIPPLES





Size & Description	 Straight	 45 Degree	 67.5 Degree	 90 Degree
1/4 Plated Steel	54-W04	54-W04-45	54-W04-67	54-W04-90
1/4 Stainless Steel	54-WSS04	54-WSS04-45		54-WSS04-90
5/16 Plated Steel	54-W05			
1/2 Plated Steel		54-W08-35		

METRIC STANDARD HEAD GREASE NIPPLES

Size & Description	 Straight	 45 Degree	 67.5 Degree	 90 Degree
M5x0.8 Plated Steel	54-M0508			
M6x0.75 Plated Steel	54-M0607			
M6x1 Plated Steel	54-M0610	54-M0610-45		54-M0610-90
M6x1 Stainless Steel	54-MSS0610	54-MSS0610-45		54-MSS0610-90
M8x1 Plated Steel	54-M0810	54-M0810-45	54-M0810-67	54-M0810-90
M8x1 Stainless Steel	54-MSS0810	54-MSS0810-45		54-MSS0810-90
M8x1.25 Plated Steel	54-M0812	54-M0812-45	54-M0812-67	54-M0812-90
M8x1.25 Stainless Steel	54-MSS0812			
M10x1 Plated Steel	54-M1010	54-M1010-45		54-M1010-90
M10x1 Stainless Steel	54-MSS1010	54-MSS1010-45		54-MSS1010-90
M10x1.5 Plated Steel	54-M1015	54-M1015-45		54-M1015-90
M12x1.5 Plated Steel				54-M1215-90

Grease Nipples (Category 54)

UNF (SAE) STANDARD HEAD GREASE NIPPLES

Size & Description				
	Straight	45 Degree	67.5 Degree	90 Degree
1/4 Plated Steel	54-U04	54-U04-45	54-U04-67	54-U04-90
1/4 Stainless Steel	54-USS04	54-USS04-45		54-USS04-90
5/16 Plated Steel	54-U05	54-U05-45	54-U05-67	54-U05-90
3/8 Plated Steel	54-U06	54-U06-45	54-U06-67	54-U06-90



DRIVE FIT STANDARD HEAD GREASE NIPPLES

Code	Size and Description
54-D02	1/8 Straight
54-D03	3/16 Straight
54-D03-45	3/16 45 Degree
54-D03-65	3/16 65 Degree
54-D04	1/4 Straight
54-D04-45	1/4 45 Degree
54-D04-65	1/4 65 Degree
54-D05	5/16 Straight
54-D05-35	5/16 35 Degree
54-D05-65	5/16 65 Degree
54-DNB03	3/16 Straight - No Ball
54-DNB04	1/4 Straight - No Ball
54-DNB05	5/16 Straight - No Ball
54-DSS04	1/4 S/Steel Straight
54-MD06	6mm Straight
54-MD08	8mm Straight



LONG STANDARD HEAD GREASE NIPPLES

Code	Size and Description
54-FL04-15	1/4 BSF x 15/16 Long
54-ML0610-29	M6x1 x 29mm Long
54-NL02-20	1/8 NPT x 1.1/4 Long
54-NL02-42	1/8 NPT x 2.5/8 Long
54-UL04-11	1/4 UNF x 11/16 Long
54-UL04-15	1/4 UNF x 15/16 Long
54-UL04-18	1/4 UNF x 1.1/8 Long
54-UL04-23	1/4 UNF x 1.7/16 Long
54-UL04-25	1/4 UNF x 1.39/64 Long
54-UL04-26	1/4 UNF x 1.5/8 Long

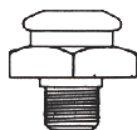

INDUSTRIAL ROUND HEAD GREASE NIPPLES

Code	Size and Description
54-BIR02	1/8 BSP
54-BIR04	1/4 BSP
54-BIR06	3/8 BSP



HEX BUTTON HEAD GREASE NIPPLES

Code	Size and Description
54-BHB02	1/8 BSP
54-BHB04	1/4 BSP
54-FHB04	1/4 BSF
54-FHB06	3/8 BSF
54-NHB02	1/8 NPT
54-NHB04	1/4 NPT
54-UHB04	1/4 UNF

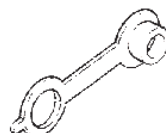

GREASE NIPPLE DUST COVER

Code 54-12833

Oil Nipples (Category 55)

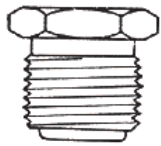

HEX HEAD OIL NIPPLE

Code	Thread
55-BH02	1/8 BSP
55-BH04	1/4 BSP
55-MH0610	M6x1
55-MH0810	M8x1
55-NH06	3/8 NPT
55-NH08	1/2 NPT
55-NH12	3/4 NPT
55-UH04	1/4 UNF



SCREWDRIVER SLOT OIL NIPPLE

Code	Thread
55-B02	1/8 BSP
55-N02	1/8 NPT
55-N04	1/4 NPT
55-U04	1/4 UNF



DRIVE FIT OIL NIPPLE

Code	Size
55-D02	1/8
55-D03	3/16
55-D04	1/4
55-D05	5/16
55-MD06	6mm
55-MD08	8mm
55-MD10	10mm

Lubrication Equipment (Category 56)

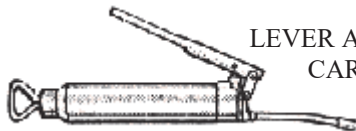

LEVER ACTION GREASE GUN. CARTIDGE OR BULK

Code	Size
56-GG400L	400g
56-GG450L	450g

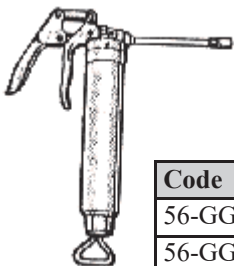

TRIGGER ACTION GREASE GUN. CARTIDGE OR BULK

Code	Size
56-GG400T	400g
56-GG450T	450g



GREASE GUN COUPLER

Code	Description
56-GGC14	Slimline. 14mm Dia. 3 Jaw.
56-GGC16	Standard. 16mm Dia. 4 Jaw.
56-GGC18	Heavy Duty. 18mm Dia.

RIGID GREASE GUN EXTENSION



Code	Description
56-GGER	Bent pipe c/w Locknut

FLEXIBLE GREASE GUN EXTENSIONS SINGLE WIRE BRAID



Code	Length
56-GGE08	8"
56-GGE10	10"
56-GGE12	12"
56-GGE15	15"
56-GGE18	18"
56-GGE24	24"
56-GGE28	28"

Assortment Kits (Category 64)

Olive Assortments



Code : 64-OL1
Type 100 Universal Olives
Imperial 1/8" to 1/2"
Metric 4mm to 12mm

CONTENTS		
Code	Description	Qty
01--102	No 100 1/8 Universal Olive	10
01--103	No 100 3/16 Universal Olive	10
01--104	No 100 1/4 Universal Olive	10
01--105	No 100 5/16 Universal Olive	10
01--106	No 100 3/8 Universal Olive	10
01--108	No 100 1/2 Universal Olive	10
32-M.10004	M100 4mm Universal Olive	10
32-M.10005	M100 5mm Universal Olive	10
32-M.10006	M100 6mm Universal Olive	10
32-M.10008	M100 8mm Universal Olive	10
32-M.10010	M100 10mm Universal Olive	10
32-M.10012	M100 12mm Universal Olive	10

Code : 64-OL2
Type 1 Metallic Tube Olives
Imperial 1/8" to 1/2"
Metric 4mm to 12mm

CONTENTS		
Code	Description	Qty
01-.101	No 1 1/8 Standard Olive	10
01-.102	No 1 3/16 Standard Olive	10
01-.103	No 1 1/4 Standard Olive	10
01-.104	No 1 5/16 Standard Olive	10
01-.105	No 1 3/8 Standard Olive	10
01-.107	No 1 1/2 Standard Olive	10
32-M.104	M1 4mm Standard Olive	10
32-M.105	M1 5mm Standard Olive	10
32-M.106	M1 6mm Standard Olive	10
32-M.108	M1 8mm Standard Olive	10
32-M.110	M1 10mm Standard Olive	10
32-M.112	M1 12mm Standard Olive	10

Code : 64-OL3
Imperial Tube Olives
Type 1 and 100
Sizes 1/8" to 1/2"

CONTENTS		
Code	Description	Qty
01--102	No 100 1/8 Universal Olive	10
01--103	No 100 3/16 Universal Olive	10
01--104	No 100 1/4 Universal Olive	10
01--105	No 100 5/16 Universal Olive	10
01--106	No 100 3/8 Universal Olive	10
01--108	No 100 1/2 Universal Olive	10
01-.101	No 1 1/8 Standard Olive	10
01-.102	No 1 3/16 Standard Olive	10
01-.103	No 1 1/4 Standard Olive	10
01-.104	No 1 5/16 Standard Olive	10
01-.105	No 1 3/8 Standard Olive	10
01-.107	No 1 1/2 Standard Olive	10

Code : 64-OL4
Metric Tube Olives
Type 1 and 100
Sizes 4mm to 12mm

CONTENTS		
Code	Description	Qty
32-M.10004	M100 4mm Universal Olive	10
32-M.10005	M100 5mm Universal Olive	10
32-M.10006	M100 6mm Universal Olive	10
32-M.10008	M100 8mm Universal Olive	10
32-M.10010	M100 10mm Universal Olive	10
32-M.10012	M100 12mm Universal Olive	10
32-M.104	M1 4mm Standard Olive	10
32-M.105	M1 5mm Standard Olive	10
32-M.106	M1 6mm Standard Olive	10
32-M.108	M1 8mm Standard Olive	10
32-M.110	M1 10mm Standard Olive	10
32-M.112	M1 12mm Standard Olive	10

Note : All Assortment Kits can be customised to you needs, including the contents and your own Name and Logo.

Contact the office for any custom requirements.

Assortment Kits (Category 64)

Double Ear Clamp Assortments

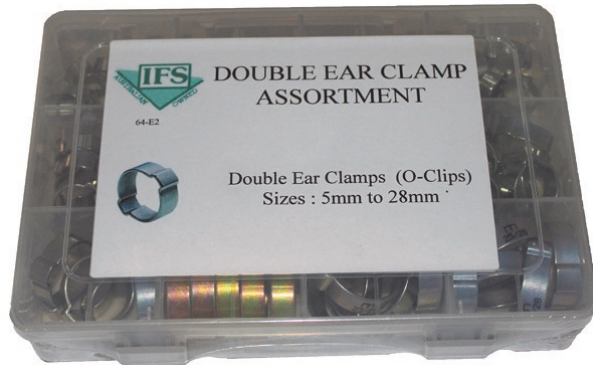

Code : 64-E2
Double Ear Clamps (O-Clips)
Sizes 5mm to 28mm

CONTENTS		
Code	Description	Qty
50-E2-0507	5-7mm (1/4) Z/P Steel Double Ear Clamp	10
50-E2-0709	7-9mm (5/16) Z/P Steel Double Ear Clamp	10
50-E2-0911	9-11mm (7/16) Z/P Steel Double Ear Clamp	10
50-E2-1113	11-13mm (1/2) Z/P Steel Double Ear Clamp	10
50-E2-1315	13-15mm (9/16) Z/P Steel Double Ear Clamp	10
50-E2-1417	14-17mm (19/32) Z/P Steel Double Ear Clamp	10
50-E2-1518	15-18mm (5/8) Z/P Steel Double Ear Clamp	10
50-E2-1720	17-20mm (3/4) Z/P Steel Double Ear Clamp	8
50-E2-2023	20-23mm (7/8) Z/P Steel Double Ear Clamp	5
50-E2-2225	22-25mm (15/16) Z/P Steel Double Ear Clamp	5
50-E2-2327	23-27mm (1") Z/P Steel Double Ear Clamp	4
50-E2-2528	25-28mm (1.1/16) Z/P Steel Double Ear Clamp	4

Code : 64-EP2
Double Ear Clamps (O-Clips)
Sizes 5mm to 28mm with Pincer

CONTENTS		
Code	Description	Qty
50-E2-0507	5-7mm (1/4) Z/P Steel Double Ear Clamp	10.00
50-E2-0709	7-9mm (5/16) Z/P Steel Double Ear Clamp	10.00
50-E2-0911	9-11mm (7/16) Z/P Steel Double Ear Clamp	10.00
50-E2-1113	11-13mm (1/2) Z/P Steel Double Ear Clamp	10.00
50-E2-1315	13-15mm (9/16) Z/P Steel Double Ear Clamp	10.00
50-E2-1417	14-17mm (19/32) Z/P Steel Double Ear Clamp	10.00
50-E2-1518	15-18mm (5/8) Z/P Steel Double Ear Clamp	10.00
50-E2-1720	17-20mm (3/4) Z/P Steel Double Ear Clamp	10.00
50-E2-2023	20-23mm (7/8) Z/P Steel Double Ear Clamp	5.00
50-E2-2225	22-25mm (15/16) Z/P Steel Double Ear Clamp	5.00
50-E2-2327	23-27mm (1") Z/P Steel Double Ear Clamp	5.00
50-E2-2528	25-28mm (1.1/16) Z/P Steel Double Ear Clamp	5.00
50-ECPI099	Ear Clamp Pincers - Side & Top Join	1.00

Code : 64-ES2
Stainless Steel Double Ear Clamps (O-Clips)
Sizes 5mm to 28mm

CONTENTS		
Code	Description	Qty
50-ES2-0709	7-9mm (5/16) S/Steel Double Ear Clamp	10.00
50-ES2-0911	9-11mm (7/16) S/Steel Double Ear Clamp	10.00
50-ES2-1113	11-13mm (1/2) S/Steel Double Ear Clamp	10.00
50-ES2-1315	13-15mm (9/16) S/Steel Double Ear Clamp	10.00
50-ES2-1518	15-18mm (5/8) S/Steel Double Ear Clamp	10.00
50-ES2-1720	17-20mm (3/4) S/Steel Double Ear Clamp	10.00
50-ES2-2023	20-23mm (7/8) S/Steel Double Ear Clamp	6.00
50-ES2-2327	23-27mm (1") S/Steel Double Ear Clamp	4.00
50-ES2-2528	25-28mm (1.1/16) S/Steel Double Ear Clamp	6.00
50-ES2-2831	28-31mm (1.3/16) S/Steel Double Ear Clamp	4.00

Note : Assortment Kits can be customised to you needs, including your own Name and Logo

Assortment Kits (Category 64)

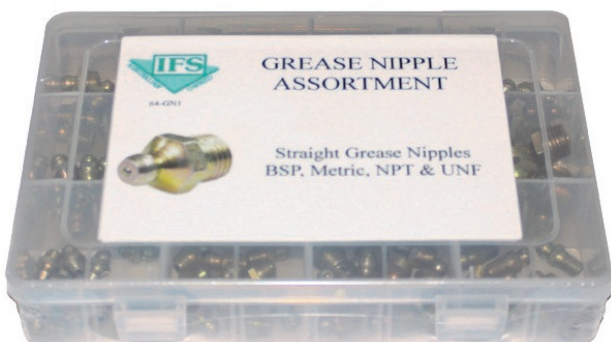

Code : 64-GN1
Straight Grease Nipples
BSP, Metric, NPT and UNF Threads

Contents

Code	Description	Qty
54-B02	1/8 BSP Straight Grease Nipple	10
54-B04	1/4 BSP Straight Grease Nipple	10
54-M0610	M6x1 Straight Grease Nipple	10
54-M0810	M8x1 Straight Grease Nipple	10
54-M0812	M8x1.25 Straight Grease Nipple	10
54-M1010	M10x1 Straight Grease Nipple	10
54-N02	1/8 NPT Straight Grease Nipple	10
54-N04	1/4 NPT Straight Grease Nipple	10
54-U04	1/4 UNF Straight Grease Nipple	10
54-U05	5/16 UNF Straight Grease Nipple	10
54-U06	3/8 UNF Straight Grease Nipple	10
54-UL04-11	1/4 UNF Straight Grease Nipple - 11/16 Long	10

Note : Assortment Kits can be customised to you needs, including your own Name and Logo

Imperial Tools (Category 65)

TUBE CUTTERS

For hard or soft copper, aluminium, brass, thin wall steel, stainless steel and other tubing

65-TC1000 & 65-TC1010 Heavy Duty Tube Cutters For 1/8" to 1-1/8" O.D. Tube

- Enclosed hardened steel thrust bearing feed mechanism for smooth cutting action
- Imperial's unique design eliminates spiraling for clean right angle cuts.
- Nickel plated aluminum body
- Foldaway hardened steel reamer removes inside burrs cleanly. Filing surface removes outside burrs
- Cutter wheels are made of the highest quality wear and abrasion resistant chromium steel and precision machined for accurate cutting and long life
- Includes 2 cutting wheels. One spare is carried under the fold out the retractable reamer

Other models include the:

65-TC1020 - a combination cutter and tube restrictor for soldering.



The **65-TC1010** is specifically designed for the rigours of cutting Stainless Steel, monel and other hard temper tubing.

65-TC1550 Heavy Duty Tube Cutter **NEW!!** For 1/8" to 1-1/8" O.D. Tube

- Imperial's newest tube cutter!
- Lower profile swing radius - 4.1/4"
- Retractable rotary style reamer
- Lightweight die cast aluminum body
- Enclosed hardened steel thrust bearing feed mechanism for smooth cutting action
- Imperial's unique design eliminates spiraling for clean right angle cuts.
- Cutter wheels are made of the highest quality wear and abrasion resistant chromium steel and precision machined for accurate cutting and long life
- Includes 2 cutting wheels



**** Available in clamshell packaging ****

Imperial Tools (Category 65)

TUBE CUTTERS

For hard or soft copper, aluminium, brass, thin wall steel, stainless steel and other tubing

65-TC1050 Mini Tube Cutter

For 1/8" to 5/8" O.D. Tube

- Designed for use in tight quarters where other tube cutters won't fit
- 1.1/4" swing radius
- Enclosed feed screw minimizes contamination assuring continued smooth operation
- Corrosion resistant steel rollers positioned at bottom of cutter allow for easier cutter engagement on tubing and smoother cutting action

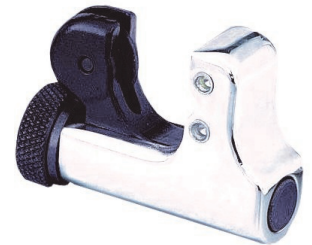

65-TC1050RH Ratcheting Tube Cutter **NEW!!**

For 1/8" to 5/8" O.D. Tube

- Includes the TC1050 mini tube cutter which can easily be removed from the handle
- Six independent drive pawls provide a 15" arc swing
- Lifetime warranty
- Available in clamshell packaging



LARGER CAPACITY TUBE CUTTERS

65-TC174F Tube Cutter

For 3/8" to 1-1/8" O.D. Tube

- Small swing radius - 1.15/16"
- Includes 2 general purpose cutting wheels



65-TC312FC Tube Cutter

For 1/4" to 1-5/8" O.D. Tube

- Larger version of the TC1000 with the same specifications
- Includes 2 general purpose cutting wheels



65-TC206FBP Tube Cutter

For 3/8" to 2-5/8" O.D. Tube

- Ratchet feed mechanism speeds up cutting operation
- Extra wide flare cut off groove in rollers to accommodate flares on larger size tubing
- Includes a spare cutter wheel to cut schedule 40 PVC pipe up to 2"



Imperial Tools (Category 65)

TUBE CUTTERS

For hard or soft copper, aluminium, brass, thin wall steel, stainless steel and other tubing

DEBURRING TOOLS

65-210F Deburring Tool - The rotary style blade is perfect for removing burs from holes and edges. Internal storage cavity to store spare blades. Supplied with one spare blade. Suitable for copper, steel, aluminum, cast iron, brass and plastic tubing.



65-208F Reaming and Deburring Tool - Reams both inside and outside of tube. Deburrs clockwise and anti clockwise. Suitable for copper, aluminium and brass tube.

65-208FSS Reaming and Deburring Tool - Reamer for stainless steel tubing, hard or soft copper, aluminium, brass and steel tubing. Tungsten hardened steel cutter blades.



SPARE PARTS

Cutting Wheels

65-TC1000B - General purpose cutting wheel
Suits the TC1000, TC1550, TC312FC and the TC174F

65-TC1010B - Wheel for continuous cutting of stainless steel, monel and other hard temper tubing
Suits the TC1010, TC1000, TC1550, TC312FC and the TC174F

65-TC1020B - Constrictor wheel for producing sweat joints
Suits the TC1020

65-TC1050B - General purpose cutting wheel
Suits the TC1050

65-S74761 - General purpose cutting wheel
Suits the TC206FBP

65-S10000770 - Cutting wheel for PVC pipe
Suits the TC206FBP

Deburring Blades

65-S10001087 - Deburring replacement blade
Suits the TC1550 tube cutter and the 210-F deburring tool

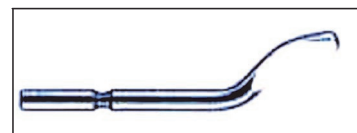

Imperial Tools (Category 65)

TUBE BENDERS

For bending soft copper, aluminum, brass, thin wall steel and thin wall stainless steel

65-470FH Triple Head 180° Tube Bender with Roto-Lok Indexing Handle
Bends 3/16" to 3/8" O.D. Tube

- Patented quick action indexing lever repositions two-stage handle midway through bend when both handles begin to meet. This feature allows better control and no crossing of hands when fabricating 180° bends.
- Optimum bend radius for each tube size
- Calibrated markings
- Compact design
- Available in clam shell packaging



Bend to 90°

Move handle to start second bend

Lower handle to complete bend

TUBE O.D.	RADIUS
3/16	7/16
1/4	9/16
5/16	11/16
3/8	15/16

65-370FH Triple Head 180° Tube Bender
Bends 3/16" to 1/2" O.D. Tube

- Makes smooth, tight radius bends
- Calibrated markings
- Available in clam shell packaging

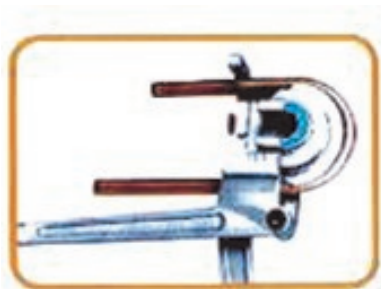

Easy 180° bends in one swift motion

TUBE O.D.	RADIUS
1/4	11/16
3/8	1-1/8
1/2	1-1/2



Imperial Tools (Category 65)

TUBE BENDERS

For bending soft copper, aluminum, brass, thin wall steel and thin wall stainless steel

65-367FH Triple Head Tube Bender

Bends 1/8" to 1/4" O.D. Tube

- For soft copper, aluminium and steel
- Calibrated markings for making accurate left hand, right hand and offset bends
- Ninety degree start requires less effort - making bending fast and easy



65-368FH Triple Head Tube Bender

Bends 3/16" to 3/8" O.D. Tube

- For soft copper, aluminum and steel
- Calibrated markings for making accurate left hand, right hand and offset bends
- Ninety degree start requires less effort - making bending fast and easy



Spring Type Tube Benders

Allow hand bending of soft tubing.

65-101F Set of 6 benders for 1/4", 5/16", 3/8", 7/16", 1/2" and 5/8" O.D. tube. Individual springs also available



SINGLE HEAD TUBE BENDERS

65-364FHA Lever Type Tube Benders

For 1/8" - 1" O.D. Tubing

Also available in metric sizes 6-12 mm

- Each tool bends one size of tube
- Features telescopic handles for increased leverage



65-364FHB Swivel Handle Tube Benders

For 1/4" - 1/2" O.D. Tube

- Each tool bends one size.
- The swivel handle can be repositioned midway through a bend when both handles begin to meet. This feature allows easy fabrication of bends up to 180° with less effort and better control, without the crossing of handles.



Lever type tube bender kits also available. Each tool quickly adapts to all sizes in its range by changing forming wheel and block.

For more information on the complete range of Imperial tube benders available , including gear type benders, please contact our sales staff

Imperial Tools (Category 65)

TUBE BENDERS

For bending soft copper, aluminum, brass, thin wall steel and thin wall stainless steel

SINGLE HEAD TUBE BENDERS

65-270F Series Benders

Available in sizes for 3/8" to 1-1/8" O.D. tubing.

For all bending work. Spur-gear type with 10-to-1 ratio for easy bending of all tempered tubing. Floating shoe aligns tube perfectly on calibrated forming wheel. Pull-pin on wheel speeds repositioning for bends over 90°. Portable. Can be hand held, clamped in vice or bolted to bench.

Code	Tube OD	Radius. Centre to centre of tube	Min return from ctr to ctr of tube	W/Thickness (in)
65-270F-06	3/8"	1.75"	4.5"	.030 to .060
65-270F-08	1/2"	2.5"	6"	.035 to .065
65-270F-10	5/8"	3"	7.5"	.040 to .072
65-270F-12	3/4"	4"	9.5"	.042 to .083
65-270F-14	7/8"	4"	9.5"	.045 to .083
65-270F-16	1"	4"	9.5"	.065 to .095
65-270F-18	1.1/8"	4"	9.5"	.065 to .095

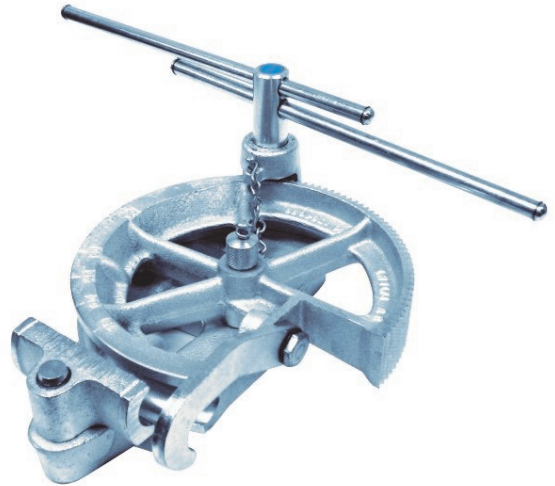

65-664FH Heavy Duty Tube Bender with Roto-Lok Indexing Handles

For 1/4", 3/8" and 1/2" O.D. Tube

Also available for metric sizes 6-12 mm

- New design for accurate and tight bends up to 180° in stainless steel and other tough metals.
- Patented, quick action trigger release repositions two-stage handle midway through a bend when both handles begin to meet. This feature allows easy fabrication of optimised bends up to 180° with reduced effort, better control and no crossing of handles!
- Rollers in bending handle reduce friction and bending effort; eliminate scoring of tubing.
- Comfortable and durable ergonomically moulded cushion grips.
- Vice lug for mounting in vice.
- Each tool bends one size

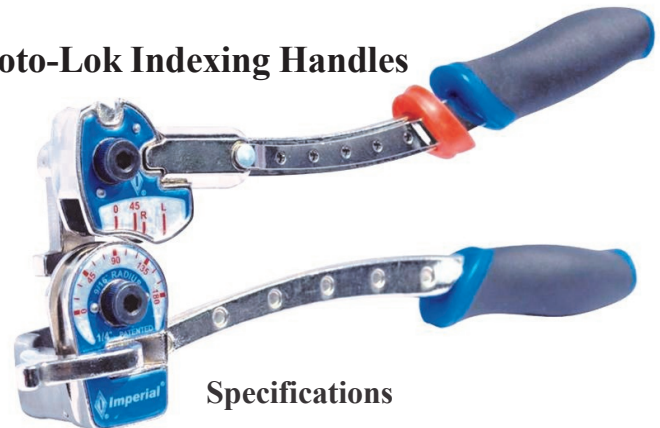

Specifications

Hydraulic Tubing

High-quality, soft annealed, seamless carbon steel hydraulic tubing ASTM A179 or equivalent. Hardness 72 HRB (130 HV) or less.

Stainless Steel

Fully annealed high-quality (Type 304, 316 etc.) (seamless or welded and drawn) stainless steel hydraulic tubing ASTM A269 or A213, or equivalent. Hardness 90 HRB (200 HV or less)

65-664-FH-04 (664FH6mm) Carbon & Stainless 0.028" to 0.065"

65-664-FH-06 (664FH8mm & 10MM) Carbon 0.035 to 0.065 -
Stainless 0.035" to 0.083"

65-664-FH-08 (664FH12mm) Carbon & Stainless 0.035" to 0.083"

Imperial Tools (Category 65)

TUBE BENDERS

For bending soft copper, aluminum, brass, steel and stainless steel

WORM GEAR TUBE BENDER

For 1/4", 5/16", 3/8", 1/2", 5/8" and 3/4" O.D. tubing.

65-600F

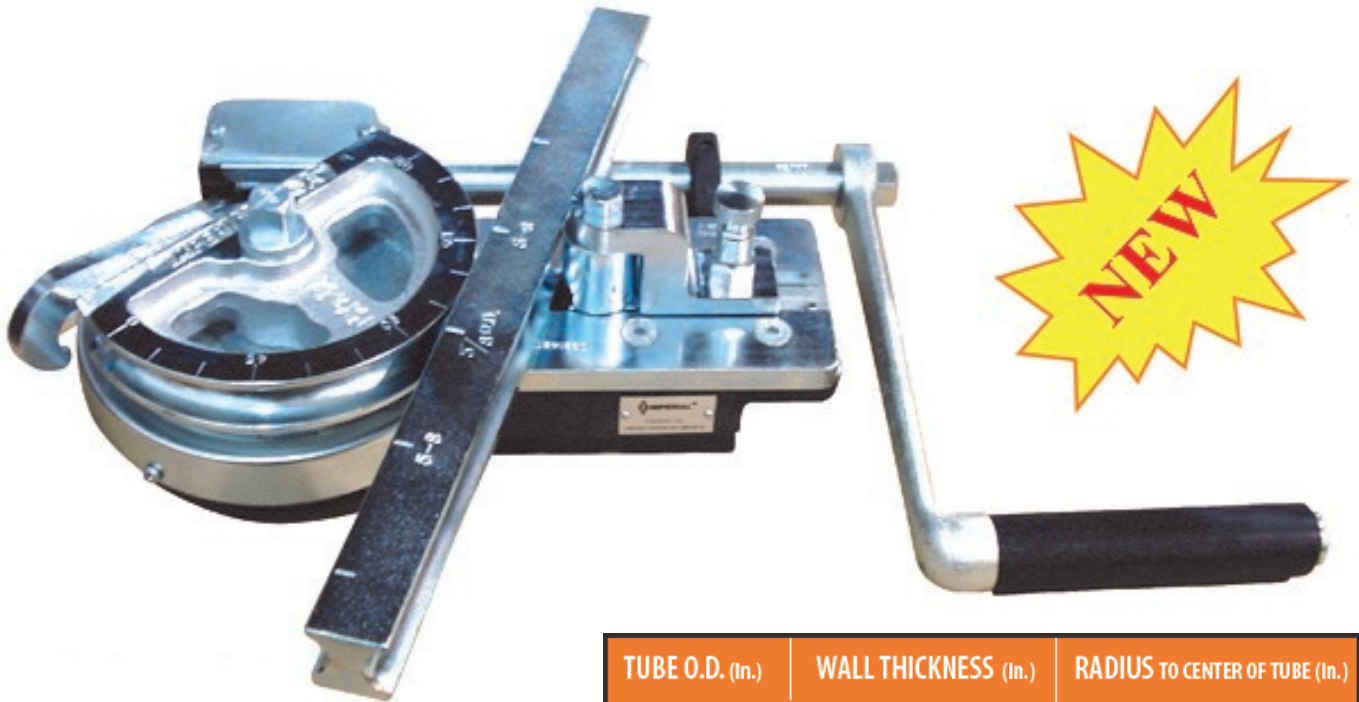

Bend aluminum, copper, brass, stainless steel and titanium with ease



* All material to be bent must be of a bending temper.

TUBE O.D. (In.)	WALL THICKNESS (In.)	RADIUS TO CENTER OF TUBE (In.)
1/4	.016 to .049	3/4
5/16	.020 to .065	1
3/8	.028 to .083	1-1/4
1/2	.035 to .083	2
5/8	.042 to .083	2-1/2
3/4	.049 to .083	3

- Precision tool for highest quality work.
- Worm gear type with 50-to-1 ratio and crank with revolving hand grip, keeps effort at a minimum and provides maximum accuracy..
- Follow bar eliminates drawing action and keeps the tube virtually perfectly round.
- Adjustable pressure roller positions quickly in index holes.
- Enclosed gears.
- Furnished in steel carrying case. Size of kit: 35 x 23 x 15cm. Weight 16Kg.

For more information on the complete range of Imperial tube benders available , including gear type benders, please contact our sales staff

Imperial Tools (Category 65)

FLARING TOOLS

For soft tubing only - copper, aluminum and brass

45° FLARING TOOLS

65-195FC 45° FLARING TOOL

For 3/16" to 5/8" O.D. Tube

- Flares 7 sizes of tubing.
- Forged steel slip-on yoke and hardened flaring bar
- Positive clamping action of bars prevents tube slippage



65-103FS 45° LARGE SIZE FLARING TOOL

For 3/4", 7/8" & 1" O.D. Tube

- Forged steel slip-on yoke and hardened flaring bar
- Positive clamping action of bars prevents tube slippage

65-500FC 45° ROL-AIR FLARING TOOL

Flares and Burnishes 3/16" to 5/8" O.D. Tube

- Faceted, hardened steel chrome finished cone rolls out and burnishes perfect 45° flares above the tube holding mechanism reducing the need for deburring
- Original wall thickness is maintained at base of flare
- Heat treated dies grip tubing without scoring



Flares rolled out above die bar by super smooth faceted cone. Maintains the integrity of the tubing.



Unique detention mechanism for rapid engagement and release of die blocks.

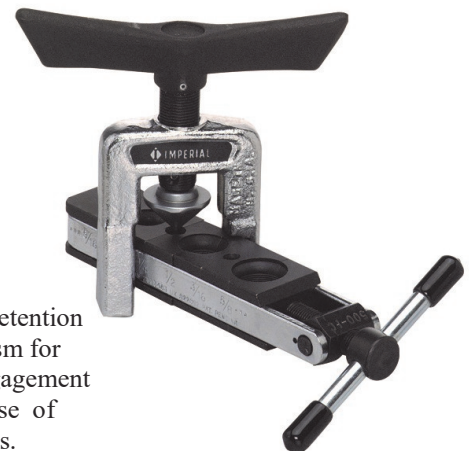

65-525F "GRABBER" 45° ROL-AIR FLARING TOOL

Adjustable opening holds all sizes

Flares and Burnishes 3/16" to 5/8" (and Metric) O.D. Tube

- Unique, self adjusting tube holding mechanism permits flaring any size tubing within the range 3/16" - 5/8" O.D. and 4.75mm to 16mm O.D. tube, Innovative, single opening design is more compact and easier to use than conventional multi opening flaring bars
- Faceted, hardened steel chrome finished cone rolls out and burnishes perfect 45° flares above the tube holding mechanism reducing the need for deburring.



Imperial Tools (Category 65)

FLARING TOOLS

For flaring soft copper, aluminum, brass, steel and stainless steel tube

45° DOUBLE FLARING TOOLS

65-93FB 45° DOUBLE FLARING TOOL

Flares 3/16" to 1/2" O.D. Tube

- Recommended for Bundy and other annealed soft tubing.
- Also makes single and double flares in soft copper or aluminum tube
- Small, lightweight and easy to handle



65-195FB DOUBLE FLARING TOOL FOR LARGER SIZES

Flares 1/4" to 3/4" O.D. Tube

- Designed for the automotive air-conditioning market
- Makes double flares in soft copper or aluminum tube



37° FLARING TOOLS

65-400F 37° ROL-AIR FLARING TOOL

For 3/16" to 5/8" O.D. Tube

- Forms 37° flares to government specifications in steel, stainless steel (including MIL- T-6845), titanium and other metal tubing.
- Positive stop gauge assures correct size of flare.
- Special burnishing action polishes the flare face
- Three rollers in flaring cone roll out 37° flare above the die block.
- Roller action cuts effort required
- Maintains original tube wall thickness - eliminates stress concentration and eliminates the need for deburring.
- Extension on yoke for clamping in vice
- Satin chrome and black finish
- Furnished in sturdy tool case.

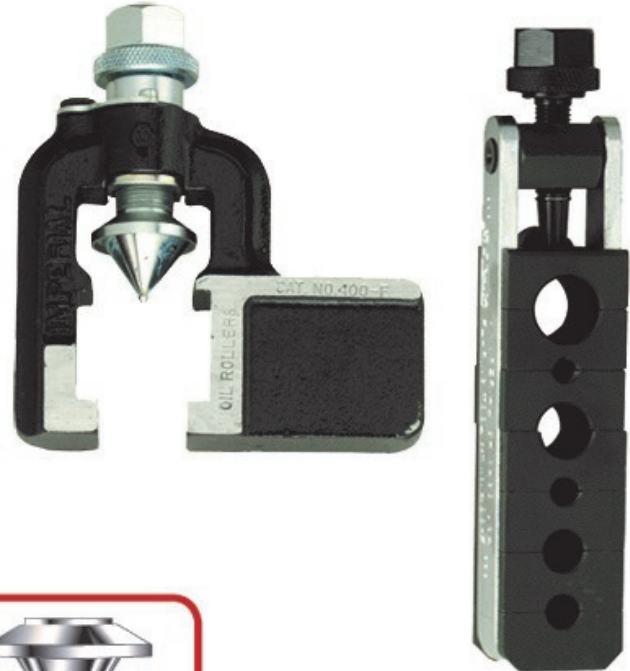

Feed, Release and Burnishing Mechanism. Flare Control Gauge



3 Rollers in Flaring Cone. Flare Formed above die block

Imperial Tools (Category 65)

FLARING TOOLS

For soft tubing only - copper, aluminum and brass

37° FLARING TOOLS

65-507FB ROL-AIR 37° FLARING TOOL

For 3/16" to 5/8" O.D. Tube

- For use with copper, aluminum and brass tubing
- Faceted, hardened steel chrome finished cone rolls out and burnishes perfect 37° flares above the tube holding mechanism reducing the need for deburring.
- New slip-on yoke permits use in tight quarters
- Larger handle with better leverage and precision threads on the feed screw make flaring effortless



65-537F LARGE SIZE ROL-AIR 37° FLARING TOOL

For 3/4" to 1-1/4" O.D. Tube

- For use with soft steel, copper, aluminum and fully annealed stainless steel tube
- Three cylinders in the flaring cone roll out and burnishes perfect 37° flares above the tube holding mechanism reducing the need for deburring.



FLARING and SWAGING TOOLS

65-275FS 45° FLARING and SWAGING TOOL

Flares 1/8" to 3/4" O.D. Tube

- Flares and swages. Converts quickly. Swivel type swaging adaptors and flaring cone are hardened steel chrome finished for easy operation
- Supplied in a tool case

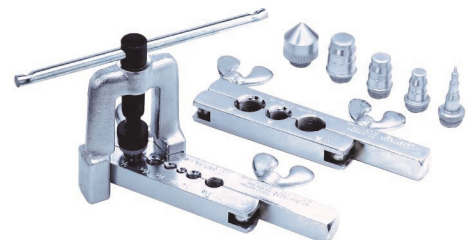

Imperial offer a comprehensive range of tube cutters, benders and flaring tools. Many of which are not listed in this catalogue. If you require a product not listed please contact our sales staff for more information

Imperial Tools (Category 65)

TUBING TOOL KITS

65-120F CUTTING and FLARING KIT

CONTAINS: TC1000 Tube cutter for 1/8" - 1-1/8" O.D. tube
375FC 45° Flaring tool for 1/8" - 3/4" O.D. tube



65-122FA CUTTING and FLARING KIT

CONTAINS: TC1000 Tube cutter for 1/8" - 1-1/8" O.D. tube
437FB 37° Flaring tool for 3/16" - 5/8" O.D. tube



65-275FSC CUTTING, FLARING and SWAGING KIT

CONTAINS: TC1000 Tube cutter for 1/8" - 1-1/8" O.D. tube
275FS Flaring and swaging tool for 1/8" - 3/4" O.D. tube



Miscellaneous Tools (Category 65)

Nylon Tube Cutter.
Cuts tube from 1/8" to 1/2"

Code : 65-NTC08



Spare Blade for Nylon Tube Cutter.
Suits 65-NTC08

Code : 65-NTC08B

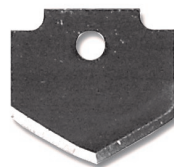

Flexible L.E.D. Flashlight

Long flexible head. Strong magnetic base for positioning light in engine bays etc. Magnetic head for picking up parts.

Code : 65-LED-FF

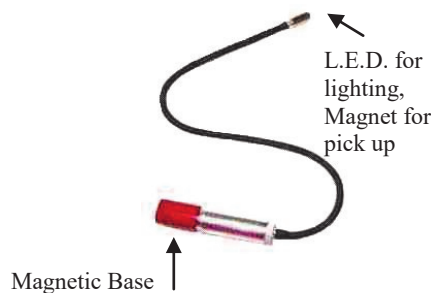

Plastic Pipe Cutter.
Cuts up to 22mm O.D.

Code : 65-PPC22

Gal Mal Fittings (Category 70)



#24GM
Reducing Bush

Code	Male	Female
70-024-0402	1/4	1/8
70-024-0602	3/8	1/8
70-024-0604	3/8	1/4
70-024-0802	1/2	1/8
70-024-0804	1/2	1/4
70-024-0806	1/2	3/8
70-024-1202	3/4	1/8
70-024-1204	3/4	1/4
70-024-1206	3/4	3/8
70-024-1208	3/4	1/2
70-024-1604	1"	1/4
70-024-1606	1"	3/8
70-024-1608	1"	1/2
70-024-1612	1"	3/4
70-024-2006	1.1/4	3/8
70-024-2008	1.1/4	1/2
70-024-2012	1.1/4	3/4
70-024-2016	1.1/4	1"
70-024-2406	1.1/2	3/8
70-024-2408	1.1/2	1/2
70-024-2412	1.1/2	3/4
70-024-2416	1.1/2	1"
70-024-2420	1.1/2	1.1/4
70-024-3206	2"	3/8
70-024-3208	2"	1/2
70-024-3212	2"	3/4
70-024-3216	2"	1"
70-024-3220	2"	1.1/4
70-024-3224	2"	1.1/2
70-024-4008	2.1/2	1/2
70-024-4012	2.1/2	3/4
70-024-4016	2.1/2	1"
70-024-4020	2.1/2	1.1/4
70-024-4024	2.1/2	1.1/2
70-024-4032	2.1/2	2"
70-024-4824	3"	1.1/2
70-024-4832	3"	2"
70-024-4840	3"	2.1/2
70-024-6432	4"	2"
70-024-6440	4"	2.1/2
70-024-6448	4"	3"
70-024-9640	6"	2.1/2
70-024-9648	6"	3"
70-024-9664	6"	4"



#25GMB
M&F Bend

Code	Size
70-025B-08	1/2
70-025B-12	3/4
70-025B-16	1"
70-025B-20	1.1/4
70-025B-24	1.1/2
70-025B-32	2"
70-025B-40	2.1/2
70-025B-48	3"
70-025B-64	4"



#25GM
M&F Elbow

Code	Size
70-025-04	1/4
70-025-06	3/8
70-025-08	1/2
70-025-12	3/4
70-025-16	1"
70-025-20	1.1/4
70-025-24	1.1/2
70-025-32	2"
70-025-40	2.1/2
70-025-48	3"
70-025-64	4"



#25GMD
45° M&F Elbow

Code	Size
70-025D-08	1/2
70-025D-12	3/4
70-025D-16	1"
70-025D-20	1.1/4
70-025D-24	1.1/2
70-025D-32	2"



#25GMDB
45° M&F Bend

Code	Size
70-025DB-08	1/2
70-025DB-12	3/4
70-025DB-16	1"
70-025DB-20	1.1/4
70-025DB-24	1.1/2
70-025DB-32	2"
70-025DB-40	2.1/2
70-025DB-48	3"
70-025DB-64	4"



#26GM
Socket (Ribbed)

Code	Size
70-026-04	1/4
70-026-06	3/8
70-026-08	1/2
70-026-12	3/4
70-026-16	1"
70-026-20	1.1/4
70-026-24	1.1/2
70-026-32	2"
70-026-40	2.1/2
70-026-48	3"
70-026-64	4"
70-026-96	6"



#27GM
Hex Nipple

Code	Size
70-027-02	1/8
70-027-04	1/4
70-027-06	3/8
70-027-08	1/2
70-027-12	3/4
70-027-16	1"
70-027-20	1.1/4
70-027-24	1.1/2
70-027-32	2"
70-027-40	2.1/2
70-027-48	3"
70-027-64	4"
70-027-96	6"



#33GM
Cap

Code	Size
70-033-04	1/4
70-033-06	3/8
70-033-08	1/2
70-033-12	3/4
70-033-16	1"
70-033-20	1.1/4
70-033-24	1.1/2
70-033-32	2"
70-033-40	2.1/2
70-033-48	3"
70-033-64	4"
70-033-96	6"

Gal Mal Fittings (Category 70)



#29GM
Reducing Socket
(Ribbed)

Code	Female	Female
70-029-0402	1/4	1/8
70-029-0602	3/8	1/8
70-029-0604	3/8	1/4
70-029-0804	1/2	1/4
70-029-0806	1/2	3/8
70-029-1204	3/4	1/4
70-029-1206	3/4	3/8
70-029-1208	3/4	1/2
70-029-1606	1"	3/8
70-029-1608	1"	1/2
70-029-1612	1"	3/4
70-029-2006	1.1/4	3/8
70-029-2008	1.1/4	1/2
70-029-2012	1.1/4	3/4
70-029-2016	1.1/4	1"
70-029-2408	1.1/2	1/2
70-029-2412	1.1/2	3/4
70-029-2416	1.1/2	1"
70-029-2420	1.1/2	1.1/4
70-029-3208	2"	1/2
70-029-3212	2"	3/4
70-029-3216	2"	1"
70-029-3220	2"	1.1/4
70-029-3224	2"	1.1/2
70-029-4012	2.1/2	3/4
70-029-4016	2.1/2	1"
70-029-4020	2.1/2	1.1/4
70-029-4024	2.1/2	1.1/2
70-029-4032	2.1/2	2"
70-029-4824	3"	1.1/2
70-029-4832	3"	2"
70-029-4840	3"	2.1/2
70-029-6432	4"	2"
70-029-6440	4"	2.1/2
70-029-6448	4"	3"
70-029-9664	6"	4"



#34GMB
Female Bend

Code	Size
70-034B-04	1/4
70-034B-06	3/8
70-034B-08	1/2
70-034B-12	3/4
70-034B-16	1"
70-034B-20	1.1/4
70-034B-24	1.1/2
70-034B-32	2"
70-034B-40	2.1/2
70-034B-48	3"
70-034B-64	4"



#34GMD
45° Female Elbow

Code	Size
70-034D-08	1/2
70-034D-12	3/4
70-034D-16	1"
70-034D-20	1.1/4
70-034D-24	1.1/2
70-034D-32	2"
70-034D-40	2.1/2
70-034D-48	3"
70-034D-64	4"



#34GMR
Reducing Female
Elbow

Code	Female	Female
70-034R-0806	1/2	3/8
70-034R-1204	3/4	1/4
70-034R-1206	3/4	3/8
70-034R-1208	3/4	1/2
70-034R-1606	1"	3/8
70-034R-1608	1"	1/2
70-034R-1612	1"	3/4
70-034R-2006	1.1/4	3/8
70-034R-2008	1.1/4	1/2
70-034R-2012	1.1/4	3/4
70-034R-2016	1.1/4	1"
70-034R-2408	1.1/2	1/2
70-034R-2412	1.1/2	3/4
70-034R-2416	1.1/2	1"
70-034R-2420	1.1/2	1.1/4
70-034R-3208	2"	1/2
70-034R-3212	2"	3/4
70-034R-3216	2"	1"
70-034R-3220	2"	1.1/4
70-034R-3224	2"	1.1/2



#35GM
Female Tee

Code	Size
70-035-04	1/4
70-035-06	3/8
70-035-08	1/2
70-035-12	3/4
70-035-16	1"
70-035-20	1.1/4
70-035-24	1.1/2
70-035-32	2"
70-035-40	2.1/2
70-035-48	3"
70-035-64	4"
70-035-96	6"



#35GMR
Reducing Female
Tee

Code	Female	Female
70-035R-0806	1/2	3/8
70-035R-1206	3/4	3/8
70-035R-1208	3/4	1/2
70-035R-1606	1"	3/8
70-035R-1608	1"	1/2
70-035R-1612	1"	3/4
70-035R-1624	1"	1.1/4
70-035R-2006	1.1/4	3/8
70-035R-2008	1.1/4	1/2
70-035R-2012	1.1/4	3/4
70-035R-2016	1.1/4	1"
70-035R-2024	1.1/4	1.1/2
70-035R-2406	1.1/2	3/8
70-035R-2408	1.1/2	1/2
70-035R-2412	1.1/2	3/4
70-035R-2416	1.1/2	1"
70-035R-2420	1.1/2	1.1/4
70-035R-2432	1.1/2	2"
70-035R-3208	2"	1/2
70-035R-3212	2"	3/4
70-035R-3216	2"	1"
70-035R-3220	2"	1.1/4
70-035R-3224	2"	1.1/2
70-035R-4016	2.1/2	1"
70-035R-4020	2.1/2	1.1/4
70-035R-4024	2.1/2	1.1/2
70-035R-4032	2.1/2	2"
70-035R-4824	3"	1.1/2
70-035R-4832	3"	2"
70-035R-4840	3"	2.1/2
70-035R-6440	4"	2.1/2
70-035R-6448	4"	3"
70-035R-9664	6"	4"



#34GM
Female Elbow

Code	Size
70-034-04	1/4
70-034-06	3/8
70-034-08	1/2
70-034-12	3/4
70-034-16	1"
70-034-20	1.1/4
70-034-24	1.1/2
70-034-32	2"
70-034-40	2.1/2
70-034-48	3"
70-034-64	4"
70-034-96	6"

Gal Mal Fittings (Category 70)



#37GM
Female Cross

Code	Size
70-037-08	1/2
70-037-12	3/4
70-037-16	1"
70-037-20	1.1/4
70-037-24	1.1/2
70-037-32	2"
70-037-40	2.1/2
70-037-48	3"
70-037-64	4"



#73GM
Reducing Nipple

Code	Male	Male
70-073-0402	1/4	1/8
70-073-0602	3/8	1/8
70-073-0604	3/8	1/4
70-073-0802	1/2	1/8
70-073-0804	1/2	1/4
70-073-0806	1/2	3/8
70-073-1204	3/4	1/4
70-073-1206	3/4	3/8
70-073-1208	3/4	1/2
70-073-1606	1"	3/8
70-073-1608	1"	1/2
70-073-1612	1"	3/4
70-073-2008	1.1/4	1/2
70-073-2012	1.1/4	3/4
70-073-2016	1.1/4	1"
70-073-2408	1.1/2	1/2
70-073-2412	1.1/2	3/4
70-073-2416	1.1/2	1"
70-073-2420	1.1/2	1.1/4
70-073-3216	2"	1"
70-073-3220	2"	1.1/4
70-073-3224	2"	1.1/2
70-073-4024	2.1/2	1.1/2
70-073-4032	2.1/2	2"
70-073-4832	3"	2"
70-073-4840	3"	2.1/2
70-073-6432	4"	2"
70-073-6440	4"	2.1/2
70-073-6448	4"	3"



#85GM
Barrell Union
Brass / Iron Seat

Code	Size
70-085-04	1/4
70-085-06	3/8
70-085-08	1/2
70-085-12	3/4
70-085-16	1"
70-085-20	1.1/4
70-085-24	1.1/2
70-085-32	2"
70-085-40	2.1/2
70-085-48	3"
70-085-64	4"



#48GMB
Male Bend

Code	Size
70-048B-08	1/2
70-048B-12	3/4
70-048B-16	1"
70-048B-20	1.1/4
70-048B-24	1.1/2
70-048B-32	2"



#85GMF
Barrell Union
Flat Seat

Code	Size
70-085F-08	1/2
70-085F-12	3/4
70-085F-16	1"
70-085F-20	1.1/4
70-085F-24	1.1/2
70-085F-32	2"
70-085F-40	2.1/2
70-085F-48	3"
70-085F-64	4"
70-085F-96	6"



#64GM
Plug
Solid up to 1"

Code	Size
70-064-02	1/8
70-064-04	1/4
70-064-06	3/8
70-064-08	1/2
70-064-12	3/4
70-064-16	1"
70-064-20	1.1/4
70-064-24	1.1/2
70-064-32	2"
70-064-40	2.1/2
70-064-48	3"
70-064-64	4"
70-064-96	6"



#74GM
Locknut

Code	Size
70-074-08	1/2
70-074-12	3/4
70-074-16	1"
70-074-20	1.1/4
70-074-24	1.1/2
70-074-32	2"
70-074-40	2.1/2
70-074-48	3"
70-074-64	4"

- Galvanised Malleable Pipe Fittings are made from Blackheart malleable cast iron. They are suitable for steam, air, water, gas and oil. Pressure ratings are shown in the table below.
- Hot dip galvanised is the standard finish. Some parts available with a black finish.
- All fittings are tested for leakage at an internal hydraulic pressure of 300 PSI or at an internal air pressure of 150 PSI.

ALSO AVAILABLE

- Gal Mal Flanges drilled Table D from 1/2 to 6"
- Galvanised U Bolts with nuts from 1/2 to 10"

Call for further details



Medium	Temperature	Max Working Pressure
Water – Non Shock Pressure	120° C	300 PSI
Steam, Air, Gas, Oil and Water	220° C	200 PSI
Steam, Air, Gas and Oil	300° C	150 PSI

Gal Steel Threaded Pipe Pieces (Category 70)

Thread Size - 1/2 to 2"

Length		1/2 BSP	3/4 BSP	1" BSP	1.1/4 BSP	1.1/2 BSP	2" BSP
	4" 100mm	70-028-0804	70-028-1204	70-028-1604	70-028-2004	70-028-2404	70-028-3204
	6" 150mm	70-028-0806	70-028-1206	70-028-1606	70-028-2006	70-028-2406	70-028-3206
	8" 200mm	70-028-0808	70-028-1208	70-028-1608	70-028-2008	70-028-2408	70-028-3208
	10" 250mm	70-028-0810	70-028-1210	70-028-1610	70-028-2010	70-028-2410	70-028-3210
	12" 300mm	70-028-0812	70-028-1212	70-028-1612	70-028-2012	70-028-2412	70-028-3212
	14" 350mm	70-028-0814	70-028-1214	70-028-1614	70-028-2014	70-028-2414	70-028-3214
	16" 400mm	70-028-0816	70-028-1216	70-028-1616	70-028-2016	70-028-2416	70-028-3216
	18" 450mm	70-028-0818	70-028-1218	70-028-1618	70-028-2018	70-028-2418	70-028-3218
	20" 500mm	70-028-0820 11.09	70-028-1220	70-028-1620	70-028-2020	70-028-2420	70-028-3220
24" 600mm	70-028-0824	70-028-1224	70-028-1624	70-028-2024	70-028-2424	70-028-3224	
30" 750mm	70-028-0830	70-028-1230	70-028-1630	70-028-2030	70-028-2430	70-028-3230	
36" 900mm	70-028-0836	70-028-1236	70-028-1636	70-028-2036	70-028-2436	70-028-3236	



Thread Size - 2.1/2 to 4"

Length		2.1/2 BSP	3" BSP	4" BSP
	6" 150mm	70-028-4006	70-028-4806	70-028-6406
	8" 200mm	70-028-4008	70-028-4808	70-028-6408
	10" 250mm	70-028-4010	70-028-4810	70-028-6410
	12" 300mm	70-028-4012	70-028-4812	70-028-6412
	14" 350mm	70-028-4014	70-028-4814	70-028-6414
	16" 400mm	70-028-4016	70-028-4816	70-028-6416
	18" 450mm	70-028-4018	70-028-4818	70-028-6418
	20" 500mm	70-028-4020	70-028-4820	70-028-6420
	24" 600mm	70-028-4024	70-028-4824	70-028-6424

Black Steel Fittings 150 Class (Category 71)



**#24BS
Reducing
Bush**

Code	Male	Female
71-024-0402	1/4 BSPT	1/8 BSP
71-024-0602	3/8 BSPT	1/8 BSP
71-024-0604	3/8 BSPT	1/4 BSP
71-024-0802	1/2 BSPT	1/8 BSP
71-024-0804	1/2 BSPT	1/4 BSP
71-024-0806	1/2 BSPT	3/8 BSP
71-024-1204	3/4 BSPT	1/4 BSP
71-024-1206	3/4 BSPT	3/8 BSP
71-024-1208	3/4 BSPT	1/2 BSP
71-024-1604	1" BSPT	1/4 BSP
71-024-1606	1" BSPT	3/8 BSP
71-024-1608	1" BSPT	1/2 BSP
71-024-1612	1" BSPT	3/4 BSP
71-024-2008	1.1/4 BSPT	1/2 BSP
71-024-2012	1.1/4 BSPT	3/4 BSP
71-024-2016	1.1/4 BSPT	1" BSP
71-024-2406	1.1/2 BSPT	3/8 BSP
71-024-2408	1.1/2 BSPT	1/2 BSP
71-024-2412	1.1/2 BSPT	3/4 BSP
71-024-2416	1.1/2 BSPT	1" BSP
71-024-2420	1.1/2 BSPT	1.1/4 BSP
71-024-3208	2" BSPT	1/2 BSP
71-024-3212	2" BSPT	3/4 BSP
71-024-3216	2" BSPT	1" BSP
71-024-3220	2" BSPT	1.1/4 BSP
71-024-3224	2" BSPT	1.1/2 BSP
71-024-4024	2.1/2 BSPT	1.1/2 BSP
71-024-4032	2.1/2 BSPT	2" BSP
71-024-4816	3" BSPT	1" BSP
71-024-4820	3" BSPT	1.1/4 BSP
71-024-4824	3" BSPT	1.1/2 BSP
71-024-4832	3" BSPT	2" BSP
71-024-4840	3" BSPT	2.1/2 BSP
71-024-6432	4" BSPT	2" BSP
71-024-6440	4" BSPT	2.1/2 BSP
71-024-6448	4" BSPT	3" BSP

150 class Black Steel Fittings are rated at 150 psi for saturated steam pressure.

Maximum working pressure for water, oil or gas at ambient temperature is 300 psi.

Please contact the sales office if you require 3000 or 6000 psi fittings.



**#25BS
M&F
Elbow**

Code	Male	Female
71-025-04	1/4 BSPT	1/4 BSP
71-025-06	3/8 BSPT	3/8 BSP
71-025-08	1/2 BSPT	1/2 BSP
71-025-12	3/4 BSPT	3/4 BSP
71-025-16	1" BSPT	1" BSP
71-025-20	1.1/4 BSPT	1.1/4 BSP
71-025-24	1.1/2 BSPT	1.1/2 BSP
71-025-32	2" BSPT	2" BSP
71-025-40	2.1/2 BSPT	2.1/2 BSP
71-025-48	3" BSPT	3" BSP
71-025-64	4" BSPT	4" BSP



**#26BS
Round
Socket**

Code	Female
71-026-02	1/8 BSP
71-026-04	1/4 BSP
71-026-06	3/8 BSP
71-026-08	1/2 BSP
71-026-12	3/4 BSP
71-026-16	1" BSP
71-026-20	1.1/4 BSP
71-026-24	1.1/2 BSP
71-026-32	2" BSP
71-026-40	2.1/2 BSP
71-026-48	3" BSP
71-026-64	4" BSP



**#26HBS
Half
Socket**

Code	Female
71-026H-06	3/8 BSP
71-026H-08	1/2 BSP
71-026H-12	3/4 BSP
71-026H-16	1" BSP
71-026H-20	1.1/4 BSP
71-026H-24	1.1/2 BSP
71-026H-32	2" BSP
71-026H-40	2.1/2 BSP
71-026H-48	3" BSP
71-026H-64	4" BSP



**#27BS
Hex
Nipple**

Code	Male
71-027-02	1/8 BSPT
71-027-04	1/4 BSPT
71-027-06	3/8 BSPT
71-027-08	1/2 BSPT
71-027-12	3/4 BSPT
71-027-16	1" BSPT
71-027-20	1.1/4 BSPT
71-027-24	1.1/2 BSPT
71-027-32	2" BSPT
71-027-40	2.1/2 BSPT
71-027-48	3" BSPT
71-027-64	4" BSPT



**#27BBS
Barrel
Nipple**

Code	Male
71-027B-02	1/8 BSPT
71-027B-04	1/4 BSPT
71-027B-06	3/8 BSPT
71-027B-08	1/2 BSPT
71-027B-12	3/4 BSPT
71-027B-16	1" BSPT
71-027B-20	1.1/4 BSPT
71-027B-24	1.1/2 BSPT
71-027B-32	2" BSPT
71-027B-40	2.1/2 BSPT
71-027B-48	3" BSPT
71-027B-64	4" BSPT



**#33BS
Cap**

Code	Female
71-033-04	1/4 BSP
71-033-06	3/8 BSP
71-033-08	1/2 BSP
71-033-12	3/4 BSP
71-033-16	1" BSP
71-033-20	1.1/4 BSP
71-033-24	1.1/2 BSP
71-033-32	2" BSP
71-033-40	2.1/2 BSP
71-033-48	3" BSP
71-033-64	4" BSP

Black Steel Fittings 150 Class (Category 71)



#29BS
Reducing
Socket

Code	Female	Female
71-029-0402	1/4 BSP	1/8 BSP
71-029-0604	3/8 BSP	1/4 BSP
71-029-0804	1/2 BSP	1/4 BSP
71-029-0806	1/2 BSP	3/8 BSP
71-029-1204	3/4 BSP	1/4 BSP
71-029-1206	3/4 BSP	3/8 BSP
71-029-1208	3/4 BSP	1/2 BSP
71-029-1606	1" BSP	3/8 BSP
71-029-1608	1" BSP	1/2 BSP
71-029-1612	1" BSP	3/4 BSP
71-029-2012	1.1/4 BSP	3/4 BSP
71-029-2016	1.1/4 BSP	1" BSP
71-029-2412	1.1/2 BSP	3/4 BSP
71-029-2416	1.1/2 BSP	1" BSP
71-029-2420	1.1/2 BSP	1.1/4 BSP
71-029-3212	2" BSP	3/4 BSP
71-029-3216	2" BSP	1" BSP
71-029-3220	2" BSP	1.1/4 BSP
71-029-3224	2" BSP	1.1/2 BSP
71-029-4024	2.1/2 BSP	1.1/2 BSP
71-029-4032	2.1/2 BSP	2" BSP
71-029-4816	3" BSP	1" BSP
71-029-4832	3" BSP	2" BSP
71-029-4840	3" BSP	2.1/2 BSP
71-029-6432	4" BSP	2" BSP
71-029-6440	4" BSP	2.1/2 BSP
71-029-6448	4" BSP	3" BSP



#34BS
Female
Elbow

Code	Female
71-034-02	1/8 BSP
71-034-04	1/4 BSP
71-034-06	3/8 BSP
71-034-08	1/2 BSP
71-034-12	3/4 BSP
71-034-16	1" BSP
71-034-20	1.1/4 BSP
71-034-24	1.1/2 BSP
71-034-32	2" BSP
71-034-40	2.1/2 BSP
71-034-48	3" BSP
71-034-64	4" BSP



#35BS
Female
Tee

Code	Female
71-035-02	1/8 BSP
71-035-04	1/4 BSP
71-035-06	3/8 BSP
71-035-08	1/2 BSP
71-035-12	3/4 BSP
71-035-16	1" BSP
71-035-20	1.1/4 BSP
71-035-24	1.1/2 BSP
71-035-32	2" BSP
71-035-40	2.1/2 BSP
71-035-48	3" BSP
71-035-64	4" BSP



#35BSR
Reducing
Female Tee

Code	Female	Female
71-035R-0604	3/8 BSP	1/4 BSP
71-035R-0804	1/2 BSP	1/4 BSP
71-035R-0806	1/2 BSP	3/8 BSP
71-035R-1206	3/4 BSP	3/8 BSP
71-035R-1208	3/4 BSP	1/2 BSP
71-035R-1608	1" BSP	1/2 BSP
71-035R-1612	1" BSP	3/4 BSP
71-035R-2012	1.1/4 BSP	3/4 BSP
71-035R-2016	1.1/4 BSP	1" BSP
71-035R-2408	1.1/2 BSP	1/2 BSP
71-035R-2412	1.1/2 BSP	3/4 BSP
71-035R-2416	1.1/2 BSP	1" BSP
71-035R-2420	1.1/2 BSP	1.1/4 BSP
71-035R-3208	2" BSP	1/2 BSP
71-035R-3212	2" BSP	3/4 BSP
71-035R-3216	2" BSP	1" BSP
71-035R-3220	2" BSP	1.1/4 BSP
71-035R-3224	2" BSP	1.1/2 BSP
71-035R-4032	2.1/2 BSP	2" BSP
71-035R-4832	3" BSP	2" BSP
71-035R-4840	3" BSP	2.1/2 BSP
71-035R-6448	4" BSP	3" BSP



#37BS
Female
Cross

Code	Female
71-037-04	1/4 BSP
71-037-06	3/8 BSP
71-037-08	1/2 BSP
71-037-12	3/4 BSP
71-037-16	1" BSP
71-037-20	1.1/4 BSP
71-037-24	1.1/2 BSP
71-037-32	2" BSP



#48BBS
Male
Bend

Code	Male
71-048-04	1/4 BSPT
71-048-06	3/8 BSPT
71-048-08	1/2 BSPT
71-048-12	3/4 BSPT
71-048-16	1" BSPT
71-048-20	1.1/4 BSPT
71-048-24	1.1/2 BSPT
71-048-32	2" BSPT
71-048-40	2.1/2 BSPT
71-048-48	3" BSPT
71-048-64	4" BSPT



#48DBBS
45° Male
Bend

Code	Male
71-048D-08	1/2 BSPT
71-048D-12	3/4 BSPT
71-048D-16	1" BSPT
71-048D-20	1.1/4 BSPT
71-048D-24	1.1/2 BSPT
71-048D-32	2" BSPT
71-048D-40	2.1/2 BSPT
71-048D-48	3" BSPT
71-048D-64	4" BSPT

Black Steel Fittings 150 Class (Category 71)



#48VBS
Bevel End
Bend

Code	Size
71-048V-08	1/2
71-048V-12	3/4
71-048V-16	1"
71-048V-20	1.1/4
71-048V-24	1.1/2
71-048V-32	2"
71-048V-40	2.1/2
71-048V-48	3"
71-048V-64	4"



#64SBS
Square Head
Plug

Code	Male
71-064S-02	1/8 BSPT
71-064S-04	1/4 BSPT
71-064S-06	3/8 BSPT
71-064S-08	1/2 BSPT
71-064S-12	3/4 BSPT
71-064S-16	1" BSPT
71-064S-20	1.1/4 BSPT
71-064S-24	1.1/2 BSPT
71-064S-32	2" BSPT



#73BS
Reducing
Nipple

Code	Male	Male
71-073-0402	1/4 BSPT	1/8 BSPT
71-073-0602	3/8 BSPT	1/8 BSPT
71-073-0604	3/8 BSPT	1/4 BSPT
71-073-0802	1/2 BSPT	1/8 BSPT
71-073-0804	1/2 BSPT	1/4 BSPT
71-073-0806	1/2 BSPT	3/8 BSPT
71-073-1204	3/4 BSPT	1/4 BSPT
71-073-1206	3/4 BSPT	3/8 BSPT
71-073-1208	3/4 BSPT	1/2 BSPT
71-073-1608	1" BSPT	1/2 BSPT
71-073-1612	1" BSPT	3/4 BSPT
71-073-2008	1.1/4 BSPT	1/2 BSPT
71-073-2012	1.1/4 BSPT	3/4 BSPT
71-073-2016	1.1/4 BSPT	1" BSPT
71-073-2412	1.1/2 BSPT	3/4 BSPT
71-073-2416	1.1/2 BSPT	1" BSPT
71-073-2420	1.1/2 BSPT	1.1/4 BSPT
71-073-3212	2" BSPT	3/4 BSPT
71-073-3216	2" BSPT	1" BSPT
71-073-3220	2" BSPT	1.1/4 BSPT
71-073-3224	2" BSPT	1.1/2 BSPT
71-073-4024	2.1/2 BSPT	1.1/2 BSPT
71-073-4032	2.1/2 BSPT	2" BSPT
71-073-4832	3" BSPT	2" BSPT
71-073-4840	3" BSPT	2.1/2 BSPT
71-073-6432	4" BSPT	2" BSPT
71-073-6448	4" BSPT	3" BSPT



#64BS
Hex
Plug

Code	Male
71-064-02	1/8 BSPT
71-064-04	1/4 BSPT
71-064-06	3/8 BSPT
71-064-08	1/2 BSPT
71-064-12	3/4 BSPT
71-064-16	1" BSPT
71-064-20	1.1/4 BSPT
71-064-24	1.1/2 BSPT
71-064-32	2" BSPT
71-064-40	2.1/2 BSPT
71-064-48	3" BSPT
71-064-64	4" BSPT



#74BS
Hex
Locknut

Code	Female
71-074-02	1/8 BSP
71-074-04	1/4 BSP
71-074-06	3/8 BSP
71-074-08	1/2 BSP
71-074-12	3/4 BSP
71-074-16	1" BSP
71-074-20	1.1/4 BSP
71-074-24	1.1/2 BSP
71-074-32	2" BSP
71-074-48	3" BSP



#85BS
Female / Female
Barrel Union

Female	Seat Material		
	Steel / Steel Code	Brass / Brass Code	Steel / Brass Code
1/4 BSP	71-085-04	71-085BB-04	71-085SB-04
3/8 BSP	71-085-06	71-085BB-06	71-085SB-06
1/2 BSP	71-085-08	71-085BB-08	71-085SB-08
3/4 BSP	71-085-12	71-085BB-12	71-085SB-12
1" BSP	71-085-16	71-085BB-16	71-085SB-16
1.1/4 BSP	71-085-20	71-085BB-20	71-085SB-20
1.1/2 BSP	71-085-24	71-085BB-24	71-085SB-24
2" BSP	71-085-32	71-085BB-32	71-085SB-32
2.1/2 BSP	71-085-40	71-085BB-40	71-085SB-40
3" BSP	71-085-48	71-085BB-48	71-085SB-48
4" BSP	71-085-64		71-085SB-64



#87BS
Male / Female
Barrel Union

Male	Female	Seat Material		
		Steel / Steel Code	Brass / Brass Code	Steel / Brass Code
1/4 BSPT	1/4 BSP	71-087-04	71-087BB-04	71-087SB-04
3/8 BSPT	3/8 BSP	71-087-06	71-087BB-06	71-087SB-06
1/2 BSPT	1/2 BSP	71-087-08	71-087BB-08	71-087SB-08
3/4 BSPT	3/4 BSP	71-087-12	71-087BB-12	71-087SB-12
1" BSPT	1" BSP	71-087-16	71-087BB-16	71-087SB-16
1.1/4 BSPT	1.1/4 BSP	71-087-20	71-087BB-20	71-087SB-20
1.1/2 BSPT	1.1/2 BSP	71-087-24	71-087BB-24	71-087SB-24
2" BSPT	2" BSP	71-087-32	71-087BB-32	71-087SB-32
2.1/2 BSPT	2.1/2 BSP	71-087-40	71-087BB-40	71-087SB-40
3" BSPT	3" BSP	71-087-48	71-087BB-48	71-087SB-48
4" BSPT	4" BSP			71-087SB-64



DBF Stainless Fittings

Part Numbering System

Lowest Alpha-Numeric Designation is always at END One

S

1

B1 J1

08 12

END ONE END TWO

MATERIAL

SHAPE

END TYPE

SIZE

S=Stainless

1=Straight
 2=Compact 90
 3=Compact 45
 4=Swept 90
 5=Swept 45
 6=Plug/Cap
 7=Tee
 8=Cross
 9=Nut

 W=Single Olive
 X=Double Olive
 Y=Flange Clamp
 Z=37° Flare Tube Fitting

A1=Hose Tail Field Replaceable
 A2=Hose Tail Crimp
 A3=Hose Tail Push On
 A4=Hose Tail Low Pressure
 B1=BSPP Male
 B2=BSPP Female Swivel Nut
 B3=BSPT Male
 B4=BSPT Female Tapped Hole
 B5=BSPP Bulkhead
 B6=BSPP Positional Male
 B7=BSPP Female Tapped Hole
 B8=BSPP Flat Face Swivel Nut
 B9=BSPT Male Swivel
 BW=Butt Weld
 C1=Code 61 SAE O'Ring Flange
 C2=Code 62 SAE O'Ring Flange
 C3=Convolutted
 C4=Compression
 J1=JIC Male
 J2=JIC Bulkhead
 J3=JIC Female Swivel Nut
 J4=JIS BSPP Inverted Male
 J5=JIS BSPP Inverted Female Swivel Nut
 M1=Metric Male DIN Light
 M2=Metric Female DIN Light Swivel Nut
 M3=Metric Male DIN Heavy
 M4=Metric Female DIN Heavy O'Ring
 M5=Metric Female DIN Heavy Swivel Nut
 M6=Metric Male Komatsu
 M7=Metric Female Komatsu
 N1=NPT Male
 N2=NPT Female Tapped Hole
 N3=NPSM Female Swivel Nut
 O1=ORFS Male
 O2=ORFS Female
 S1=SAE Male
 S2=SAE Female Swivel Nut
 S3=Socket Weld
 S4=Stand Pipe Imperial
 S5=Stand Pipe Metric
 S6=Staple lock Male
 T1=Tube Weld Female Imperial
 T2=Tube Weld Female Metric
 U1=UN O'Ring Male
 U2=UN O'Ring Male Positional

01=1/16
 02=1/8
 03=3/16
 04=1/4
 05=5/16
 06=3/8
 07=7/16
 08=1/2
 09=9/16
 10=5/8
 12=3/4
 14=7/8
 16=1''
 17=1.1/16
 19=1.3/16
 20=1.1/4
 21=1.5/16
 24=1.1/2
 26=1.5/8
 30=1.7/8
 32=2''
 40=2.1/2
 48=3''
 64=4''
 80=5''

All JIC Sizes in this catalogue are the actual thread size. If you use the tube size or JIC Dash Size when referring to JIC threads, please use the following table as a reference to the thread size.

Tube Size	JIC Dash Size	Thread
3/16	-3	3/8" x 24 TPI
1/4	-4	7/16" x 20 TPI
5/16	-5	1/2" x 20 TPI
3/8	-6	9/16" x 18 TPI
1/2	-8	3/4" x 16 TPI
5/8	-10	7/8" x 14 TPI
3/4	-12	1-1/16" x 12 TPI
7/8	-14	1-3/16" x 12 TPI
1"	-16	1-5/16" x 12 TPI
1.1/4	-20	1-5/8" x 12 TPI
1.1/2	-24	1-7/8" x 12 TPI
2"	-32	2-1/2" x 12 TPI
2.1/2	-40	3" x 12 TPI



DBF Stainless Fittings

Swage Hosetails

Straight Joiner



Code	Tail
S1A2A20404	1/4
S1A2A20606	3/8
S1A2A20808	1/2
S1A2A21010	5/8
S1A2A21212	3/4
S1A2A21616	1"
S1A2A22020	1.1/4
S1A2A22424	1.1/2
S1A2A23232	2"

BSPF Male Straight



Code	Tail	BSPF
S1A2B10402	1/4	1/8
S1A2B10404	1/4	1/4
S1A2B10606	3/8	3/8
S1A2B10808	1/2	1/2
S1A2B11212	3/4	3/4
S1A2B11616	1"	1"
S1A2B12020	1.1/4	1.1/4
S1A2B12424	1.1/2	1.1/2
S1A2B13232	2"	2"

BSP Female 90° Compact

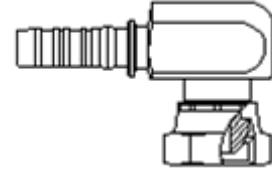

Code	Tail	BSPF
S2A2B20404	1/4	1/4
S2A2B20606	3/8	3/8
S2A2B20608	3/8	1/2
S2A2B20806	1/2	3/8
S2A2B20808	1/2	1/2
S2A2B21212	3/4	3/4
S2A2B21616	1"	1"
S2A2B22020	1.1/4	1.1/4
S2A2B22424	1.1/2	1.1/2

BSPT Male Straight

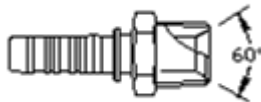

Code	Tail	BSPT
S1A2B30402	1/4	1/8
S1A2B30404	1/4	1/4
S1A2B30406	1/4	3/8
S1A2B30602	3/8	1/8
S1A2B30604	3/8	1/4
S1A2B30606	3/8	3/8
S1A2B30608	3/8	1/2
S1A2B30804	1/2	1/4
S1A2B30806	1/2	3/8
S1A2B30808	1/2	1/2
S1A2B30812	1/2	3/4
S1A2B30816	1/2	1"
S1A2B31008	5/8	1/2
S1A2B31208	3/4	1/2
S1A2B31212	3/4	3/4
S1A2B31216	3/4	1"
S1A2B31608	1"	1/2
S1A2B31612	1"	3/4
S1A2B31616	1"	1"
S1A2B32016	1.1/4	1"
S1A2B32020	1.1/4	1.1/4
S1A2B32424	1.1/2	1.1/2
S1A2B33232	2"	2"
S1A2B34040	2.1/2	2.1/2
S1A2B34848	3"	3"

BSP Female Straight

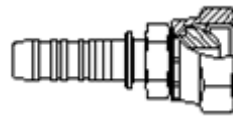

Code	Tail	BSPF
S1A2B20402	1/4	1/8
S1A2B20404	1/4	1/4
S1A2B20406	1/4	3/8
S1A2B20604	3/8	1/4
S1A2B20606	3/8	3/8
S1A2B20608	3/8	1/2
S1A2B20804	1/2	1/4
S1A2B20806	1/2	3/8
S1A2B20808	1/2	1/2
S1A2B20812	1/2	3/4
S1A2B21008	5/8	1/2
S1A2B21012	5/8	3/4
S1A2B21208	3/4	1/2
S1A2B21212	3/4	3/4
S1A2B21216	3/4	1"
S1A2B21612	1"	3/4
S1A2B21616	1"	1"
S1A2B21620	1"	1.1/4
S1A2B22020	1.1/4	1.1/4
S1A2B22024	1.1/4	1.1/2
S1A2B22424	1.1/2	1.1/2
S1A2B23232	2"	2"
S1A2B24040	2.1/2	2.1/2
S1A2B24848	3"	3"

BSP Female 45° Compact

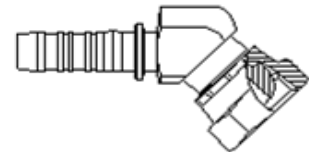

Code	Tail	BSPF
S3A2B20404	1/4	1/4
S3A2B20606	3/8	3/8
S3A2B21212	3/4	3/4

BSP Female 90° Swept

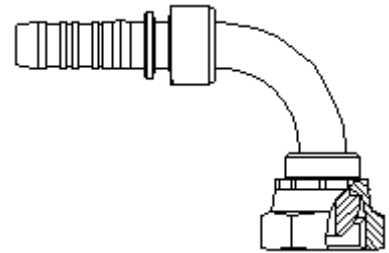

Code	Tail	BSPF
S4A2B20404	1/4	1/4
S4A2B20406	1/4	3/8
S4A2B20606	3/8	3/8
S4A2B20608	3/8	1/2
S4A2B20808	1/2	1/2
S4A2B21212	3/4	3/4
S4A2B21616	1"	1"
S4A2B22020	1.1/4	1.1/4
S4A2B22424	1.1/2	1.1/2
S4A2B23232	2"	2"



DBF Stainless Fittings

Swage Hosetails

BSP Female 45° Swept

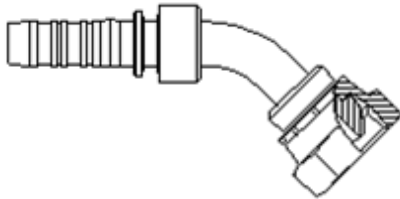

Code	Tail	BSPP
S5A2B20404	1/4	1/4
S5A2B20606	3/8	3/8
S5A2B20808	1/2	1/2
S5A2B21212	3/4	3/4
S5A2B21616	1"	1"
S5A2B22020	1.1/4	1.1/4
S5A2B22424	1.1/2	1.1/2
S5A2B23232	2"	2"

BSP Female Flatface

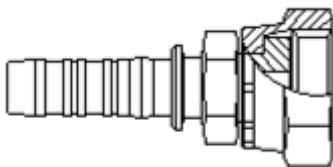

Code	Tail	BSPP
S1A2B80404	1/4	1/4
S1A2B80606	3/8	3/8
S1A2B80608	3/8	1/2
S1A2B80808	1/2	1/2
S1A2B80812	1/2	3/4
S1A2B81212	3/4	3/4
S1A2B81616	1"	1"

NPSM Female Straight



Code	Tail	NPSM
S1A2N30404	1/4	1/4
S1A2N30604	3/8	1/4
S1A2N30606	3/8	3/8
S1A2N30608	3/8	1/2
S1A2N30808	1/2	1/2
S1A2N31212	3/4	3/4
S1A2N31616	1"	1"
S1A2N32020	1.1/4	1.1/4
S1A2N32424	1.1/2	1.1/2
S1A2N33232	2"	2"

NPT Male Straight

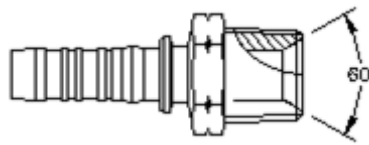

Code	Tail	NPT
S1A2N10402	1/4	1/8
S1A2N10404	1/4	1/4
S1A2N10406	1/4	3/8
S1A2N10604	3/8	1/4
S1A2N10606	3/8	3/8
S1A2N10608	3/8	1/2
S1A2N10806	1/2	3/8
S1A2N10808	1/2	1/2
S1A2N10812	1/2	3/4
S1A2N11208	3/4	1/2
S1A2N11212	3/4	3/4
S1A2N11216	3/4	1"
S1A2N11612	1"	3/4
S1A2N11616	1"	1"
S1A2N12020	1.1/4	1.1/4
S1A2N12424	1.1/2	1.1/2
S1A2N13232	2"	2"

C61 OR Flange Straight

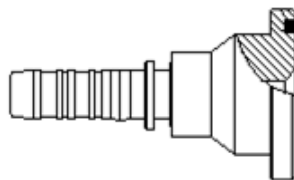

Code	Tail	Flnge
S1A2C10808	1/2	1/2
S1A2C10812	1/2	3/4
S1A2C11212	3/4	3/4
S1A2C11216	3/4	1"
S1A2C11616	1"	1"
S1A2C11620	1"	1.1/4
S1A2C12020	1.1/4	1.1/4
S1A2C12024	1.1/4	1.1/2
S1A2C12420	1.1/2	1.1/4
S1A2C12424	1.1/2	1.1/2
S1A2C12432	1.1/2	2"
S1A2C13232	2"	2"
S1A2C13240	2"	2.1/2
S1A2C14040	2.1/2	2.1/2

C61 OR Flange 90° Swept

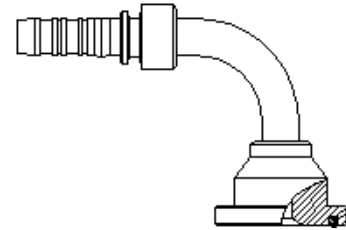

Code	Tail	Flnge
S4A2C11212	3/4	3/4
S4A2C11216	3/4	1"
S4A2C11616	1"	1"
S4A2C11620	1"	1.1/4
S4A2C12020	1.1/4	1.1/4
S4A2C12424	1.1/2	1.1/2
S4A2C12432	1.1/2	2"
S4A2C13232	2"	2"
S4A2C13240	2"	2.1/2
S4A2C14040	2.1/2	2.1/2

C62 OR Flange Straight

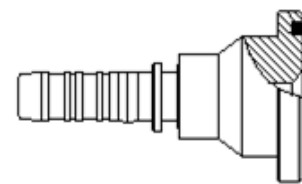

Code	Tail	Flnge
S1A2C21216	3/4	1"
S1A2C21616	1"	1"
S1A2C21620	1"	1.1/4
S1A2C22020	1.1/4	1.1/4
S1A2C22424	1.1/2	1.1/2
S1A2C23232	2"	2"

C62 OR Flange 90° Swept

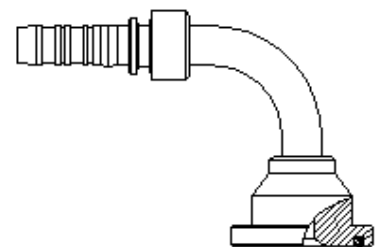

Code	Tail	Flnge
S4A2C21212	3/4	3/4
S4A2C21216	3/4	1"
S4A2C21612	1"	3/4
S4A2C21616	1"	1"
S4A2C21620	1"	1.1/4
S4A2C22020	1.1/4	1.1/4
S4A2C22424	2"	2"



DBF Stainless Fittings

Swage Hosetails

JIC Male Straight

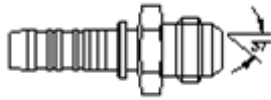

Code	Tail	JIC
S1A2J10407	1/4	7/16
S1A2J10408	1/4	1/2
S1A2J10409	1/4	9/16
S1A2J10607	3/8	7/16
S1A2J10608	3/8	1/2
S1A2J10609	3/8	9/16
S1A2J10612	3/8	3/4
S1A2J10812	1/2	3/4
S1A2J10814	1/2	7/8
S1A2J10817	1/2	1.1/16
S1A2J11217	3/4	1.1/16
S1A2J11221	3/4	1.5/16
S1A2J11621	1"	1.5/16
S1A2J12026	1.1/4	1.5/8
S1A2J12430	1.1/2	1.7/8
S1A2J13240	2"	2.1/2

JIC Female Straight

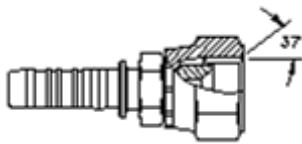

Code	Tail	JIC
S1A2J30407	1/4	7/16
S1A2J30408	1/4	1/2
S1A2J30409	1/4	9/16
S1A2J30607	3/8	7/16
S1A2J30608	3/8	1/2
S1A2J30609	3/8	9/16
S1A2J30610	3/8	5/8
S1A2J30612	3/8	3/4
S1A2J30614	3/8	7/8
S1A2J30809	1/2	9/16
S1A2J30812	1/2	3/4
S1A2J30814	1/2	7/8
S1A2J30817	1/2	1.1/16
S1A2J31014	5/8	7/8
S1A2J31017	5/8	1.1/16
S1A2J31214	3/4	7/8
S1A2J31217	3/4	1.1/16
S1A2J31221	3/4	1.5/16
S1A2J31621	1"	1.5/16
S1A2J31626	1"	1.5/8
S1A2J32026	1.1/4	1.5/8
S1A2J32430	1.1/2	1.7/8
S1A2J33240	2"	2.1/2
S1A2J34048	2.1/2	3"

JIC Female 90° Compact

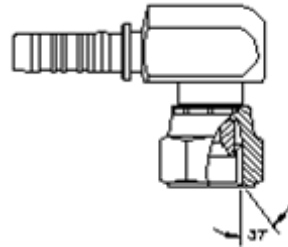

Code	Tail	JIC
S2A2J30407	1/4	7/16
S2A2J30408	1/4	1/2
S2A2J30409	1/4	9/16
S2A2J30609	3/8	9/16
S2A2J30612	3/8	3/4
S2A2J30812	1/2	3/4
S2A2J30814	1/2	7/8
S2A2J30817	1/2	1.1/16
S2A2J31217	3/4	1.1/16
S2A2J31621	1"	1.5/16
S2A2J32026	1.1/4	1.5/8

JIC Female 90° Swept

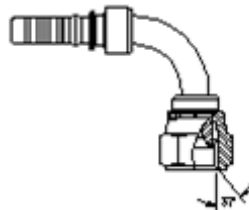

Code	Tail	JIC
S4A2J30407	1/4	7/16
S4A2J30408	1/4	1/2
S4A2J30409	1/4	9/16
S4A2J30607	3/8	7/16
S4A2J30608	3/8	1/2
S4A2J30609	3/8	9/16
S4A2J30612	3/8	3/4
S4A2J30812	1/2	3/4
S4A2J30814	1/2	7/8
S4A2J30817	1/2	1.1/16
S4A2J31014	5/8	7/8
S4A2J31214	3/4	7/8
S4A2J31217	3/4	1.1/16
S4A2J31221	3/4	1.5/16
S4A2J31621	1"	1.5/16
S4A2J32026	1.1/4	1.5/8
S4A2J32430	1.1/2	1.7/8
S4A2J33240	2"	2.1/2

JIC Female 45° Compact

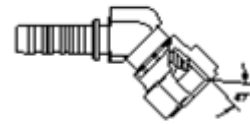

Code	Tail	JIC
S3A2J30407	1/4	7/16
S3A2J30409	1/4	9/16
S3A2J30814	1/2	7/8

JIC Female 45° Swept

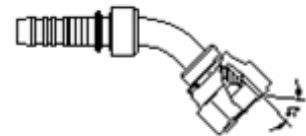

Code	Tail	JIC
S5A2J30407	1/4	7/16
S5A2J30408	1/4	1/2
S5A2J30409	1/4	9/16
S5A2J30607	3/8	7/16
S5A2J30608	3/8	1/2
S5A2J30609	3/8	9/16
S5A2J30612	3/8	3/4
S5A2J30812	1/2	3/4
S5A2J30814	1/2	7/8
S5A2J31217	3/4	1.1/16
S5A2J31221	3/4	1.5/16
S5A2J31621	1"	1.5/16
S5A2J32026	1.1/4	1.5/8
S5A2J33240	2"	2.1/2

UNO Straight

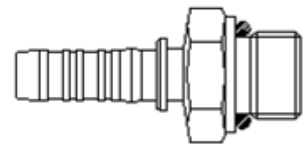

Code	Tail	UNO
S1A2U10407	1/4	9/16
S1A2U10409	1/4	11/16
S1A2U10609	3/8	9/16
S1A2U10612	3/8	3/4
S1A2U10808	1/2	1/2
S1A2U10812	1/2	3/4
S1A2U10814	1/2	7/8
S1A2U11214	3/4	7/8
S1A2U11217	3/4	1.1/16
S1A2U11621	1"	1.5/16



DBF Stainless Fittings

Swage Hosetails

Metric DIN Light Straight

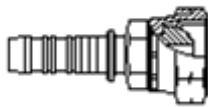

Code	Tail	Thread
S1A2M20412	1/4	12x1.5
S1A2M20414	1/4	14x1.5
S1A2M20416	1/4	16x1.5
S1A2M20616	3/8	16x1.5
S1A2M20618	3/8	18x1.5
S1A2M20622	3/8	22x1.5
S1A2M20816	1/2	16x1.5
S1A2M20818	1/2	18x1.5
S1A2M20822	1/2	22x1.5
S1A2M21026	5/8	26x1.5
S1A2M21226	3/4	26x1.5
S1A2M21230	3/4	30x2
S1A2M21236	3/4	36x2
S1A2M21636	1"	36x2
S1A2M22045	1.1/4	45x2
S1A2M22452	1.1/2	52x2

Metric DIN Heavy Straight

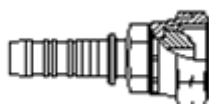

Code	Tail	Thread
S1A2M50414	1/4	14x1.5
S1A2M50416	1/4	16x1.5
S1A2M50418	1/4	18x1.5
S1A2M50616	3/8	16x1.5
S1A2M50618	3/8	18x1.5
S1A2M50620	3/8	20x1.5
S1A2M50622	3/8	22x1.5
S1A2M50624	3/8	24x1.5
S1A2M50820	1/2	20x1.5
S1A2M50824	1/2	24x1.5
S1A2M51230	3/4	30x2
S1A2M51236	3/4	36x2
S1A2M51642	1"	42x2
S1A2M52052	1.1/4	52x2

Metric DIN Light 90° Swept

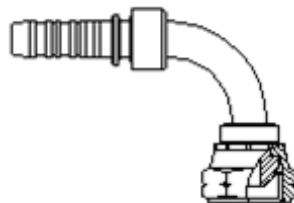

Code	Tail	Thread
S4A2M20616	3/8	16x1.5
S4A2M20618	3/8	18x1.5
S4A2M20818	1/2	18x1.5
S4A2M20822	1/2	22x1.5
S4A2M21230	3/4	30x2
S4A2M21636	1"	36x2

Metric DIN Heavy 90° Swept

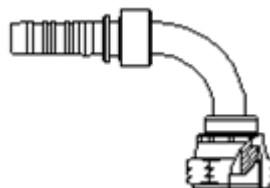

Code	Tail	Thread
S4A2M50620	3/8	20x1.5
S4A2M50824	1/2	24x1.5
S4A2M51642	1"	42x2

Stand Pipe Imperial Straight

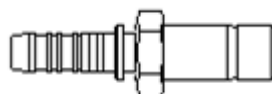

Code	Tail	Tube
S1A2S40404	1/4	1/4
S1A2S40406	1/4	3/8
S1A2S40604	3/8	1/4
S1A2S40606	3/8	3/8
S1A2S40608	3/8	1/2
S1A2S40808	1/2	1/2
S1A2S41010	5/8	5/8
S1A2S41212	3/4	3/4
S1A2S41616	1"	1"
S1A2S41620	1"	1.1/4
S1A2S42020	1.1/4	1.1/4
S1A2S42024	1.1/4	1.1/2
S1A2S42424	1.1/2	1.1/2
S1A2S43232	2"	2"

Stand Pipe Metric Straight

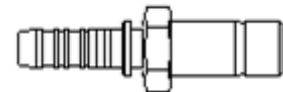

Code	Tail	Tube
S1A2S50406	1/4	6mm
S1A2S50408	1/4	8mm
S1A2S50410	1/4	10mm
S1A2S50608	3/8	8mm
S1A2S50610	3/8	10mm
S1A2S50612	3/8	12mm
S1A2S50812	1/2	12mm
S1A2S50815	1/2	15mm
S1A2S50816	1/2	16mm
S1A2S50818	1/2	18mm
S1A2S51018	5/8	18mm
S1A2S51020	5/8	20mm
S1A2S51220	3/4	20mm
S1A2S51222	3/4	22mm
S1A2S51225	3/4	25mm
S1A2S51625	1"	25mm
S1A2S51628	1"	28mm
S1A2S51630	1"	30mm

ORFS Straight



Code	Tail	ORFS
S1A2O20409	1/4	9/16
S1A2O20411	1/4	11/16
S1A2O20609	3/8	9/16
S1A2O20611	3/8	11/16
S1A2O20613	3/8	13/16
S1A2O20811	1/2	11/16
S1A2O20813	1/2	13/16
S1A2O20816	1/2	1"
S1A2O21219	3/4	1.3/16

ORFS 90° Swept

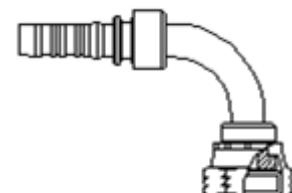

Code	Tail	ORFS
S4A2O20811	1/4	9/16
S4A2O20813	1/4	11/16



DBF Stainless Fittings

Swage Ferrules

Caution. Diameters Detailed in this Chart are a Guide only.
Test all Hose Assemblies. Use only 8 Jaw Swaging Machine

Size	Hose	R1T	R2T	R1A	R2A	R7/R8	R12	R14
1/4	Code Swage Dia Skive Lgth	SFN-04 17.2	SFN-04 18.1			SF8-04 16.5		SFT-04 12.9
5/16	Code Swage Dia Skive Lgth							SFT-05
3/8	Code Swage Dia Skive Lgth	SFN-06 21.8	SFN-06 22.4			SF8-06 19.5	SF4-06 23.3 28.0	SFT-06 16.2
1/2	Code Swage Dia Skive Lgth	SFN-08 25.6	SFN-08 26.1			SF8-08 23.4	SF4-08 26.5 27.0	SFT-08 20.6
5/8	Code Swage Dia Skive Lgth	SFN-10 28.5	SFN-10 28.9					SFT-10 23.8
3/4	Code Swage Dia Skive Lgth	SFN-12 32.7	SFN-12 33.4			SF8-12 29.3	SF4-12 32.9 39.0	SFT-12 27.0
1"	Code Swage Dia Skive Lgth	SFN-16 41.9	SFN-16 42.5			SF8-16 38.0	SF4-16 40.4 37.0	SFT-16 33.3
1.1/4	Code Swage Dia Skive Lgth	SFN-20 50.3	SFN-20 52.6	SFS-20 47.5 45.0	SFS-20 51.1 45.0		SF4-20 51.1 52.0	
1.1/2	Code Swage Dia Skive Lgth	SFN-24 57.0	SFN-24 59.4	SFS-24 54.0 50.0	SFS-24 57.4 50.0		SF4-24 57.4 52.0	
2"	Code Swage Dia Skive Lgth	SFN-32 73.2	SFN-32 74.3	SFS-32 68.0 60.0	SFS-32 70.3 60.0		SF4-32 72.4 61.0	

This chart is based on using GATES™ Hose. Be aware other hose suppliers may not have the same dimensional tolerances, but may be within SAE specifications.

HOSE AND FERRULE TYPES		
Type	Description	Ferrule
R1T	1 Wire Non Skive	SFN
R2T	2 Wire Non Skive	SFN
R1A	1 Wire Skive	SFS
R2A	2 Wire Skive	SFS
R7/R8	Thermoplastic	SF8
R12	4 Wire Multi Spiral	SF4
R14	PTFE Tube. Stainless Braid	SFT

Field Replaceable Tails and Ferrules also available.

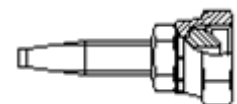

Call for details.



DBF Stainless Fittings

Push-On Hosetails

BSPT Male Straight



Code	Tail	BSPT
S1A3B30402	1/4	1/8
S1A3B30404	1/4	1/4
S1A3B30406	1/4	3/8
S1A3B30604	3/8	1/4
S1A3B30606	3/8	3/8
S1A3B30608	3/8	1/2
S1A3B30804	1/2	1/4
S1A3B30806	1/2	3/8
S1A3B30808	1/2	1/2
S1A3B30812	1/2	3/4
S1A3B31212	3/4	3/4
S1A3B31616	1"	1"

Note : Some sizes available in NPT
Call the sales office for details.

BSP Female Straight



Code	Tail	BSPP
S1A3B20404	1/4	1/4
S1A3B20406	1/4	3/8
S1A3B20606	3/8	3/8
S1A3B20608	3/8	1/2
S1A3B20808	1/2	1/2
S1A3B21212	3/4	3/4
S1A3B21616	1"	1"

Note : Some sizes available in NPT
Call the sales office for details.

BSP Female 90° Swept

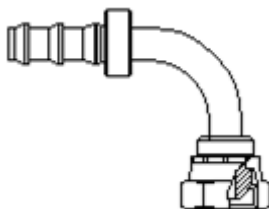

Code	Tail	BSPP
S4A3B20404	1/4	1/4
S4A3B20606	3/8	3/8
S4A3B20808	1/2	1/2
S4A3B21212	3/4	3/4

BSP Female 45° Swept

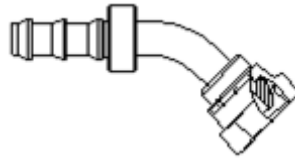

Code	Tail	BSPP
S5A3B20404	1/4	1/4
S5A3B20606	3/8	3/8
S5A3B20808	1/2	1/2
S5A3B21212	3/4	3/4

JIC Male Straight



Code	Tail	JIC
S1A3J10407	1/4	7/16
S1A3J10408	1/4	1/2
S1A3J10409	1/4	9/16
S1A3J10609	3/8	9/16
S1A3J10612	3/8	3/4
S1A3J10812	1/2	3/4
S1A3J10814	1/2	7/8
S1A3J11217	3/4	1.1/16

JIC Female Straight

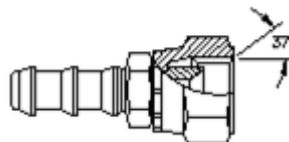

Code	Tail	JIC
S1A3J30407	1/4	7/16
S1A3J30408	1/4	1/2
S1A3J30409	1/4	9/16
S1A3J30609	3/8	9/16
S1A3J30612	3/8	3/4
S1A3J30812	1/2	3/4
S1A3J30814	1/2	7/8
S1A3J31217	3/4	1.1/16
S1A3J31621	1"	1.5/16

JIC Female 90° Swept

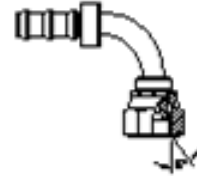

Code	Tail	JIC
S4A3J30407	1/4	7/16
S4A3J30408	1/4	1/2
S4A3J30409	1/4	9/16
S4A3J30609	3/8	9/16
S4A3J30612	3/8	3/4
S4A3J30812	1/2	3/4
S4A3J30814	1/2	7/8
S4A3J31217	3/4	1.1/16

JIC Female 45° Swept

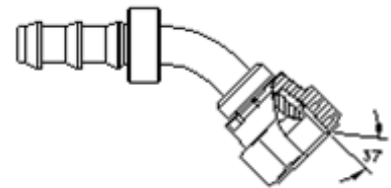

Code	Tail	JIC
S5A3J30407	1/4	7/16
S5A3J30408	1/4	1/2
S5A3J30409	1/4	9/16
S5A3J30607	3/8	7/16
S5A3J30609	3/8	9/16
S5A3J30612	3/8	3/4
S5A3J30812	1/2	3/4
S5A3J30814	1/2	7/8
S5A3J31217	3/4	1.1/16

Straight Joiner



Code	Tail
S1A3A30404	1/4
S1A3A30606	3/8
S1A3A30808	1/2
S1A3A31212	3/4



DBF Stainless Fittings

Adaptors

BSPP Male x BSPP Male

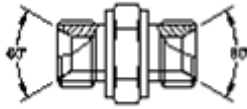

Code	BSPP	BSPP
S1B1B10202	1/8	1/8
S1B1B10204	1/8	1/4
S1B1B10404	1/4	1/4
S1B1B10406	1/4	3/8
S1B1B10408	1/4	1/2
S1B1B10606	3/8	3/8
S1B1B10608	3/8	1/2
S1B1B10612	3/8	3/4
S1B1B10808	1/2	1/2
S1B1B10812	1/2	3/4
S1B1B10816	1/2	1"
S1B1B10820	1/2	1.1/4
S1B1B11212	3/4	3/4
S1B1B11216	3/4	1"
S1B1B11220	3/4	1.1/4
S1B1B11616	1"	1"
S1B1B11620	1"	1.1/4
S1B1B11624	1"	1.1/2
S1B1B12020	1.1/4	1.1/4
S1B1B12024	1.1/4	1.1/2
S1B1B12032	1.1/4	2"
S1B1B12424	1.1/2	1.1/2
S1B1B12432	1.1/2	2"
S1B1B13232	2"	2"

BSPP Female Swivel x BSPP Male

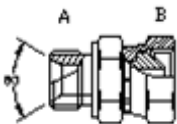

Code	BSPP	BSPT
S1B1B20404	1/4	1/4
S1B1B20406	1/4	3/8
S1B1B20606	3/8	3/8
S1B1B20808	1/2	1/2
S1B1B21212	3/4	3/4
S1B1B21616	1"	1"
S1B1B22020	1.1/4	1.1/4
S1B1B22424	1.1/2	1.1/2
S1B1B23232	2"	2"

BSPP Male x BSPT Male

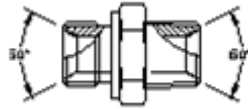

Code	BSPP	BSPT
S1B1B30202	1/8	1/8
S1B1B30402	1/8	1/8
S1B1B30404	1/4	1/4
S1B1B30406	1/4	3/8
S1B1B30408	1/4	1/2
S1B1B30604	3/8	1/4
S1B1B30606	3/8	3/8
S1B1B30608	3/8	1/2
S1B1B30612	3/8	3/4
S1B1B30804	1/2	1/4
S1B1B30806	1/2	3/8
S1B1B30808	1/2	1/2
S1B1B30812	1/2	3/4
S1B1B30816	1/2	1"
S1B1B31208	3/4	1/2
S1B1B31212	3/4	3/4
S1B1B31216	3/4	1"
S1B1B31220	3/4	1.1/4
S1B1B31608	1"	1/2
S1B1B31612	1"	3/4
S1B1B31616	1"	1"
S1B1B31620	1"	1.1/4
S1B1B31624	1"	1.1/2
S1B1B32008	1.1/4	1/2
S1B1B32016	1.1/4	1"
S1B1B32020	1.1/4	1.1/4
S1B1B32024	1.1/4	1.1/2
S1B1B32032	1.1/4	2"
S1B1B32416	1.1/2	1"
S1B1B32420	1.1/2	1.1/4
S1B1B32424	1.1/2	1.1/2
S1B1B32432	1.1/2	2"
S1B1B33224	2"	1.1/2
S1B1B33232	2"	2"
S1B1B33240	2"	2.1/2
S1B1B34040	2.1/2	2.1/2

BSPP Male Bulkhead

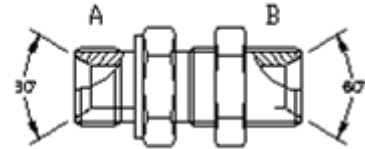

Code	BSPP	BSPP
S1B1B50404	1/4	1/4
S1B1B50606	3/8	3/8
S1B1B50808	1/2	1/2
S1B1B51212	3/4	3/4
S1B1B51616	1"	1"
S1B1B52020	1.1/4	1.1/4
S1B1B52424	1.1/2	1.1/2
S1B1B53232	2"	2"

BSPP Reducing Bush

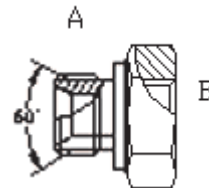

Code	BSPP	BSPP
S1B1B70604	3/8	1/4
S1B1B70804	1/2	1/4
S1B1B70806	1/2	3/8
S1B1B71204	3/4	1/4
S1B1B71604	1"	1/4
S1B1B72012	1.1/4	3/4
S1B1B72016	1.1/4	1"
S1B1B72416	1.1/2	1"
S1B1B72420	1.1/2	1.1/4
S1B1B73212	2"	3/4
S1B1B73216	2"	1"

BSPT M&F Adaptor

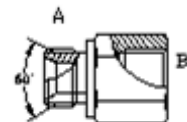

Code	BSPP	BSPP
S1B1B70404	1/4	1/4
S1B1B70612	3/8	3/4
S1B1B70812	1/2	3/4
S1B1B71212	3/4	3/4
S1B1B71216	1"	1/2



DBF Stainless Fittings

Adaptors

BSPP Male x JIC Male



Code	BSPP	JIC
S1B1J10207	1/8	7/16
S1B1J10209	1/8	9/16
S1B1J10407	1/4	7/16
S1B1J10408	1/4	1/2
S1B1J10409	1/4	9/16
S1B1J10412	1/4	3/4
S1B1J10607	3/8	7/16
S1B1J10608	3/8	1/2
S1B1J10609	3/8	9/16
S1B1J10612	3/8	3/4
S1B1J10614	3/8	7/8
S1B1J10617	3/8	1.1/16
S1B1J10807	1/2	7/16
S1B1J10808	1/2	1/2
S1B1J10809	1/2	9/16
S1B1J10812	1/2	3/4
S1B1J10814	1/2	7/8
S1B1J10817	1/2	1.1/16
S1B1J11209	3/4	9/16
S1B1J11212	3/4	3/4
S1B1J11214	3/4	7/8
S1B1J11217	3/4	1.1/16
S1B1J11221	3/4	1.5/16
S1B1J11612	1"	3/4
S1B1J11617	1"	1.1/16
S1B1J11621	1"	1.5/16
S1B1J11626	1"	1.5/8
S1B1J12017	1.1/4	1.1/16
S1B1J12021	1.1/4	1.5/16
S1B1J12026	1.1/4	1.5/8
S1B1J12030	1.1/4	1.7/8
S1B1J12421	1.1/2	1.5/16
S1B1J12426	1.1/2	1.5/8
S1B1J12430	1.1/2	1.7/8
S1B1J13230	2"	1.7/8
S1B1J13240	2"	2.1/2

BSPP Male x NPT Male

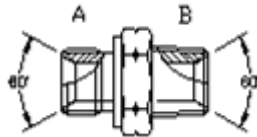

Code	BSPP	NPT
S1B1N10402	1/4	1/8
S1B1N10404	1/4	1/4
S1B1N10604	3/8	1/4
S1B1N10606	3/8	3/8
S1B1N10806	1/2	3/8
S1B1N10808	1/2	1/2
S1B1N10812	1/2	3/4
S1B1N10816	1/2	1"
S1B1N11212	3/4	3/4
S1B1N11612	1"	3/4
S1B1N11616	1"	1"
S1B1N12020	1.1/4	1.1/4
S1B1N12424	1.1/2	1.1/2
S1B1N13232	2"	2"

BSPP Male x Standpipe Imperial

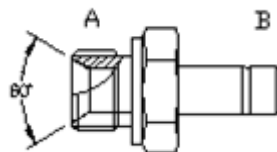

Code	BSPP	Stand
S1B1S40408	1/4	1/2
S1B1S40604	3/8	1/4
S1B1S40808	1/2	1/2
S1B1S40810	1/2	5/8
S1B1S40812	1/2	3/4
S1B1S41612	1"	3/4
S1B1S41616	1"	1"
S1B1S42020	1.1/4	1.1/4

BSPP Male x Tubeweld



Code	BSPP	T/Weld
S1B1T10404	1/4	1/4
S1B1T10606	3/8	3/8
S1B1T10808	1/2	1/2
S1B1T11212	3/4	3/4
S1B1T11616	1"	1"
S1B1T11620	1"	1.1/4
S1B1T11624	1"	1.1/2
S1B1T12020	1.1/4	1.1/4
S1B1T12424	1.1/2	1.1/2
S1B1T13232	2"	2"
S1B1T13240	2"	2.1/2
S1B1T14040	2.1/2	2.1/2

BSPP Male x UNO Male



Code	BSPP	UNO
S1B1U10407	1/4	7/16
S1B1U10408	1/4	1/2
S1B1U10409	1/4	9/16
S1B1U10608	3/8	1/2
S1B1U10609	3/8	9/16
S1B1U10612	3/8	3/4
S1B1U10614	3/8	7/8
S1B1U10617	3/8	1.1/16
S1B1U10809	1/2	9/16
S1B1U10812	1/2	3/4
S1B1U10814	1/2	7/8
S1B1U10817	1/2	1.1/16
S1B1U11212	3/4	3/4
S1B1U11214	3/4	7/8
S1B1U11614	1"	7/8
S1B1U11617	1"	1.1/16
S1B1U11621	1"	1.5/16



DBF Stainless Fittings

Adaptors

BSPP Hex Plug

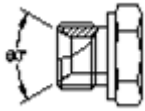

Code	BSPP
S6B102	1/8
S6B104	1/4
S6B106	3/8
S6B108	1/2
S6B112	3/4
S6B116	1"
S6B120	1.1/4
S6B124	1.1/2
S6B132	2"
S6B140	2.1/2

BSPP Internal Hex Plug

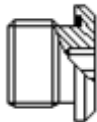

Code	BSPP
S6B102SH	1/8
S6B104SH	1/4
S6B106SH	3/8
S6B108SH	1/2
S6B112SH	3/4
S6B116SH	1"
S6B120SH	1.1/4
S6B124SH	1.1/2
S6B132SH	2"

BSPP Female Swivel x Tubeweld



Code	BSPP	T/Weld
S1B2T10404	1/4	1/4
S1B2T10606	3/8	3/8
S1B2T10608	3/8	1/2
S1B2T10808	1/2	1/2
S1B2T11212	3/4	3/4
S1B2T11616	1"	1"
S1B2T12020	1.1/4	1.1/4
S1B2T12424	1.1/2	1.1/2
S1B2T13232	2"	2"

BSPP Female Swivel x BSPT Male

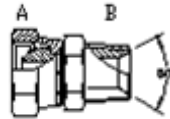

Code	BSPP	BSPT
S1B2B30202	1/8	1/8
S1B2B30404	1/4	1/4
S1B2B30406	1/4	3/8
S1B2B30408	1/4	1/2
S1B2B30606	3/8	3/8
S1B2B30806	1/2	3/8
S1B2B30808	1/2	1/2
S1B2B30812	1/2	3/4
S1B2B31208	3/4	1/2
S1B2B31212	3/4	3/4
S1B2B31616	1"	1"
S1B2B32020	1.1/4	1.1/4
S1B2B32424	1.1/2	1.1/2
S1B2B33232	2"	2"

BSPP Female Swivel x BSPT Male 90°

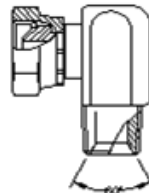

Code	BSPP	BSPT
S2B2B30404	1/4	1/4
S2B2B30406	1/4	3/8
S2B2B30606	3/8	3/8
S2B2B30808	1/2	1/2
S2B2B31212	3/4	3/4
S2B2B31616	1"	1"
S2B2B32424	1.1/2	1.1/4

BSPP Female Swivel x BSPT Male 45°

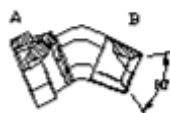

Code	BSPP	BSPT
S3B2B30404	1/4	1/4
S3B2B30808	1/2	1/2
S3B2B31212	3/4	3/4
S3B2B31616	1"	1"
S3B2B32020	1.1/4	1.1/4

BSPP Swivel Cap



Code	BSPP
S6B202	1/8
S6B204	1/4
S6B206	3/8
S6B208	1/2
S6B212	3/4
S6B216	1"
S6B220	1.1/4
S6B224	1.1/2
S6B232	2"

BSPT Male x BSPT Male

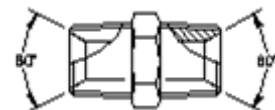

Code	BSPT	BSPT
S1B3B30202	1/8	1/8
S1B3B30204	1/8	1/4
S1B3B30206	1/8	3/8
S1B3B30404	1/4	1/4
S1B3B30406	1/4	3/8
S1B3B30408	1/4	1/2
S1B3B30412	1/4	3/4
S1B3B30606	3/8	3/8
S1B3B30608	3/8	1/2
S1B3B30612	3/8	3/4
S1B3B30616	3/8	1"
S1B3B30808	1/2	1/2
S1B3B30812	1/2	3/4
S1B3B30816	1/2	1"
S1B3B31010	5/8	5/8
S1B3B31012	5/8	3/4
S1B3B31212	3/4	3/4
S1B3B31216	3/4	1"
S1B3B31220	3/4	1.1/4
S1B3B31616	1"	1"
S1B3B31620	1"	1.1/4
S1B3B31624	1"	1.1/2
S1B3B31632	1"	2"
S1B3B32020	1.1/4	1.1/4
S1B3B32024	1.1/4	1.1/2
S1B3B32032	1.1/4	2"
S1B3B32424	1.1/2	1.1/2
S1B3B32432	1.1/2	2"
S1B3B33232	2"	2"
S1B3B34040	2.1/2	2.1/2
S1B3B34848	3"	3"
S1B3B36464	4"	4"



DBF Stainless Fittings

Adaptors

BSPT Reducing Bush

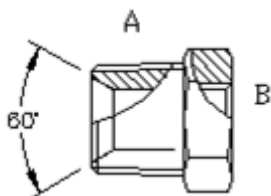

Code	BSPT	BSPT
S1B3B40402	1/4	1/8
S1B3B40602	3/8	1/8
S1B3B40604	3/8	1/4
S1B3B40802	1/2	1/8
S1B3B40804	1/2	1/4
S1B3B40806	1/2	3/8
S1B3B41204	3/4	1/4
S1B3B41206	3/4	3/8
S1B3B41208	3/4	1/2
S1B3B41604	1"	1/4
S1B3B41606	1"	3/8
S1B3B41608	1"	1/2
S1B3B41612	1"	3/4
S1B3B42012	1.1/4	3/4
S1B3B42016	1.1/4	1"
S1B3B42412	1.1/2	3/4
S1B3B42416	1.1/2	1"
S1B3B42420	1.1/2	1.1/4
S1B3B43208	2"	1/2
S1B3B43216	2"	1"
S1B3B43220	2"	1.1/4
S1B3B43224	2"	1.1/2
S1B3B44032	2.1/2	2"
S1B3B44832	3"	2"

BSPT M&F Adaptor

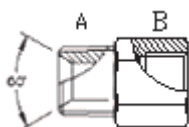

Code	BSPT	BSPT
S1B3B40404	1/4	1/4
S1B3B40606	3/8	3/8
S1B3B40808	1/2	1/2
S1B3B41212	3/4	3/4
S1B3B41616	1"	1"
S1B3B42424	1.1/2	1.1/2
S1B3B43232	2"	2"

BSPT Male x JIC Male

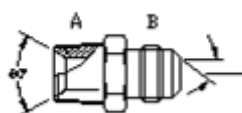

Code	BSPT	JIC
S1B3J10207	1/8	7/16
S1B3J10208	1/8	1/2
S1B3J10209	1/8	9/16
S1B3J10407	1/4	7/16
S1B3J10408	1/4	1/2
S1B3J10409	1/4	9/16
S1B3J10412	1/4	3/4
S1B3J10414	1/4	7/8
S1B3J10607	3/8	7/16
S1B3J10608	3/8	1/2
S1B3J10609	3/8	9/16
S1B3J10612	3/8	3/4
S1B3J10614	3/8	7/8
S1B3J10617	3/8	1.1/16
S1B3J10807	1/2	7/16
S1B3J10808	1/2	1/2
S1B3J10809	1/2	9/16
S1B3J10812	1/2	3/4
S1B3J10814	1/2	7/8
S1B3J10817	1/2	1.1/16
S1B3J11209	3/4	9/16
S1B3J11212	3/4	3/4
S1B3J11214	3/4	7/8
S1B3J11217	3/4	1.1/16
S1B3J11221	3/4	1.5/16
S1B3J11612	1"	3/4
S1B3J11614	1"	7/8
S1B3J11617	1"	1.1/16
S1B3J11621	1"	1.5/16
S1B3J11626	1"	1.5/8
S1B3J12021	1.1/4	1.5/16
S1B3J12026	1.1/4	1.5/8
S1B3J12030	1.1/4	1.7/8
S1B3J12426	1.1/2	1.5/8
S1B3J12430	1.1/2	1.7/8
S1B3J12440	1.1/2	2.1/2
S1B3J13230	2"	1.7/8
S1B3J13240	2"	2.1/2
S1B3J14048	2.1/2	3"

BSPT Male x JIC Female Swivel

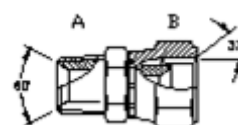

Code	BSPT	JIC
S1B3J30207	1/8	7/16
S1B3J30209	1/8	9/16
S1B3J30407	1/4	7/16
S1B3J30408	1/4	1/2
S1B3J30409	1/4	9/16
S1B3J30412	1/4	3/4
S1B3J30607	3/8	7/16
S1B3J30609	3/8	9/16
S1B3J30612	3/8	3/4
S1B3J30614	3/8	7/8
S1B3J30812	1/2	3/4
S1B3J30814	1/2	7/8
S1B3J31217	3/4	1.1/16
S1B3J31621	1"	1.5/16

BSPT Male x DIN(L) Male

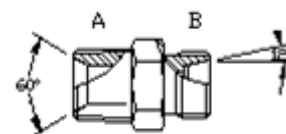

Code	BSPT	Thread
S1B3M10412	1/4	12x1.5
S1B3M10414	1/4	14x1.5
S1B3M10416	1/4	16x1.5
S1B3M10616	3/8	16x1.5
S1B3M10618	3/8	18x1.5
S1B3M10622	3/8	22x1.5
S1B3M10818	1/2	18x1.5
S1B3M10822	1/2	22x1.5
S1B3M10826	1/2	26x1.5
S1B3M11230	3/4	30x2
S1B3M11236	3/4	36x2

BSPT Male x DIN(H) Male

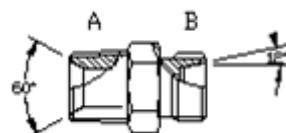

Code	BSPT	Thread
S1B3M30618	3/8	18x1.5
S1B3M30822	1/2	22x1.5
S1B3M30824	1/2	24x1.5
S1B3M31236	3/4	36x2
S1B3M32042	1.1/4	42x2



DBF Stainless Fittings

Adaptors

BSPT Male x Tubeweld

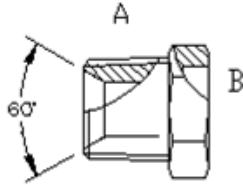

Code	BSPT	T/Weld
S1B3T10404	1/4	1/4
S1B3T10606	3/8	3/8
S1B3T10808	1/2	1/2
S1B3T11212	3/4	3/4
S1B3T11216	3/4	1"
S1B3T11612	1"	3/4
S1B3T11616	1"	1"
S1B3T12020	1.1/4	1.1/4
S1B3T12024	1.1/4	1.1/2
S1B3T12416	1.1/2	1"
S1B3T12420	1.1/2	1.1/4
S1B3T12424	1.1/2	1.1/2
S1B3T13232	2"	2"

BSPT Male 90° Elbow

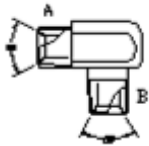

Code	BSPT	BSPT
S2B3B30202	1/8	1/8
S2B3B30204	1/8	1/4
S2B3B30404	1/4	1/4
S2B3B30406	1/4	3/8
S2B3B30408	1/4	1/2
S2B3B30606	3/8	3/8
S2B3B30608	3/8	1/2
S2B3B30612	3/8	3/4
S2B3B30808	1/2	1/2
S2B3B30812	1/2	3/4
S2B3B31212	3/4	3/4
S2B3B31216	3/4	1"
S2B3B31616	1"	1"
S2B3B32020	1.1/4	1.1/4
S2B3B32424	1.1/2	1.1/2
S2B3B33232	2"	2"

BSPT Male x UNO Male

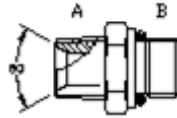

Code	BSPT	UNO
S1B3U10407	1/4	7/16
S1B3U10409	1/4	9/16
S1B3U10609	3/8	9/16
S1B3U10612	3/8	3/4
S1B3U10614	3/8	7/8
S1B3U10812	1/2	3/4
S1B3U10814	1/2	7/8
S1B3U10817	1/2	1.1/16
S1B3U11212	3/4	3/4
S1B3U11214	3/4	7/8
S1B3U11217	3/4	1.1/16
S1B3U11226	3/4	1.5/8

BSPT Male x BSPT Fem 90°

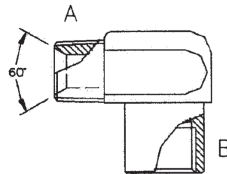

Code	BSPT	BSPT
S2B3B40404	1/4	1/4
S2B3B40604	3/8	1/4
S2B3B40606	3/8	3/8
S2B3B40808	1/2	1/2
S2B3B41212	3/4	3/4
S2B3B41616	1"	1"
S2B3B42020	1.1/4	1.1/4
S2B3B42424	1.1/2	1.1/2

BSPT Male 45° Elbow



Code	BSPT	BSPT
S3B3B30404	1/4	1/4
S3B3B30606	3/8	3/8
S3B3B30808	1/2	1/2
S3B3B31212	3/4	3/4

BSPT Male x JIC Male 90°

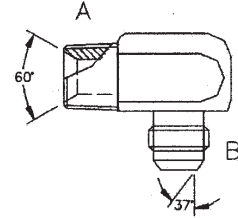

Code	BSPT	JIC
S2B3J10207	1/8	7/16
S2B3J10209	1/8	9/16
S2B3J10407	1/4	7/16
S2B3J10408	1/4	1/2
S2B3J10409	1/4	9/16
S2B3J10412	1/4	3/4
S2B3J10607	3/8	7/16
S2B3J10608	3/8	1/2
S2B3J10609	3/8	9/16
S2B3J10612	3/8	3/4
S2B3J10614	3/8	7/8
S2B3J10807	1/2	7/16
S2B3J10808	1/2	1/2
S2B3J10809	1/2	9/16
S2B3J10812	1/2	3/4
S2B3J10814	1/2	7/8
S2B3J10817	1/2	1.1/16
S2B3J11209	3/4	9/16
S2B3J11212	3/4	3/4
S2B3J11214	3/4	7/8
S2B3J11217	3/4	1.1/16
S2B3J11221	3/4	1.5/16
S2B3J11621	1"	1.5/16
S2B3J11626	1"	1.5/8
S2B3J12026	1.1/4	1.5/8

BSPT Male x JIC Male 45°

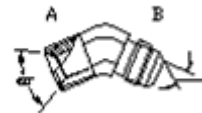

Code	BSPT	JIC
S3B3J10209	1/8	9/16
S3B3J10407	1/4	7/16
S3B3J10409	1/4	9/16
S3B3J10609	3/8	9/16
S3B3J10614	3/8	7/8
S3B3J10809	1/2	9/16
S3B3J10812	1/2	3/4
S3B3J10814	1/2	7/8
S3B3J11212	3/4	3/4
S3B3J11217	3/4	1.1/16



DBF Stainless Fittings

Adaptors

BSPT Hex Plug

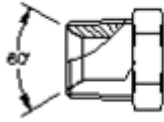

Code	BSPT
S6B302	1/8
S6B304	1/4
S6B306	3/8
S6B308	1/2
S6B312	3/4
S6B316	1"
S6B320	1.1/4
S6B324	1.1/2
S6B332	2"

BSPT Internal Hex Plug



Code	BSPT
S6B302SH	1/8
S6B304SH	1/4
S6B306SH	3/8
S6B308SH	1/2
S6B312SH	3/4
S6B316SH	1"
S6B320SH	1.1/4
S6B324SH	1.1/2
S6B332SH	2"

BSPT Male x BSPP Female Swivel Run Tee

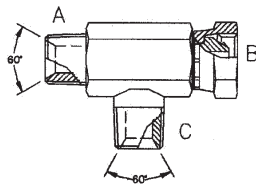

Code	BSPT	BSPP
S7B3B2B304	1/4	1/4
S7B3B2B306	3/8	3/8
S7B3B2B308	1/2	1/2
S7B3B2B312	3/4	3/4

BSPT Male Tee

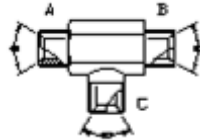

Code	BSPT
S7B3B3B304	1/4
S7B3B3B306	3/8
S7B3B3B308	1/2
S7B3B3B312	3/4
S7B3B3B316	1"
S7B3B3B320	1.1/4
S7B3B3B324	1.1/2

BSPT Female Socket

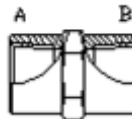

Code	BSPT	BSPT
S1B4B40202	1/8	1/8
S1B4B40404	1/4	1/4
S1B4B40406	1/4	3/8
S1B4B40606	3/8	3/8
S1B4B40608	3/8	1/2
S1B4B40808	1/2	1/2
S1B4B40812	1/2	3/4
S1B4B41212	3/4	3/4
S1B4B41616	1"	1"
S1B4B42020	1.1/4	1.1/4
S1B4B42424	1.1/2	1.1/2
S1B4B43232	2"	2"
S1B4B44040	2.1/2	2.1/2
S1B4B44848	3"	2"

BSPT Female 45° Elbow



Code	BSPT	BSPT
S3B4B40808	1/2	1/2
S3B4B42020	1.1/4	1.1/4
S3B4B42424	1.1/2	1.1/2

BSPT Female 90° Elbow

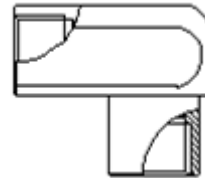

Code	BSPT	BSPT
S2B4B40404	1/4	1/4
S2B4B40606	3/8	3/8
S2B4B40808	1/2	1/2
S2B4B41212	3/4	3/4
S2B4B41616	1"	1"
S2B4B42020	1.1/4	1.1/4
S2B4B42424	1.1/2	1.1/2
S2B4B43232	2"	2"

BSPT Female Tee

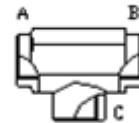

Code	BSPT
S7B4B4B404	1/4
S7B4B4B406	3/8
S7B4B4B408	1/2
S7B4B4B412	3/4
S7B4B4B416	1"
S7B4B4B420	1.1/4
S7B4B4B424	1.1/2

BSPP Positional Male x JIC Male 90°

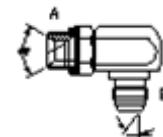

Code	BSPP	JIC
S2B6J10207	1/8	7/16
S2B6J10407	1/4	7/16
S2B6J10409	1/4	9/16
S2B6J10609	3/8	9/16
S2B6J10612	3/8	3/4
S2B6J10812	1/2	3/4
S2B6J10814	1/2	7/8
S2B6J11217	3/4	1.1/16



DBF Stainless Fittings

Adaptors

JIC Male x JIC Male



Code	JIC	JIC
SIJ1J10607	3/8	7/16
SIJ1J10707	7/16	7/16
SIJ1J10708	7/16	1/2
SIJ1J10709	7/16	9/16
SIJ1J10808	1/2	1/2
SIJ1J10809	1/2	9/16
SIJ1J10909	9/16	9/16
SIJ1J10912	9/16	3/4
SIJ1J10914	9/16	7/8
SIJ1J10917	9/16	1.1/16
SIJ1J11212	3/4	3/4
SIJ1J11214	3/4	7/8
SIJ1J11217	3/4	1.1/16
SIJ1J11414	7/8	7/8
SIJ1J11417	7/8	1.1/16
SIJ1J11717	1.1/16	1.1/16
SIJ1J11721	1.1/16	1.5/16
SIJ1J12121	1.5/16	1.5/16
SIJ1J12126	1.5/16	1.5/8
SIJ1J12626	1.5/8	1.5/8
SIJ1J12630	1.5/8	1.7/8
SIJ1J13030	1.7/8	1.7/8
SIJ1J13040	1.7/8	2.1/2
SIJ1J14040	2.1/2	2.1/2

JIC Male x JIC Male 90°

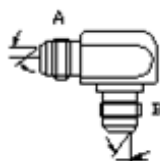

Code	JIC	JIC
S2J1J10707	7/16	7/16
S2J1J10909	9/16	9/16
S2J1J11212	3/4	3/4
S2J1J11414	7/8	7/8
S2J1J11717	1.1/16	1.1/16
S2J1J11721	1.1/16	1.5/16
S2J1J12121	1.5/16	1.5/16
S2J1J12626	1.5/8	1.5/8
S2J1J13030	1.7/8	1.7/8

JIC Male x JIC Female

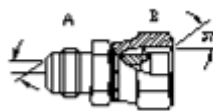

Code	JIC	JIC
SIJ1J30707	7/16	7/16
SIJ1J30709	7/16	9/16
SIJ1J30712	7/16	3/4
SIJ1J30714	7/16	7/8
SIJ1J30909	9/16	9/16
SIJ1J30912	9/16	3/4
SIJ1J30914	9/16	7/8
SIJ1J30917	9/16	1.1/16
SIJ1J31212	3/4	3/4
SIJ1J31214	3/4	7/8
SIJ1J31217	3/4	1.1/16
SIJ1J31221	3/4	1.5/16
SIJ1J31409	7/8	9/16
SIJ1J31414	7/8	7/8
SIJ1J31417	7/8	1.1/16
SIJ1J31421	7/8	1.5/16
SIJ1J31717	1.1/16	1.1/16
SIJ1J31721	1.1/16	1.5/16
SIJ1J31730	1.1/16	1.7/8
SIJ1J32121	1.5/16	1.5/16
SIJ1J32126	1.5/16	1.5/8
SIJ1J32626	1.5/8	1.5/8
SIJ1J33030	1.7/8	1.7/8

JIC Male x JIC Female 90°

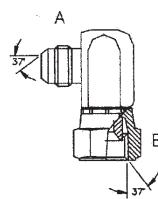

Code	JIC	JIC
S2J1J30707	7/16	7/16
S2J1J30808	1/2	1/2
S2J1J30909	9/16	9/16
S2J1J31212	3/4	3/4
S2J1J31414	7/8	7/8
S2J1J31717	1.1/16	1.1/16
S2J1J32121	1.5/16	1.5/16
S2J1J32626	1.5/8	1.5/8
S2J1J33030	1.7/8	1.7/8

JIC Male x NPT Male

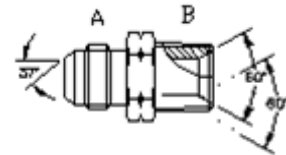

Code	JIC	NPT
SIJ1N10702	7/16	1/8
SIJ1N10704	7/16	1/4
SIJ1N10706	7/16	3/8
SIJ1N10708	7/16	1/2
SIJ1N10802	1/2	1/8
SIJ1N10804	1/2	1/4
SIJ1N10806	1/2	3/8
SIJ1N10808	1/2	1/2
SIJ1N10902	9/16	1/8
SIJ1N10904	9/16	1/4
SIJ1N10906	9/16	3/8
SIJ1N10908	9/16	1/2
SIJ1N10912	9/16	3/4
SIJ1N11204	3/4	1/4
SIJ1N11206	3/4	3/8
SIJ1N11208	3/4	1/2
SIJ1N11212	3/4	3/4
SIJ1N11216	3/4	1"
SIJ1N11404	7/8	1/4
SIJ1N11406	7/8	3/8
SIJ1N11408	7/8	1/2
SIJ1N11412	7/8	3/4
SIJ1N11416	7/8	1"
SIJ1N11708	1.1/16	1/2
SIJ1N11712	1.1/16	3/4
SIJ1N11716	1.1/16	1"
SIJ1N11720	1.1/16	1.1/4
SIJ1N11724	1.1/16	1.1/2
SIJ1N12112	1.5/16	3/4
SIJ1N12116	1.5/16	1"
SIJ1N12120	1.5/16	1.1/4
SIJ1N12620	1.5/8	1.1/4
SIJ1N12624	1.5/8	1.1/2
SIJ1N13024	1.7/8	1.1/2
SIJ1N13032	1.7/8	2"
SIJ1N14032	2.1/2	2"
SIJ1N14040	2.1/2	2.1/2



DBF Stainless Fittings

Adaptors

JIC Male x Standpipe

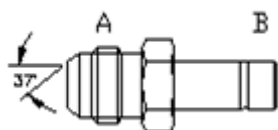

Code	JIC	Stand
SIJ1S40703	7/16	3/16
SIJ1S40704	7/16	1/4
SIJ1S40706	7/16	3/8
SIJ1S40906	9/16	3/8
SIJ1S40908	9/16	1/2
SIJ1S40910	9/16	5/8
SIJ1S41206	3/4	3/8
SIJ1S41208	3/4	1/2
SIJ1S41210	3/4	5/8
SIJ1S41410	7/8	5/8
SIJ1S41712	1.1/16	3/4
SIJ1S42116	1.5/16	1"
SIJ1S42120	1.5/16	1.1/4
SIJ1S42124	1.5/16	1.1/2
SIJ1S42620	1.5/8	1.1/4
SIJ1S42624	1.5/8	1.1/2
SIJ1S43024	1.7/8	1.1/2

JIC Male x Tubeweld

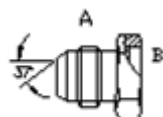

Code	JIC	T/Weld
SIJ1T10704	7/16	1/4
SIJ1T10904	9/16	1/4
SIJ1T10906	9/16	3/8
SIJ1T11206	3/4	3/8
SIJ1T11208	3/4	1/2
SIJ1T11212	3/4	3/4
SIJ1T11408	7/8	1/2
SIJ1T11410	7/8	5/8
SIJ1T11412	7/8	3/4
SIJ1T11712	1.1/16	3/4
SIJ1T11714	1.1/16	7/8
SIJ1T11716	1.1/16	1"
SIJ1T12116	1.5/16	1"
SIJ1T12620	1.5/8	1.1/4
SIJ1T12624	1.5/8	1.1/2
SIJ1T13024	1.7/8	1.1/2
SIJ1T13032	1.7/8	2"
SIJ1T14032	2.1/2	2"

JIC Male x UNO Male

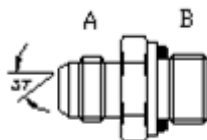

Code	JIC	UNO
SIJ1U10607	3/8	7/16
SIJ1U10705	7/16	5/16
SIJ1U10707	7/16	7/16
SIJ1U10708	7/16	1/2
SIJ1U10709	7/16	9/16
SIJ1U10712	7/16	3/4
SIJ1U10807	1/2	7/16
SIJ1U10808	1/2	1/2
SIJ1U10907	9/16	7/16
SIJ1U10908	9/16	1/2
SIJ1U10909	9/16	9/16
SIJ1U10912	9/16	3/4
SIJ1U10914	9/16	7/8
SIJ1U11209	3/4	9/16
SIJ1U11212	3/4	3/4
SIJ1U11214	3/4	7/8
SIJ1U11217	3/4	1.1/16
SIJ1U11412	7/8	3/4
SIJ1U11414	7/8	7/8
SIJ1U11417	7/8	1.1/16
SIJ1U11421	7/8	1.5/16
SIJ1U11712	1.1/16	3/4
SIJ1U11714	1.1/16	7/8
SIJ1U11717	1.1/16	1.1/16
SIJ1U11721	1.1/16	1.5/16
SIJ1U12114	1.5/16	7/8
SIJ1U12117	1.5/16	1.1/16
SIJ1U12121	1.5/16	1.5/16
SIJ1U12126	1.5/16	1.5/8
SIJ1U12621	1.5/8	1.5/16
SIJ1U12626	1.5/8	1.5/8
SIJ1U12630	1.5/8	1.7/8
SIJ1U13026	1.7/8	1.5/8
SIJ1U13030	1.7/8	1.7/8
SIJ1U14030	2.1/2	1.7/8
SIJ1U14040	2.1/2	2.1/2

JIC Male Bulkhead

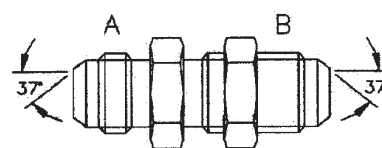

Code	JIC	JIC
SIJ1J20707	7/16	7/16
SIJ1J20808	1/2	1/2
SIJ1J20909	9/16	9/16
SIJ1J21212	3/4	3/4
SIJ1J21414	7/8	7/8
SIJ1J21717	1.1/16	1.1/16
SIJ1J22121	1.5/16	1.5/16
SIJ1J22626	1.5/8	1.5/8
SIJ1J23030	1.7/8	1.7/8
SIJ1J24040	2.1/2	2.1/2

Some sizes also available in varying lengths. Contact the office for details.

JIC Male x NPT Male 90°



Code	JIC	NPT
S2J1N10702	7/16	1/8
S2J1N10704	7/16	1/4
S2J1N10706	7/16	3/8
S2J1N10708	7/16	1/2
S2J1N10804	1/2	1/4
S2J1N10902	9/16	1/8
S2J1N10904	9/16	1/4
S2J1N10906	9/16	3/8
S2J1N10908	9/16	1/2
S2J1N11204	3/4	1/4
S2J1N11206	3/4	3/8
S2J1N11208	3/4	1/2
S2J1N11406	7/8	3/8
S2J1N11408	7/8	1/2
S2J1N11712	1.1/16	3/4
S2J1N12112	1.5/16	3/4
S2J1N12116	1.5/16	1"
S2J1N12620	1.5/8	1.1/4
S2J1N13024	1.7/8	1.1/2



DBF Stainless Fittings

Adaptors

JIC Male x UNO Positional Male 90°

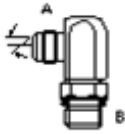

Code	JIC	UNO
S2J1U20707	7/16	7/16
S2J1U20709	7/16	9/16
S2J1U20808	1/2	1/2
S2J1U20909	9/16	9/16
S2J1U20912	9/16	3/4
S2J1U21209	3/4	9/16
S2J1U21212	3/4	3/4
S2J1U21214	3/4	7/8
S2J1U21412	7/8	3/4
S2J1U21414	7/8	7/8
S2J1U21712	1.1/16	3/4
S2J1U21714	1.1/16	7/8
S2J1U21717	1.1/16	1.1/16
S2J1U21721	1.1/16	1.5/16
S2J1U22121	1.5/16	1.5/16
S2J1U22626	1.5/8	1.5/8

JIC Female x Tubeweld



Code	JIC	T/Weld
SIJ3T10704	7/16	1/4
SIJ3T10706	7/16	3/8
SIJ3T10904	9/16	1/4
SIJ3T10906	9/16	3/8
SIJ3T10908	9/16	1/2
SIJ3T11206	3/4	3/8
SIJ3T11208	3/4	1/2
SIJ3T11212	3/4	3/4
SIJ3T11408	7/8	1/2
SIJ3T11410	7/8	5/8
SIJ3T11412	7/8	3/4
SIJ3T11712	1.1/16	3/4
SIJ3T11716	1.1/16	1"
SIJ3T12116	1.5/16	1"
SIJ3T12120	1.5/16	1.1/4
SIJ3T12620	1.5/8	1.1/4
SIJ3T12624	1.5/8	1.1/2
SIJ3T13024	1.7/8	1.1/2
SIJ3T14032	2.1/2	2"

JIC Male x NPT Female 45°

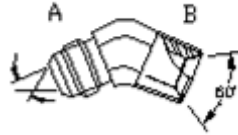

Code	JIC	NPT
S3J1N10702	7/16	1/8
S3J1N10704	7/16	1/4
S3J1N10904	9/16	1/4
S3J1N10906	9/16	3/8
S3J1N11208	3/4	1/2
S3J1N11408	7/8	1/2
S3J1N11712	1.1/16	3/4
S3J1N12620	1.5/8	1.1/4
S3J1N13024	1.7/8	1.1/2

JIC Male x JIC Female 45°

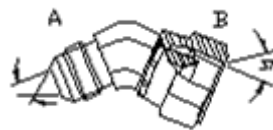

Code	JIC	JIC
S3J1J30707	7/16	7/16
S3J1J30909	9/16	9/16
S3J1J31212	3/4	3/4
S3J1J31414	7/8	7/8
S3J1J31717	1.1/16	1.1/16
S3J1J32121	1.5/16	1.5/16

JIC Male Tee

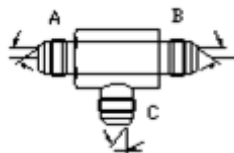

Code	JIC
S7J1J1J107	7/16
S7J1J1J109	9/16
S7J1J1J112	3/4
S7J1J1J114	7/8
S7J1J1J117	1.1/16
S7J1J1J121	1.5/16
S7J1J1J126	1.5/8
S7J1J1J130	1.7/8

JIC Male x JIC Female Branch Tee

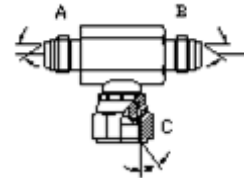

Code	JIC
S7J1J1J307	7/16
S7J1J1J309	9/16
S7J1J1J312	3/4
S7J1J1J314	7/8
S7J1J1J317	1.1/16
S7J1J1J321	1.5/16
S7J1J1J326	1.5/8

JIC Male x JIC Female Run Tee

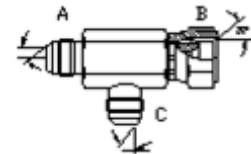

Code	JIC
S7J1J3J107	7/16
S7J1J3J108	1/2
S7J1J3J109	9/16
S7J1J3J112	3/4
S7J1J3J114	7/8
S7J1J3J117	1.1/16
S7J1J3J121	1.5/16
S7J1J3J126	1.5/8
S7J1J3J130	1.7/8

JIC Female x NPT Male

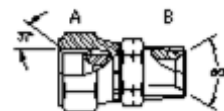

Code	JIC	NPT
SIJ3N10704	7/16	1/4
SIJ3N10904	9/16	1/4
SIJ3N11206	3/4	3/8
SIJ3N11408	7/8	1/2
SIJ3N12116	1.5/16	1"



DBF Stainless Fittings

Adaptors

JIC Hex Plug

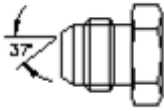

Code	JIC
S6J107	7/16
S6J108	1/2
S6J109	9/16
S6J112	3/4
S6J114	7/8
S6J117	1.1/16
S6J119	1.3/16
S6J121	1.5/16
S6J126	1.5/8

JIC Swivel Cap

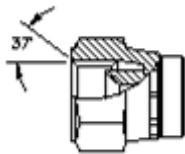

Code	JIC
S6J307	7/16
S6J308	1/2
S6J309	9/16
S6J312	3/4
S6J314	7/8
S6J317	1.1/16
S6J321	1.5/16
S6J326	1.5/8

DIN(L) Male x UNO Male

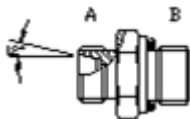

Code	Thread	UNO
S1M1U11407	14x1.5	7/16
S1M1U11807	18x1.5	7/16
S1M1U11809	18x1.5	9/16
S1M1U11812	18x1.5	3/4
S1M1U11814	18x1.5	7/8
S1M1U12614	26x1.5	7/8
S1M1U13017	30x2	1.1/16

DIN(H) Male x UNO Male

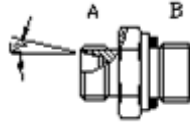

Code	Thread	UNO
S1M3U11809	18x1.5	9/16
S1M3U12414	24x1.5	7/8
S1M3U13012	30x2	3/4
S1M3U13017	30x2	1.1/16
S1M3U13617	36x2	1.1/16

NPT Male x NPT Male

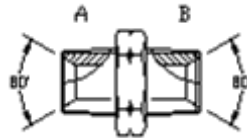

Code	NPT	NPT
S1N1N10202	1/8	1/8
S1N1N10204	1/8	1/4
S1N1N10206	1/8	3/8
S1N1N10404	1/4	1/4
S1N1N10406	1/4	3/8
S1N1N10408	1/4	1/2
S1N1N10412	1/4	3/4
S1N1N10606	3/8	3/8
S1N1N10608	3/8	1/2
S1N1N10612	3/8	3/4
S1N1N10808	1/2	1/2
S1N1N10812	1/2	3/4
S1N1N10816	1/2	1"
S1N1N11212	3/4	3/4
S1N1N11216	3/4	1"
S1N1N11220	3/4	1.1/4
S1N1N11616	1"	1"
S1N1N11620	1"	1.1/4
S1N1N11624	1"	1.1/2
S1N1N11632	1"	2"
S1N1N12020	1.1/4	1.1/4
S1N1N12024	1.1/4	1.1/2
S1N1N12424	1.1/2	1.1/2
S1N1N13232	2"	2"

NPT Reducing Bush

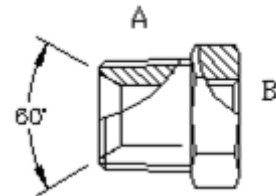

Code	NPT	NPT
S1N1N20402	1/4	1/8
S1N1N20604	3/8	1/4
S1N1N20802	1/2	1/8
S1N1N20804	1/2	1/4
S1N1N20806	1/2	3/8
S1N1N21206	3/4	3/8
S1N1N21208	3/4	1/2
S1N1N21604	1"	1/4
S1N1N21606	1"	3/8
S1N1N21608	1"	1/2
S1N1N21612	1"	3/4
S1N1N22012	1.1/4	3/4
S1N1N22016	1.1/4	1"
S1N1N22412	1.1/2	3/4
S1N1N22416	1.1/2	1"
S1N1N23208	2"	1/2
S1N1N23224	2"	1.1/2
S1N1N24832	3"	2"

NPT M&F Adaptor

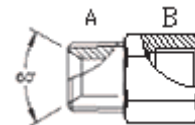

Code	NPT	NPT
S1N1N20202	1/8	1/8
S1N1N20404	1/4	1/4
S1N1N20406	1/4	3/8
S1N1N20408	1/4	1/2
S1N1N20606	3/8	3/8
S1N1N20808	1/2	1/2
S1N1N20812	1/2	3/4



DBF Stainless Fittings

Adaptors

NPT Hex Plug



Code	NPT
S6N102	1/8
S6N104	1/4
S6N106	3/8
S6N108	1/2
S6N112	3/4
S6N116	1"
S6N120	1.1/4
S6N124	1.1/2
S6N132	2"

NPT Internal Hex Plug



Code	NPT
S6N102SH	1/8
S6N104SH	1/4
S6N106SH	3/8
S6N108SH	1/2
S6N112SH	3/4
S6N116SH	1"
S6N120SH	1.1/4

NPT Female Socket

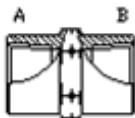

Code	NPT	NPT
S1N2N20202	1/8	1/8
S1N2N20204	1/8	1/4
S1N2N20404	1/4	1/4
S1N2N20406	1/4	3/8
S1N2N20606	3/8	3/8
S1N2N20808	1/2	1/2
S1N2N21212	3/4	3/4
S1N2N21616	1"	1"
S1N2N22020	1.1/4	1.1/4
S1N2N22424	1.1/2	1.1/2
S1N2N23232	2"	2"

NPT Male x NPSM Female

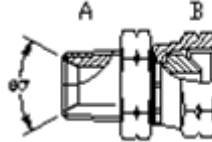

Code	NPT	NPSM
S1N1N30404	1/4	1/4
S1N1N30606	3/8	3/8
S1N1N31616	1"	1"

NPT Female Tee

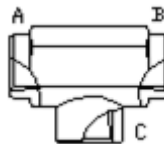

Code	NPT
S7N2N2N202	1/8
S7N2N2N204	1/4
S7N2N2N206	3/8
S7N2N2N208	1/2
S7N2N2N212	3/4
S7N2N2N216	1"
S7N2N2N224	1.1/2

NPT Blanking Cap

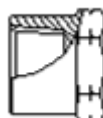

Code	NPT
S6N202	1/8
S6N220	1.1/4
S6N224	1.1/2

UNO Internal Hex Plug

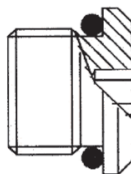

Code	UNO
S6U107SH	7/16
S6U109SH	9/16
S6U117SH	1.1/16

UNO Hex Plug

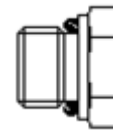

Code	UNO
S6U107	7/16
S6U108	1/2
S6U109	9/16
S6U112	3/4
S6U114	7/8
S6U117	1.1/16
S6U121	1.5/16
S6U126	1.5/8
S6U130	1.7/8

JIC Nut & Sleeve



Code	Tube	JIC
75-SZJ304	1/4	7/16
75-SZJ306	3/8	9/16
75-SZJ308	1/2	3/4
75-SZJ310	5/8	7/8
75-SZJ312	3/4	1.1/16
75-SZJ316	1"	1.5/16

Bonded (Dowty) Deals



Code	Thread
75-SDS04	1/4
75-SDS06	3/8
75-SDS08	1/2
75-SDS12	3/4
75-SDS16	1"



DBF Stainless Fittings

DBF Products Also Available

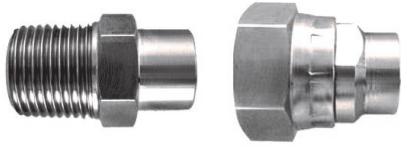

Convoluted Hose Ends with BSP, NPT and JIC threads



BSP to NPT Adaptors

Other Stainless Steel Products Available



TWIN FERRULE TUBE FITTINGS



BITE TYPE TUBE FITTINGS



INSTRUMENTATION VALVES

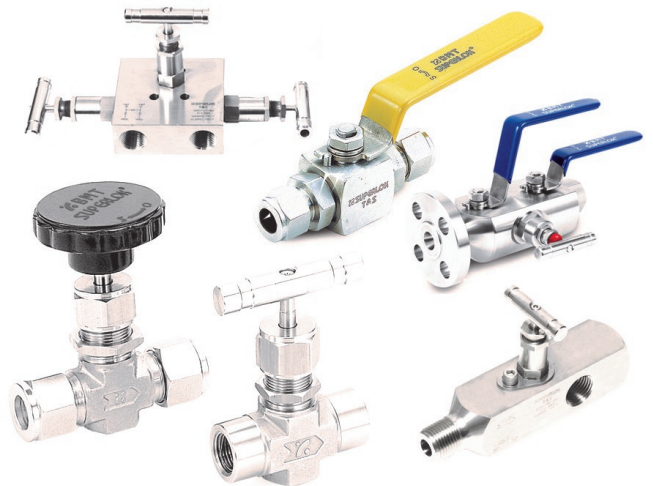

150LB Screwed Fittings



Multi Stala Storage System (Category 77)

Multi-Stala is a transparent multi-purpose storage system. It is ideal for storing parts in warehouses, laboratories, electronic plants, hospitals and general stores. Multi-Stala is easily transported and assembled and can be readily removed for cleaning. It can also be assembled as a portable hand held unit or as parts storage racking in a service vehicle.

77-MS9 (9 Compartments)



600mm x 77mm x 62mm

77-MS6 (6 Compartments)



600mm x 113mm x 91mm

77-MS5 (5 Compartments)



600mm x 164mm x 133mm

77-MS4 (4 Compartments)

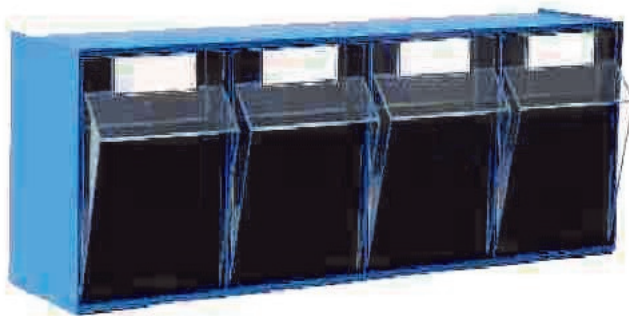

600mm x 207mm x 168mm

77-MS3 (3 Compartments)

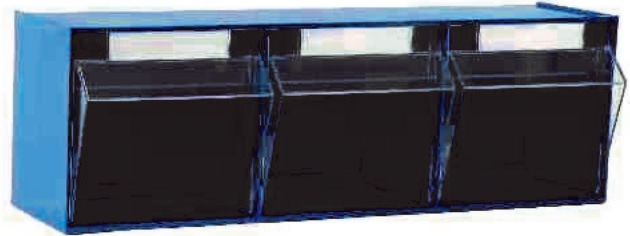

600mm x 240mm x 197mm

77-MS2 (2 Compartments)



600mm x 353mm x 299mm

Wall Frames & Bolts

Code	Height (mm)
77-WF06	600mm
77-WF12	1200mm



77-MSB (Bolt & Lock Set)



Available in Blue or Beige.

Made in Germany.



Mobile
Trolleys
now
available



D.O.T. Push-in Fittings (Category 88)



QAF3
Male
Connector

Code	Tube	Male
88-003-02501	5/32	1/16 NPT
88-003-02502	5/32	1/8 NPT
88-003-0302	3/16	1/8 NPT
88-003-0402	1/4	1/8 NPT
88-003-0404	1/4	1/4 NPT
88-003-0406	1/4	3/8 NPT
88-003-0408	1/4	1/2 NPT
88-003-04M12	1/4	M12x1.5
88-003-0602	3/8	1/8 NPT
88-003-0604	3/8	1/4 NPT
88-003-0606	3/8	3/8 NPT
88-003-0608	3/8	1/2 NPT
88-003-0612	3/8	3/4 NPT
88-003-06M12	3/8	M12x1.5
88-003-06M14	3/8	M14x1.5
88-003-06M16	3/8	M16x1.5
88-003-06M22	3/8	M22x1.5
88-003-0804	1/2	1/4 NPT
88-003-0806	1/2	3/8 NPT
88-003-0808	1/2	1/2 NPT
88-003-08M16	1/2	M16x1.5
88-003-1006	5/8	3/8 NPT
88-003-1008	5/8	1/2 NPT
88-003-1012	5/8	3/4 NPT
88-003-1208	3/4	1/2 NPT
88-003-1212	3/4	3/4 NPT
88-M003-0602	6mm	1/8 BSPT
88-M003-0604	6mm	1/4 BSPT
88-M003-06M10	6mm	M10x1.0
88-M003-06M12	6mm	M12x1.5
88-M003-06M14	6mm	M14x1.5
88-M003-06M16	6mm	M16x1.5
88-M003-06M22	6mm	M22x1.5
88-M003-06N02	6mm	1/8 NPT
88-M003-06N04	6mm	1/4 NPT
88-M003-06N06	6mm	3/8 NPT
88-M003-06N08	6mm	1/2 NPT



QAF3
Male
Connector
(cont)

Code	Tube	Male
88-M003-0802	8mm	1/8 BSPT
88-M003-0804	8mm	1/4 BSPT
88-M003-0806	8mm	3/8 BSPT
88-M003-0808	8mm	1/2 BSPT
88-M003-08M10	8mm	M10x1.0
88-M003-08M12	8mm	M12x1.5
88-M003-08M14	8mm	M14x1.5
88-M003-08M16	8mm	M16x1.5
88-M003-08M22	8mm	M22x1.5
88-M003-08N02	8mm	1/8 NPT
88-M003-08N04	8mm	1/4 NPT
88-M003-08N06	8mm	3/8 NPT
88-M003-1004	10mm	1/4 BSPT
88-M003-1006	10mm	3/8 BSPT
88-M003-10M10	10mm	M10x1.0
88-M003-10M12	10mm	M12x1.5
88-M003-10M14	10mm	M14x1.5
88-M003-10M16	10mm	M16x1.5
88-M003-10M22	10mm	M22x1.5
88-M003-10N04	10mm	1/4 NPT
88-M003-10N06	10mm	3/8 NPT
88-M003-10N08	10mm	1/2 NPT
88-M003-1204	12mm	1/4 BSPT
88-M003-1206	12mm	3/8 BSPT
88-M003-1208	12mm	1/2 BSPT
88-M003-12M12	12mm	M12x1.5
88-M003-12M14	12mm	M14x1.5
88-M003-12M16	12mm	M16x1.5
88-M003-12M22	12mm	M22x1.5
88-M003-12N04	12mm	1/4 NPT
88-M003-12N06	12mm	3/8 NPT
88-M003-12N08	12mm	1/2 NPT
88-M003-16M16	16mm	M16x1.5
88-M003-16M22	16mm	M22x1.5



QAF4
Double
Union

Code	Tube
88-004-025	5/32
88-004-03	3/16
88-004-04	1/4
88-004-06	3/8
88-004-08	1/2
88-004-10	5/8
88-M004-04	4mm
88-M004-06	6mm
88-M004-08	8mm
88-M004-09	9mm
88-M004-10	10mm
88-M004-11	11mm
88-M004-12	12mm
88-M004-15	15mm
88-M004-16	16mm



QAF5
Fixed Male
Elbow Connector

Code	Tube	Male
88-005-02502	5/32	1/8 NPT
88-005-0302	3/16	1/8 NPT
88-005-0402	1/4	1/8 NPT
88-005-0404	1/4	1/4 NPT
88-005-0406	1/4	3/8 NPT
88-005-0602	3/8	1/8 NPT
88-005-0604	3/8	1/4 NPT
88-005-0606	3/8	3/8 NPT
88-005-0608	3/8	1/2 NPT
88-005-0804	1/2	1/4 NPT
88-005-0806	1/2	3/8 NPT
88-005-0808	1/2	1/2 NPT
88-005-1006	5/8	3/8 NPT
88-005-1008	5/8	1/2 NPT
88-005-1208	3/4	1/2 NPT
88-M005-0602	6mm	1/8 BSPT
88-M005-06N02	6mm	1/8 NPT
88-M005-06N04	6mm	1/4 NPT
88-M005-06N06	6mm	3/8 NPT
88-M005-0806	8mm	3/8 BSPT
88-M005-08N02	8mm	1/8 NPT
88-M005-1004	10mm	1/4 BSPT
88-M005-10N06	10mm	3/8 NPT
88-M005-1204	12mm	1/4 BSPT
88-M005-1206	12mm	3/8 BSPT
88-M005-1208	12mm	1/2 BSPT
88-M005-12N04	12mm	1/4 NPT
88-M005-12N06	12mm	3/8 NPT



D.O.T. Push-in Fittings (Category 88)



QAF5S
Swivel Male
Elbow

Code	Tube	Male
88-005S-0402	1/4	1/8 NPT
88-005S-0404	1/4	1/4 NPT
88-005S-0406	1/4	3/8 NPT
88-005S-0408	1/4	1/2 NPT
88-005S-0602	3/8	1/8 NPT
88-005S-0604	3/8	1/4 NPT
88-005S-0606	3/8	3/8 NPT
88-005S-0608	3/8	1/2 NPT
88-005S-06M12	3/8	M12x1.5
88-005S-06M14	3/8	M14x1.5
88-005S-06M16	3/8	M16x1.5
88-005S-06M22	3/8	M22x1.5
88-005S-0804	1/2	1/4 NPT
88-005S-0806	1/2	3/8 NPT
88-005S-0808	1/2	1/2 NPT
88-005S-1006	5/8	3/8 NPT
88-005S-1008	5/8	1/2 NPT
88-005S-1012	5/8	3/4 NPT
88-005S-1208	3/4	1/2 NPT
88-005S-1212	3/4	3/4 NPT
88-M005S-0602	6mm	1/8 BSPT
88-M005S-0604	6mm	1/4 BSPT
88-M005S-06M10	6mm	M10x1.0
88-M005S-06M12	6mm	M12x1.5
88-M005S-06M16	6mm	M16x1.5
88-M005S-06M22	6mm	M22x1.5
88-M005S-06N02	6mm	1/8 NPT
88-M005S-06N04	6mm	1/4 NPT
88-M005S-06N06	6mm	3/8 NPT
88-M005S-0804	8mm	1/4 BSPT
88-M005S-0806	8mm	3/8 BSPT
88-M005S-08M12	8mm	M12x1.5
88-M005S-08M16	8mm	M16x1.5
88-M005S-08M22	8mm	M22x1.5
88-M005S-08N04	8mm	1/4 NPT
88-M005S-08N06	8mm	3/8 NPT
88-M005S-08N08	8mm	1/2 NPT
88-M005S-1004	10mm	1/4 BSPT
88-M005S-1006	10mm	3/8 BSPT
88-M005S-10M12	10mm	M12x1.5
88-M005S-10M16	10mm	M16x1.5
88-M005S-10M22	10mm	M22x1.5
88-M005S-10N04	10mm	1/4 NPT
88-M005S-10N06	10mm	3/8 NPT
88-M005S-10N08	10mm	1/2 NPT
88-M005S-1204	12mm	1/4 BSPT
88-M005S-1206	12mm	3/8 BSPT
88-M005S-1208	12mm	1/2 BSPT
88-M005S-12M12	12mm	M12x1.5
88-M005S-12M16	12mm	M16x1.5
88-M005S-12M22	12mm	M22x1.5
88-M005S-12N04	12mm	1/4 NPT
88-M005S-12N06	12mm	3/8 NPT
88-M005S-12N08	12mm	1/2 NPT
88-M005S-16M22	16mm	M22x1.5



QAF5D
Fixed 45° Male
Elbow Connector

Code	Tube	Male
88-005D-0402	1/4	1/8 NPT
88-005D-0404	1/4	1/4 NPT
88-005D-0406	1/4	3/8 NPT
88-005D-0602	3/8	1/8 NPT
88-005D-0604	3/8	1/4 NPT
88-005D-0606	3/8	3/8 NPT
88-005D-0608	3/8	1/2 NPT
88-005D-0804	1/2	1/4 NPT
88-005D-0806	1/2	3/8 NPT
88-005D-0808	1/2	1/2 NPT
88-005D-1006	5/8	3/8 NPT
88-005D-1008	5/8	1/2 NPT



QAF5DS
Swivel 45°
Male Elbow

Code	Tube	Male
88-005DS-0402	1/4	1/8 NPT
88-005DS-0404	1/4	1/4 NPT
88-005DS-0604	3/8	1/4 NPT
88-005DS-0606	3/8	3/8 NPT
88-005DS-0804	1/2	1/4 NPT
88-005DS-0806	1/2	3/8 NPT
88-005DS-0808	1/2	1/2 NPT
88-005DS-1008	5/8	1/2 NPT
88-005DS-1208	3/4	1/2 NPT

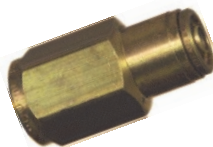

QAF10
Female
Connector

Code	Tube	Female
88-010-02502	5/32	1/8 NPT
88-010-0302	3/16	1/8 NPT
88-010-0402	1/4	1/8 NPT
88-010-0404	1/4	1/4 NPT
88-010-04M12	1/4	M12x1.5
88-010-0604	3/8	1/4 NPT
88-010-0606	3/8	3/8 NPT
88-010-0608	3/8	1/2 NPT
88-010-0804	1/2	1/4 NPT
88-010-0806	1/2	3/8 NPT
88-010-0808	1/2	1/2 NPT



QAF11
Union
Elbow

Code	Tube
88-011-04	1/4
88-011-06	3/8
88-011-08	1/2
88-M011-04	4mm
88-M011-06	6mm
88-M011-08	8mm
88-M011-10	10mm
88-M011-12	12mm

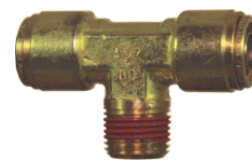

QAF12
Fixed Male
Branch Tee

Code	Tube	Male
88-012-0402	1/4	1/8 NPT
88-012-0404	1/4	1/4 NPT
88-012-0602	3/8	1/8 NPT
88-012-0604	3/8	1/4 NPT
88-012-0606	3/8	3/8 NPT
88-012-0806	1/2	3/8 NPT
88-012-0808	1/2	1/2 NPT



QAF12S
Swivel Male
Branch Tee

Code	Tube	Male
88-012S-0402	1/4	1/8 NPT
88-012S-0404	1/4	1/4 NPT
88-012S-0406	1/4	3/8 NPT
88-012S-0602	3/8	1/8 NPT
88-012S-0604	3/8	1/4 NPT
88-012S-0606	3/8	3/8 NPT
88-012S-06M22	3/8	M22x1.5
88-012S-0804	1/2	1/4 NPT
88-012S-0806	1/2	3/8 NPT
88-012S-0808	1/2	1/2 NPT
88-M012S-06M12	6mm	M12x1.5
88-M012S-06N02	6mm	1/8 NPT
88-M012S-06N04	6mm	1/4 NPT
88-M012S-08N04	8mm	1/4 NPT
88-M012S-10M16	10mm	M16x1.5
88-M012S-10N04	10mm	1/4 NPT
88-M012S-12M16	12mm	M16x1.5
88-M012S-12M22	12mm	M22x1.5
88-M012S-12N04	12mm	1/4 NPT

D.O.T. Push-in Fittings (Category 88)



QAF12FS
Swivel Female
Branch Tee

Code	Tube	Female
88-012FS-0604	3/8	1/4 NPT

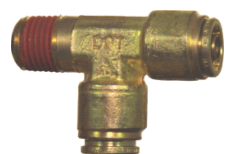

QAF13
Fixed Male
Run Tee

Code	Tube	Male
88-013-0402	1/4	1/8 NPT
88-013-0404	1/4	1/4 NPT
88-013-0604	3/8	1/4 NPT
88-013-0606	3/8	3/8 NPT
88-013-0806	1/2	3/8 NPT



QAF13S
Swivel Male
Run Tee

Code	Tube	Male
88-013S-0402	1/4	1/8 NPT
88-013S-0404	1/4	1/4 NPT
88-013S-0604	3/8	1/4 NPT
88-013S-0606	3/8	3/8 NPT
88-013S-0804	1/2	1/4 NPT
88-013S-0806	1/2	3/8 NPT
88-013S-0808	1/2	1/2 NPT
88-M013S-06M12	6mm	M12x1.5
88-M013S-10M16	10mm	M16x1.5
88-M013S-12M16	12mm	M16x1.5
88-M013S-12M22	12mm	M22x1.5



QAF14
Union
Tee

Code	Tube
88-014-04	1/4
88-014-06	3/8
88-014-08	1/2
88-014-10	5/8
88-M014-04	4mm
88-M014-06	6mm
88-M014-08	8mm
88-M014-10	10mm
88-M014-12	12mm



QAF15
Fixed Female
Elbow Connector

Code	Tube	Female
88-015-0402	1/4	1/8 NPT
88-015-0404	1/4	1/4 NPT
88-015-0604	3/8	1/4 NPT
88-015-0606	3/8	3/8 NPT
88-015-0806	1/2	3/8 NPT
88-015-0808	1/2	1/2 NPT



QAF15S
Swivel Fem
Elbow

Code	Tube	Female
88-015S-0604	3/8	1/4 NPT

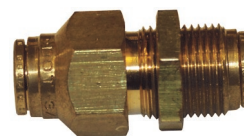

QAF31
Bulkhead
Union

Code	Tube
88-031-04	1/4
88-031-06	3/8
88-031-08	1/2
88-M031-06	6mm



QAF31F
B/head Female
Connector

Code	Tube	Female
88-031F-0404	1/4	1/4 NPT
88-031F-0606	3/8	3/8 NPT
88-031F-0808	1/2	1/2 NPT



QAF65
Tube Plug

Code	Tube
88-065-06	3/8
88-065-08	1/2

Other Airbrake Products Available

- Nylon Airbrake Tube
- Suzi Coils
- Electro Coils
- NTA / 1460 Series Airbrake Fittings
- PBR Style Airbrake Fittings
- Westinghouse Style Airbrake Fittings
- Brass Adaptors in NPT, Metric and BSP Threads
- CA93 Series Airbrake Couplers
- Gladhand Couplers



INDUSTRIAL FITTINGS SALES
(VIC) Pty. Ltd. ABN 12 051 387 029



16-18 Smeaton Avenue, Dandenong South. Victoria 3175
Phone (03) 8770 1333 Fax (03) 8770 1313
Email : sales@ifsvic.com.au



INDUSTRIAL FITTINGS SALES
(VIC) Pty. Ltd. ABN 12 051 387 029



TERMS AND CONDITIONS OF SALE

1. General

- (a) In these conditions "The Company" means Industrial Fittings Sales (Vic) Pty Ltd.
- (b) These Terms and Conditions cancel any previously published by the Company.

2. Pricing

- (a) The prices contained in the price list are based upon current costs at the time of publication and are subject to alteration without prior notice to the buyer.
- (b) Unless subject to a prior quotation, any prices given for supply of goods will only be valid for a period of 30 days.
- (c) The prices contained in the price list do not include G.S.T. which will be charged to the buyer at time of sale unless an appropriate exemption is quoted.

3. Payment (Account Customers)

- (a) Invoices will be payable within 30 days of statement date.
- (b) Unless otherwise agreed to by a duly authorized employee of the Company, if payments are not received within 45 days of statement date, credit facilities may be suspended without notice.
- (c) Unless otherwise agreed to by a Company Director, if payment is not received within 60 days of statement date, credit facilities may be withdrawn until the entire account is paid.
- (d) Any payment outstanding more than 90 days from statement date will be subject to an interest charge equivalent to the current overdraft rate of the National Australia Bank.

4. Credit Claims>Returns

- (a) Claims for shortages or incorrect deliveries will not be recognized unless made within five working days of receipt of goods.
- (b) Claims for non-delivery must be made within ten working days of Statement date.
- (c) Claims will not be recognized unless invoice number is quoted.
- (d) All goods being returned must be accompanied by a pre-arranged credit authorization number.
- (e) Goods specially ordered or manufactured to customer specifications will not be accepted for credit.
- (f) Goods specially cut to length or modified by request will not be accepted for credit.
- (g) Goods accepted by the Company as faulty will be credited at invoice value or replaced.
- (h) Freight charges on any goods returned will be the responsibility of the Purchaser unless otherwise agreed to by the Company prior to the return.
- (i) Any goods returned for credit, other than faulty or incorrectly delivered items, may at the Company's discretion, be subject to a restocking fee.

5. Title

- (a) Ownership of the goods sold will not pass until the Company receives all outstanding monies due in full, although risk in the goods will pass on delivery.

6. Liability

- (a) Where it is agreed that goods are faulty due to manufacture or materials, the liability (if any) of the Company shall, to the extent allowed by the Trade Practices Act, be limited to the replacement or repair of the goods, or a refund of the purchase price and shall not extend to any consequential loss or damage incurred by any person.

7. Delivery

- (a) Unless otherwise agreed, a freight charge will be made on each delivery unless the goods are despatched on the purchaser's carrier. Back orders will be delivered at the Company's expense.
- (b) No responsibility will be accepted for breakage, damage or loss in transit.